



This is a digital copy of a book that was preserved for generations on library shelves before it was carefully scanned by Google as part of a project to make the world's books discoverable online.

It has survived long enough for the copyright to expire and the book to enter the public domain. A public domain book is one that was never subject to copyright or whose legal copyright term has expired. Whether a book is in the public domain may vary country to country. Public domain books are our gateways to the past, representing a wealth of history, culture and knowledge that's often difficult to discover.

Marks, notations and other marginalia present in the original volume will appear in this file - a reminder of this book's long journey from the publisher to a library and finally to you.

### **Usage guidelines**

Google is proud to partner with libraries to digitize public domain materials and make them widely accessible. Public domain books belong to the public and we are merely their custodians. Nevertheless, this work is expensive, so in order to keep providing this resource, we have taken steps to prevent abuse by commercial parties, including placing technical restrictions on automated querying.

We also ask that you:

- + *Make non-commercial use of the files* We designed Google Book Search for use by individuals, and we request that you use these files for personal, non-commercial purposes.
- + *Refrain from automated querying* Do not send automated queries of any sort to Google's system: If you are conducting research on machine translation, optical character recognition or other areas where access to a large amount of text is helpful, please contact us. We encourage the use of public domain materials for these purposes and may be able to help.
- + *Maintain attribution* The Google "watermark" you see on each file is essential for informing people about this project and helping them find additional materials through Google Book Search. Please do not remove it.
- + *Keep it legal* Whatever your use, remember that you are responsible for ensuring that what you are doing is legal. Do not assume that just because we believe a book is in the public domain for users in the United States, that the work is also in the public domain for users in other countries. Whether a book is still in copyright varies from country to country, and we can't offer guidance on whether any specific use of any specific book is allowed. Please do not assume that a book's appearance in Google Book Search means it can be used in any manner anywhere in the world. Copyright infringement liability can be quite severe.

### **About Google Book Search**

Google's mission is to organize the world's information and to make it universally accessible and useful. Google Book Search helps readers discover the world's books while helping authors and publishers reach new audiences. You can search through the full text of this book on the web at <http://books.google.com/>

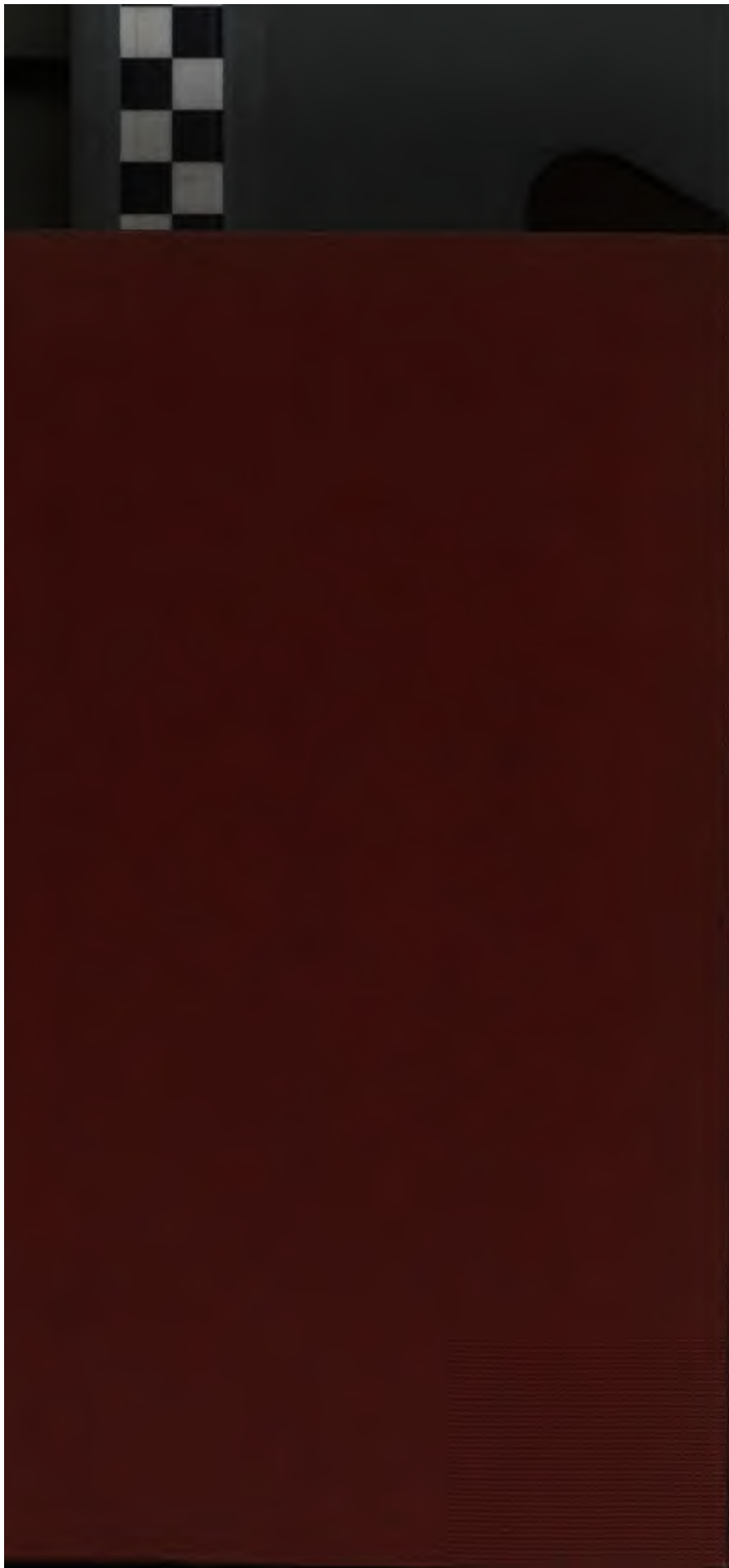

**LANE**

**MEDICAL**



**LIBRARY**

**LEVI COOPER LANE FUND**

*Gift  
Carnegie Institution*

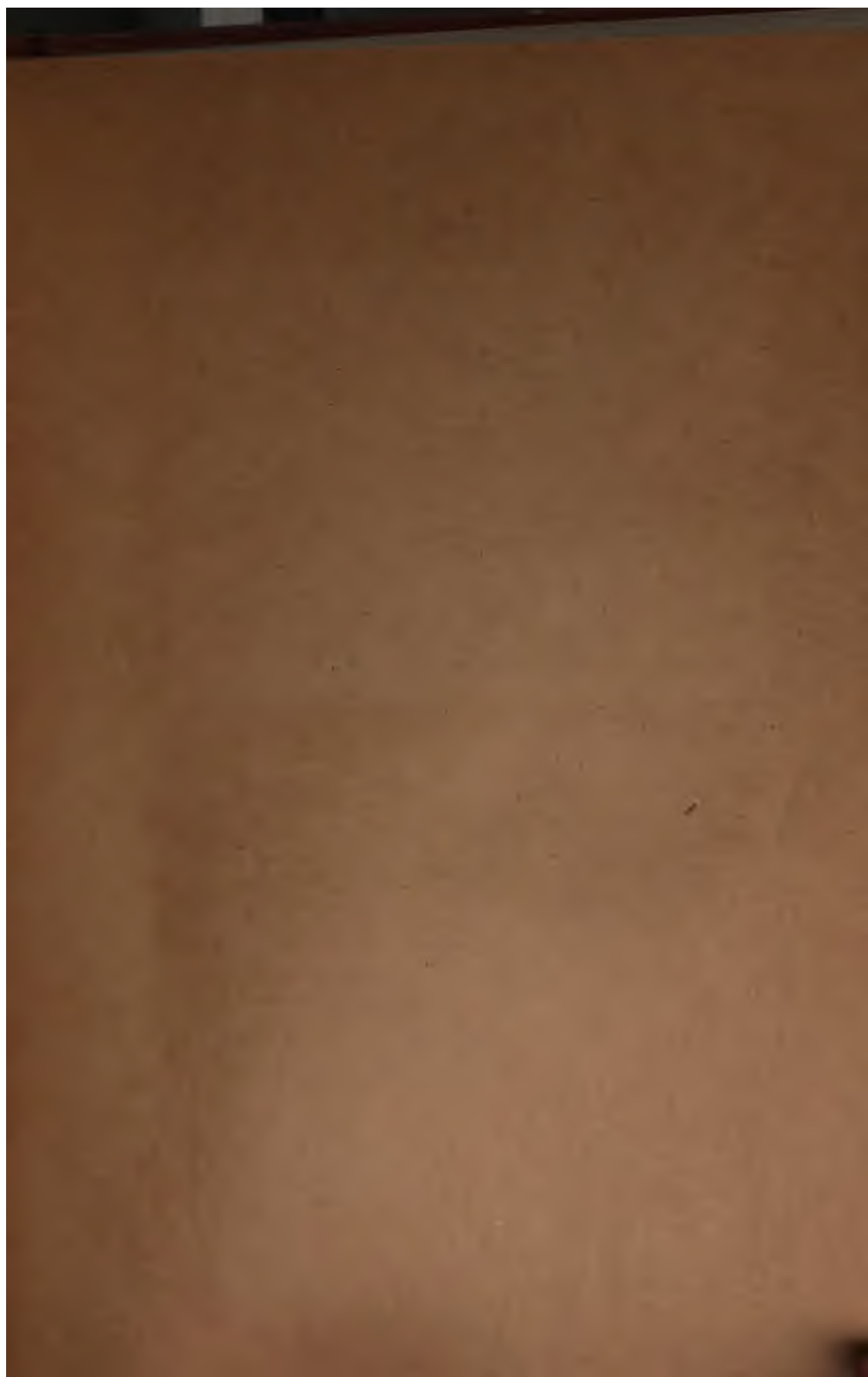



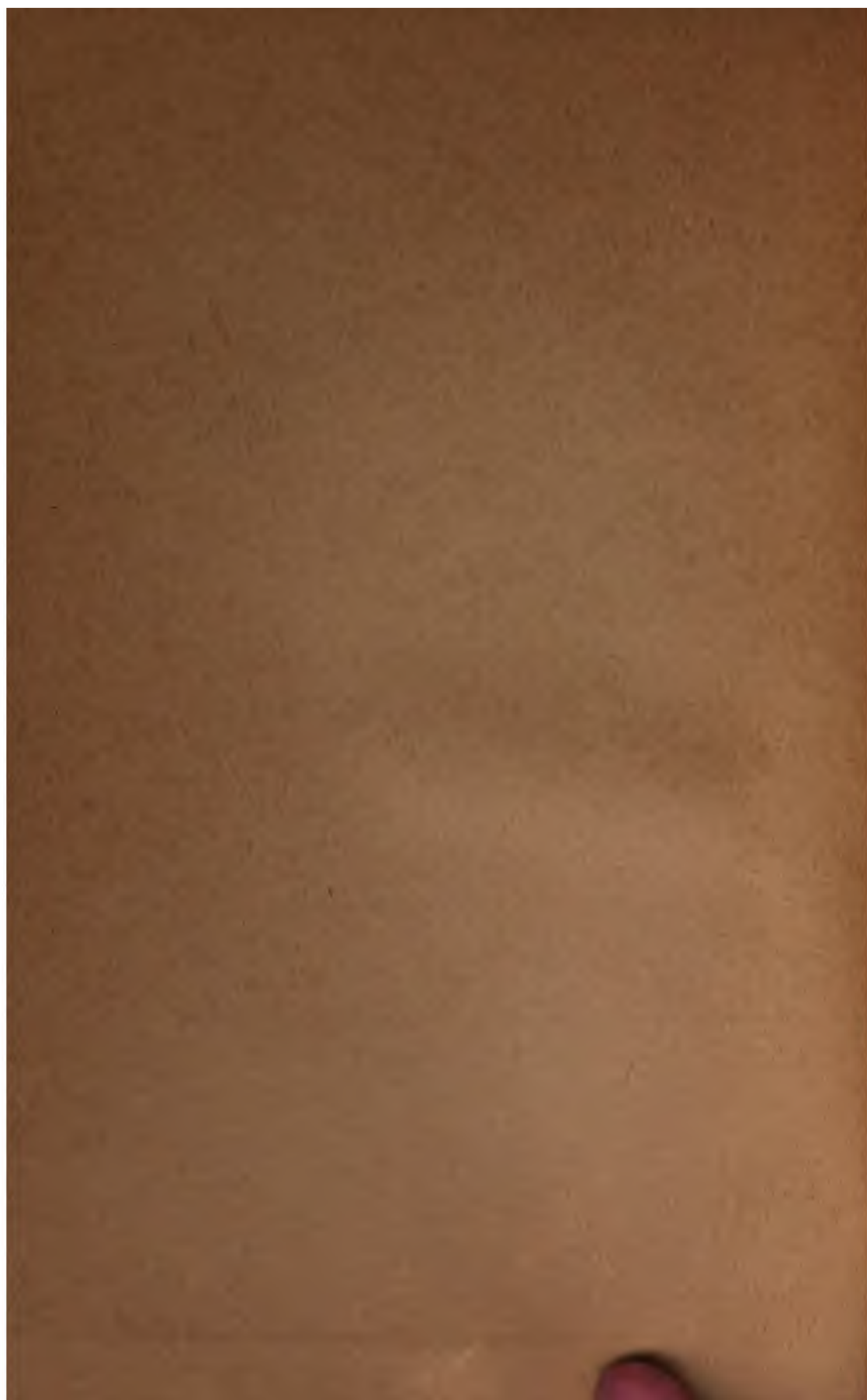

# NAVAL OFFICERS

## THEIR HEREDITY AND DEVELOPMENT

BY

CHARLES BENEDICT DAVENPORT

DIRECTOR OF DEPARTMENT OF EXPERIMENTAL EVOLUTION AND OF THE  
EUGENICS RECORD OFFICE,  
CARNEGIE INSTITUTION OF WASHINGTON

ASSISTED BY

MARY THERESA SCUDDER

RESEARCH COLLABORATOR IN THE  
CARNEGIE INSTITUTION OF WASHINGTON



LABOR LIBRARY

PUBLISHED BY THE CARNEGIE INSTITUTION OF WASHINGTON  
WASHINGTON, 1919

79

CARNEGIE INSTITUTION OF WASHINGTON  
PUBLICATION No. 259

PAPER No. 29 OF THE STATION FOR EXPERIMENTAL EVOLUTION AT  
COLD SPRING HARBOR, NEW YORK

YASBIL: 33A1

THE PLIMPTON PRESS  
MORWOOD MASS U.S.A

no. 2  
1919

## TABLE OF CONTENTS.

### PART I.

	PAGE
I. STATEMENT OF PROBLEM . . . . .	1
II. AN IMPROVED METHOD OF TESTING THE FITNESS OF UNTRIED OFFICERS . . . . .	2
1. General Considerations . . . . .	2
2. Special Procedure . . . . .	3
III. RESULTS OF STUDY . . . . .	4
1. Types of Naval Officers . . . . .	4
2. Temperament in Relation to Type . . . . .	4
3. Juvenile Promise of Naval Officers of the Various Types . . . . .	6
Fighters . . . . .	6
Strategists . . . . .	7
Administrators . . . . .	7
Explorers . . . . .	8
Adventurers . . . . .	8
Conclusion as to Juvenile Promise . . . . .	8
4. The Hereditary Traits of Naval Officers . . . . .	9
General . . . . .	9
The Inheritance of Special Traits . . . . .	25
Thalassophilia, or Love of the Sea . . . . .	25
Source of Thalassophilia (or Sea-lust) in Naval Officers . . . . .	25
Heredity of Sea-lust . . . . .	27
The Hyperkinetic Qualities of the Fighters . . . . .	29
Source of Nomadism in Naval Officers . . . . .	31
IV. CONCLUSIONS . . . . .	33
V. APPLICATION OF PRINCIPLES TO SELECTION OF UNTRIED MEN . . . . .	33

### PART II.

#### BRIEF BIOGRAPHIES OF NAVAL OFFICERS, WITH ESPECIAL REFERENCE TO THEIR JUVENILE PROMISE AND THEIR PERSONAL TRAITS.

	PAGE
1. William Bainbridge . . . . .	36
2. Joshua Barney . . . . .	37
3. John Barry . . . . .	40
4. Philip Beaver . . . . .	41
5. Charles William de la Poer Beresford . . . . .	42
6. George Smith Blake . . . . .	44
7. Robert Blake . . . . .	47
8. Jahleel Brenton . . . . .	49
9. Moses Brown . . . . .	51
10. Franklin Buchanan . . . . .	53
11. Thomas Cochrane . . . . .	56
12. Cuthbert Collingwood . . . . .	59
13. William Barker Cushing . . . . .	60
14. John Adolf Dahlgren . . . . .	64

**TABLE OF CONTENTS**

**PART II.—CONTINUED**

	<b>PAGE</b>
15. Stephen Decatur . . . . .	68
16. George Dewey . . . . .	70
17. Adam Duncan . . . . .	74
18. George Keith Elphinstone . . . . .	76
19. David Glasgow Farragut . . . . .	79
20. Matthew Flinders . . . . .	83
21. Andrew Hull Foote . . . . .	86
22. Ebenezer Fox . . . . .	90
23. John Franklin . . . . .	91
24. Thomas Masterman Hardy . . . . .	93
25. Edward Hawke . . . . .	95
26. John Hawkins . . . . .	96
27. Essek Hopkins . . . . .	98
28. Geoffrey Thomas Phipps Hornby . . . . .	100
29. William Hoste . . . . .	103
30. Richard Howe . . . . .	104
31. John Jervis . . . . .	107
32. Catesby ap Roger Jones . . . . .	109
33. John Paul Jones . . . . .	112
34. Henry Keppel . . . . .	114
35. James Lawrence . . . . .	118
36. Thomas Macdonough . . . . .	120
37. John Newland Maffitt . . . . .	122
38. Alfred Mahan . . . . .	125
39. John Markham . . . . .	127
40. Frederick Marryat . . . . .	129
41. Francis Leopold McClintock . . . . .	131
42. Fairfax Moresby . . . . .	133
43. Charles Morris . . . . .	134
44. Horatio Nelson . . . . .	137
45. Jeremiah O'Brien . . . . .	148
46. William Harwar Parker . . . . .	151
47. Hiram Paulding . . . . .	154
48. Edward Pellew . . . . .	157
49. George Hamilton Perkins . . . . .	160
50. Perry family . . . . .	162
51. John Woodward Phillip . . . . .	172
52. Arthur Phillip . . . . .	174
53. Porter family . . . . .	175
54. Edward Preble . . . . .	181
55. Walter Raleigh . . . . .	185
56. John Rodgers . . . . .	187
57. George Brydges Rodney . . . . .	192
58. Joshua Ratoon Sands . . . . .	193
59. James Saumarez . . . . .	196
60. Raphael Semmes . . . . .	198
61. Edward Hobart Seymour . . . . .	200
62. William Sidney Smith . . . . .	201
63. Robert Field Stockton . . . . .	203
64. Josiah Tattnall . . . . .	207
65. Marten Harperts Tromp . . . . .	210
66. John Randolph Tucker . . . . .	211
67. John Ancrum Winalow . . . . .	212
68. William Walseley . . . . .	214

---

**NAVAL OFFICERS**  
**THEIR HEREDITY AND DEVELOPMENT**

**BY**  
**CHARLES BENEDICT DAVENPORT**

**ASSISTED BY**  
**MARY THERESA SCUDDER**

---





## PART I.

### I. STATEMENT OF THE PROBLEM.

A nation at the beginning of a great war, after prolonged peace, is executing a great increase of its naval and military forces. For these forces officers must be selected in large numbers, as many as 1,000 officers for each division of 20,000 men, or 50,000 officers for 1,000,000 men. So, too, in the naval organization every ship has its commander and lieutenants, and there are captains and admirals of the various grades for the command of groups of officers. Each of these officers holds in his hands, as it were, the lives of from 100 to 100,000 men. Obviously it is a matter of the gravest concern that they should be properly selected. Yet the number is so vast and the personal knowledge about the appointee on the part of those who must appoint is necessarily often so slight that every assistance in the general method of making the selection may well be carefully considered. In time of actual battling, selection for advancement is made on the ground of performance — the inferior officers fail, the successful ones are given the higher commands. Our Civil War showed this clearly. It also showed the melancholy fact that the selections made at the outset were often inadequate, and many a colonel and even general confidently appointed at the outbreak of the war was recalled as a failure. The method of selecting exclusively by trial and error is a sure method, but one that is frightfully wasteful of lives and property. What is the best method of selecting untried men for positions as officers?

Diverse methods of selecting *untried* officers have been employed in the past. In the navy those who have made good records at the Naval Academy have been selected. Admission to the Academy is ordinarily made on the recommendation of a congressman. The applicant undergoes a physical and perhaps a mental examination. No doubt it is true, as Filchett (1903, p. 3) says: "In these days where the foot rule and the stethoscope and the examination paper are the tests by which our embryo Nelsons and Wellingtons are chosen, the future hero of the Nile and of Trafalgar would infallibly have been rejected." A war may be lost by rejection on a physical examination as certainly as by inadequacy in the supply of men or munitions. All too much is made of the physical examination; all too little of temperament and intelligence. The modern psychological and psychiatric examinations of officers and recruits are excellent. I recall one instance in our Civil War when a colonel ordered a futile attack in which a regiment was nearly annihilated. Investigation quickly showed that the commander was insane and had been so for some time. On the other hand, the elimination of the feeble-minded must be made intelligently. There is at least one instance in our Civil War where a feeble-minded sharpshooter did great execution. A feeble-minded man *may* have fired the musket shot that killed the great Nelson. Fighting leaders must possess insight, judgment, audacity, and pertinacity. Sharpshooters require little of these qualities, but above all ability to aim

accurately and quickly. Each man should be selected for the qualities that fit him for the special rôle he has to play. Joseph Jefferson would have failed as Hamlet. Many a perfect physical specimen of a man would make a poor naval strategist.

It is undoubtedly true, also, that at the outbreak of our Civil War many untried men were chosen as officers merely because they had shown some interest in the organization of companies and, moreover, were friends of congressmen who urged their appointment upon the War Department. We are told that in selection for the present war no political influence is permitted. But political influence is a most insidious thing; often it comes to the harassed Army Department as a welcome and valued suggestion. With the best intentions in the world the recommender may be urging an utterly unfit appointment. It is the insufficiency of the method that is at fault. Is there any additional test of fitness?<sup>1</sup>

## II. AN IMPROVED METHOD OF TESTING THE FITNESS OF UNTRIED OFFICERS.

### 1. GENERAL CONSIDERATIONS.

We start with the principle enunciated by Mahan: "Each man has his special gift and to succeed must act in accordance with it." Our problem is, then, how can we determine, in advance, what is a man's special gift? Or, in our special case, how can we tell whether or not an applicant for admission to the Naval Academy or for a naval commission has a gift for the place he seeks?

"The child is father of the man." Each well-marked trait of adult character passes through developmental stages. Its beginnings are already to be seen in the child. We recognize this fact in the case of physical traits. The dark skin-color of the negro develops rapidly, beginning a few hours after birth; curliness of hair shows in the first permanent coat; hair-color is slower in getting its final shade, but usually does so within the first decade. Mental traits, also, early show their quality. Imbeciles show retardation even at 5 or 6 years; idiots much earlier. On the other hand, Galton at 4 years had the intellectual advancement of a boy of 8 years. Special traits, as every experienced parent knows, may show at a very early age, such as neatness, altruism, frankness, jollity, cautiousness. Audacity in the adult is foreshadowed by adventurousness — a desire of the boy to "try stunts." The courageous man was fearless as a boy. In the early years of school special interests and capacities for drawing, arithmetical work, memorizing, reasoning, are clearly shown. The visualist and auditist are already differentiated long before adolescence. The significance of the combination of boyish traits may not be fully realized even by the parents or other close relatives; their interpretation has to be made by the expert. "What has poor little Horatio done," cried his uncle, Captain Suckling, when young Nelson was brought to him, at 12 years, to be taken on his ship, "that he, being so weak, should be sent to rough it at sea? But let him come, and if a cannon ball takes off his

<sup>1</sup> This book was written in the summer of 1917; hence certain anachronisms.

head, he will at least be provided for." He did not understand the significance of the introspective, brooding silence, that tenacious regard for his honor, that willingness to undertake hazardous enterprises without claiming any material reward, which Horatio Nelson had already shown and continued to show to the day of his death. We must test the hypothesis that the special gifts required for a naval fighter are foreshadowed in the child; for, if this prove to be correct, the principle should be utilized in making selection of untried officers.

The "special gift" is, as its name implies, something that has come, willynilly, through the germ plasm. Such hereditary traits are usually *family* traits and recur again and again in the family. We have, therefore, to note the indications of a special gift in the boy by an examination of the family, to see where that gift has been developed elsewhere. In the case of a few traits we know rather exactly the relationship that two or more persons in successive generations showing a "gift" may be expected to bear to each other. Such knowledge will be a useful check on the indications of juvenile promise.

## 2. SPECIAL PROCEDURE.

To get at the requisite facts for the present investigation into the juvenile promise shown by great naval commanders, and hereditary factors present in their families, the reading of a considerable number of biographies of naval men was undertaken. In some instances, as notably in the case of Nelson, several distinct "lives" were read; in most cases only one. In the case of British officers the Encyclopædia Britannica was found of assistance; in the case of American officers, the National Cyclo-pædia of American Biography was used (with caution); also the American "Who's Who." For family histories research was made in the genealogical libraries of Greater New York, and for British families Burke's "Peerage and Landed Gentry" and other like official genealogies were found very useful. In all this work I had the assistance of my wife, Gertrude C. Davenport, and especially of my assistant, Miss Mary T. Scudder, who did most of the tracing of genealogies and arranged the pedigree charts. This work would hardly have been possible except for an arrangement with the Brooklyn Public Library, which generously mailed to us all the books that we desired from its extensive collections. The compilation of the facts has taken six or eight months of steady work.

In regard to the method of selection of officers. First of all, this was determined by the availability of full biographies. There are some naval officers quite as eminent as those included in our list about whom we could get few pertinent data. Many biographies gave little information about juvenile promise or family history and these could not be used. No selection, it need hardly be said, was made with the aim of supporting any preformed conclusions. Practically all the information that we gathered that would throw light on our problem has been set forth, nearly or exactly, in the words of the biographer. We have been always alive to the error introduced by substituting for the descriptive terms of the author terms of our own which could hardly avoid being

somewhat "colored" by our prepossessions. Naturally in the "Tables" it often becomes necessary to place individuals into certain categories not named by the biographer. For the full data that justify this assignment the reader must consult the work or works cited at the ends of the biographies in Part II. In a word, we have tried to approach this subject in the inductive spirit and to draw only such conclusions as the facts seem to warrant. How far the attempt has been successful each reader, being in possession of all of the facts, may judge for himself.

### III. RESULTS OF STUDY.

#### 1. TYPES OF NAVAL OFFICERS.

Successful naval officers are of various types. This is because, as Mahan (1901, p. 151) says: "Each man has his special gift, and to succeed must act in accordance with it." It is also true that different kinds of gifts can be utilized to advantage in the navy; for the navy needs not only fighters and tacticians, but also strategists, administrators, diplomats, explorers, and surveyors. It can make use of inventors, constructors, teachers, and writers. Indeed, especially in times of peace, advancement is made chiefly by seniority, and a naval officer may reach highest rank merely by longevity. The term "naval officers" consequently corresponds to a single trait no more than "officer," but a larger proportion of naval officers have a common trait than the group of "officers." The three commonest traits are: (1) love of sea; (2) capacity for fighting; (3) capacity for commanding or administering. One person may combine in himself all these three and even other important traits; so in studying a trait at a time we may consider an individual more than once. For example, Nelson was a great strategist and a great tactician, and had the traits that make a man a brilliant, gallant fighter.

#### 2. TEMPERAMENT IN RELATION TO TYPE.

Temperament is the general quality of response shown by a person. Three principal kinds of temperament are recognized, and they are subdivided and combined in various ways. We may reckon the temperaments as overactive, *hyperkinetic*; underactive, *hypokinetic*, and intermediate or normal. The hyperkinetic temperaments are the choleric and the nervous (or sanguine). The hypokinetic temperaments are the phlegmatic and the melancholic. The intermediates are prevailingly calm and cheerful. "The *nervous* person is active, irritable, excitable, ambitious, given to planning, optimistic, usually talkative and jolly. The *choleric* person is overactive, starts on new lines of work before completing the old, brags, is usually hilarious, hypererotic, often profane, liable to fits of anger, destructive, assaultative, and even homicidal." "The *phlegmatic* temperament is characterized by quietness, seriousness, conservativeness, pessimism. The person of *melancholic* temperament is unresponsive (often mute), lachrymose, given to worry, weak and incapable, feels life a burden, often longs for death as a relief." The possessor of the *intermediate* or *normal* mood "works and plays moderately, laughs quietly, does

not weep easily, feels little drive, and on the other hand is always responsive and coöperative." (Davenport, 1915.) The hyperkinetic and hypokinetic moods may alternate with each other and with the normal mood.

Table 1 shows the relation between temperament and the type of naval officer. Our best judgment was used in assigning the categories, and the assignment to type and temperament was made as independently as possible in each case. It appears that most naval officers who were primarily fighters were of the hyperkinetic type; although one is with some hesitation classified as hypokinetic. On the other hand the great strategists and even the tacticians and most of those whose chief service was in administration are hypokinetics or intermediates. Nelson stands alone in combining great strategic insight, tactical skill, and fighting gallantry of the first order, and this he was able to do because of the combination in him of hyperkinesis and hypokinesis. John Paul Jones had a similar mixed temperament but not the strategic insight. There are, however, many details in the career of Paul Jones and Nelson that bear a remarkable resemblance.

TABLE 1. — *Temperament in Relation to Type.*

<i>Strategic-tactic-combative gifts</i>	
<i>Hyperkinetic-hypokinetic:</i> Nelson — 1	
<i>Combative gift</i>	
<i>Hyperkinetic (nervous or romantic):</i> Bainbridge, Barney, Barry, R. Blake, Farragut, Hoste, Keppel, Lawrence, MacDonough, Morris, O'Brien, Pellew, Perkins, O. H. Perry, D. Porter, D. D. Porter, Stockton, Tromp, Beresford, Dewey, Smith, Decatur, Foote — 23	
<i>Intermediate:</i> Blake, Elphinstone (Keith) — 2	
<i>Hypokinetic (phlegmatic or classic):</i> Walseley — 1	
<i>Combative and adventurous gifts</i>	
<i>Hyperkinetic-hypokinetic:</i> John Paul Jones — 1	
<i>Hyperkinetic (nervous or romantic):</i> Cochrane, Cushing, Maffitt, Raleigh — 4	
<i>Tactic gift</i>	
<i>Intermediate:</i> Saumarez — 1	
<i>Hypokinetic (phlegmatic or classic):</i> Collingwood, Howe — 2	
<i>Strategic gift</i>	
<i>Intermediate:</i> Paulding, M. C. Perry, Preble, Semmes — 4	
<i>Hypokinetic (phlegmatic or classic):</i> Mahan, Hardy — 2	
<i>Diplomatic gift</i>	
<i>Intermediate:</i> Tattnell — 1	
<i>Administrative gift</i>	
<i>Hyperkinetic (nervous or romantic):</i> Jervis (?), Philip, Rodgers (?) — 3	
<i>Intermediate:</i> Blake, Hopkins, Hornby, Markham, Moresby, W. H. Parker, Sands, Seymour, Tucker, Winslow, Rodney — 11	
<i>Hypokinetic (phlegmatic or classic):</i> Beaver, Brenton, Phillip — 3	
<i>Adventurous-literary gifts</i>	
<i>Intermediate:</i> Marryat — 1	
<i>Thalassophilic gift</i>	
<i>Intermediate:</i> Brown, Hawkins — 2	
<i>Explorative gift</i>	
<i>Intermediate:</i> Flinders, Franklin — 2	
<i>Hypokinetic:</i> McClintock — 1	
<i>Constructive gift</i>	
<i>Intermediate:</i> Buchanan — 1	
<i>Incentive gift</i>	
<i>Hyperkinetic:</i> Dahlgren — 1	
<i>Intermediate:</i> R. Jones — 1	



The practical conclusion is drawn that to select a future great fighting man it is almost essential that he should be of a prevalingly hyperkinetic temperament.

### 3. JUVENILE PROMISE OF NAVAL OFFICERS OF THE VARIOUS TYPES.

#### FIGHTERS.

To this class we assign 31 as typical. These are: 1, Bainbridge; 2, Barney; 3, Barry; 5, Beresford; 7, R. Blake; 11, Cochrane; 13, Cushing; 15, Decatur; 16, Dewey; 17, Duncan; 18, Elphinstone (Lord Keith); 19, Farragut; 21, Foote; 29, Hoste; 33, John Paul Jones; 34, Keppel; 35, Lawrence; 36, Macdonough; 43, Morris; 44, Nelson; 45, O'Brien; 48, Pellew; 49, Perkins; 50, O. H. Perry; 53, David Porter and D. D. Porter; 59, Saumarez; 62, W. Sidney Smith; 63, Robert F. Stockton; 65, Tromp; 68, Wolseley. Of these 31 persons I was able to get no juvenile history in the case of Nos. 3, 7, 34, and 43. Of the remaining 27 we have the following behavior recorded:

TABLE 2.

- |   |   |
|---|---|
| 1. <i>Bainbridge</i> : Early love of sea; sailor at 15; fond of risky, boyish undertakings. | 44. <i>Nelson</i> : Desire to go to sea; love of adventure for adventure's sake; honorable.                               |
| 2. <i>Barney</i> : Nomadism, fearlessness of responsibility; intrepidity, quick temper.     | 45. <i>O'Brien</i> : Love of the sea.   |
| 5. <i>Beresford</i> : Adventurous, full of pranks and practical jokes.                      | 48. <i>Pellew</i> : Love of sea and of adventure; fearlessness.   |
| 11. <i>Cochrane</i> : Nomadic.  | 49. <i>Perkins</i> : Fearlessness and adventurousness; poor student.  |
| 13. <i>Cushing</i> : Love of adventure; poor and unmanageable student in Naval Academy.     | 50. <i>O. H. Perry</i> : Fearless, adventurous, choleric, studious, had intellectual curiosity; was midshipman at 14.     |
| 15. <i>Decatur</i> : Love of sea; fiery nature.   | 53. <i>Porter</i> : Nomadic, impulsive, belligerent, pertinacious, courageous.  |
| 16. <i>Dewey</i> : Love of adventure and quickness of response.                             | 53. <i>D. D. Porter</i> : Love of sea and adventure.  |
| 17. <i>Duncan</i> : Nomadic.  | 59. <i>Saumarez</i> : Had a taste for the navy.   |
| 18. <i>Elphinstone</i> : Love of sea (at 15 years).   | 62. <i>Smith</i> : Nomadic.   |
| 19. <i>Farragut</i> : Love of sea and adventure.  | 63. <i>Stockton</i> : Ambitious, scholarly; champion of the weak, fought the strong.                                      |
| 21. <i>Foote</i> : Love of sea; adventurousness, jollity, poor scholarship.                 | 65. <i>Tromp</i> : At sea when 9 years old; when his father was killed the lad called on the marines to avenge his death. |
| 29. <i>Hoste</i> : Ever restless and buoyant; love of hunting and fishing.                  | 68. <i>Wolseley</i> : Nomadic.  |
| 33. <i>Jones</i> : Nomadic, active, independent.  |   |
| 35. <i>Lawrence</i> : Longing for the sea.  |   |
| 36. <i>Macdonough</i> : Fondness for adventure and practical jokes.                         |   |

In the above table either an early taste for the sea or "nomadism" is mentioned 19 times, also going to sea at 9 and 14 years respectively in 2 cases. Here, too, should doubtless be included 5 cases of adventurousness, making a total of 26 cases (out of the 27 recorded) who are early fond of the sea, nomadic, restless, and fond of adventure. Of the remaining case, Stockton, it is stated that as a boy he showed personal courage, was champion of the weak, won victories over the strong. Also he was early fired with an ambition to excel Nelson; and he entered the navy at the outbreak of the War of 1812 at the age of 17 years. It is probable that Stockton is like the other 26, and we may conclude that great naval *fighters*

are nomadic or "fond of the sea" or adventurous or belligerent in their childhood and youth. Contrariwise, it is not probable that a boy who does not show these traits will become a great naval fighting officer.

STRATEGISTS.

The successful strategist is one who plans successful campaigns, can foresee the enemy's probable plans, and can take the appropriate steps to block them and start a series of offensive operations that shall bring the war to a close. Great strategists are relatively few. Those placed in this category in the present study are as follows: 44, Nelson; 31, Jervis (Lord St. Vincent); 38, Mahan; 47, Paulding; 50, Matthew C. Perry; 54, Preble; 56, Rodgers; 60, Semmes; 24, Hardy. We have no data about the juvenile reactions of No. 38. Of the remaining 8 the following behavior is recorded.

TABLE 3.—*Juvenile Reactions of Naval Strategists.*

24. <i>Hardy</i> : Loved the sea and adventure.	54. <i>Preble</i> : Ran away to sea; fond of hunting and adventure.
31. <i>Jervis</i> : Fond of sea, energetic.	56. <i>Rodgers</i> : Ran away to sea at 13; fearless of responsibility.
44. <i>Nelson</i> : Love of adventure for adventure's sake; honorable.	60. <i>Semmes</i> : Nomadic.
47. <i>Paulding</i> : Desirous of adventure.	
50. <i>M. C. Perry</i> : Fond of adventure, fearless.	

Thus of these 8 strategic naval officers every case showed as a boy a fondness of adventure or of the sea. Two ran away early to go to sea. They had not merely certain desires, but knew how to secure the realization of those desires. They early show, on the whole, greater intelligence than the fighters.

ADMINISTRATORS.

Of the men whose success in the navy was primarily administrative, some were good strategists, but they were chiefly noteworthy for organization and the maintenance of discipline; or for administrative work on land. Every navy has need of some of these, especially in time of peace. The English navy develops a great many of them. To this group are assigned 18 naval officers, namely: 4, Beaver; 5, Beresford; 6, G. S. Blake; 8, Brenton; 28, Hornby; 30, Howe; 31, Jervis; 39, Markham; 42, Moresby; 46, W. H. Parker; 51, J. W. Philip; 52, Arthur Phillip; 56, Rodgers; 57, Rodney; 58, Sands; 61, Seymour; 66, Tucker; 67, Winslow.

The juvenile traits of 14 of these are more or less fully recorded in table 4:

TABLE 4.—*Juvenile Reactions of Naval Administrators.*

4. <i>Beaver</i> : Nomadism; scholarship.	46. <i>W. H. Parker</i> : Fond of adventure and fun.
5. <i>Beresford</i> : Full of pranks and practical jokes; an adventurous sportsman.	51. <i>J. W. Philip</i> : Nomadism; fondness for pranks; good humor.
6. <i>Geo. Smith Blake</i> : Fearlessness of responsibility.	56. <i>Rodgers</i> : Fearlessness of responsibility; ran away at 13 to see ships.
8. <i>Brenton</i> : Nomadism.	57. <i>Rodney</i> : Went to sea at 13 years.
28. <i>Hornby</i> : Nomadism; fondness for hunting, fishing, etc.	61. <i>Seymour</i> : Fondness for sea.
31. <i>Jervis</i> : Fondness of sea; great energy.	66. <i>Tucker</i> : Longing for the sea.
42. <i>Moresby</i> : Fondness for sea.	67. <i>Winslow</i> : Fondness for adventure and sea.

Of the foregoing 14 persons, nomadism or fondness for the sea is found in 11. Love of adventure is found in 3; fearlessness of responsibility is specially mentioned in 3, and fondness for fishing, hunting, etc., in 3 others. Three of them show love of fun or pranks. There is no case of quarrelsomeness or pugnacity. This group shows less pugnacity in boyhood than the future fighters; at least 2 of them showed an early willingness to assume responsibility.

#### EXPLORERS.

Of exploring naval officers the most noteworthy on our list are: 16, Matthew Flinders; 18, John Franklin; 34, McClintock; 35, Moresby. Flinders was nomadic in his youth, had a strong desire to go to sea, and was a good student. Franklin had early a love of discovery and adventure and a great native curiosity; McClintock was a great walker and had considerable mechanical ability and Moresby was fond of the sea. These 4 were all early nomads and showed a love of travel. A juvenile love of discovery and curiosity is to be expected in the youth of a future explorer.

#### ADVENTURERS.

Of adventurous naval officers the most striking on our list are: 11, Cochrane; 13, Cushing; 33, John Paul Jones; 37, Maffitt; 40, Marryat. To these may be added William De Rohan, brother of No. 14 (Dahlgren). Cochrane was nomadic in his youth; Cushing, adventurous and a poor student; Maffitt, a lover of adventure and fearless; and Marryat, nomadic and adventurous. Of the early history of De Rohan we have no record. The strikingly adventurous naval officers were especially adventurous in their youth.

#### CONCLUSION AS TO JUVENILE PROMISE.

The conclusion that may be drawn from this study is that in their youth future successful naval officers show love of travel or of the sea. In addition, they frequently show adventurousness if they are to be great fighters; may actually run away from home if they are to be future strategists; may be especially good-natured, if they are to be successful administrators; are apt to show a juvenile love of travel or an interest in scientific matters if they are to be future explorers.

Examples of juvenile promise outside of our series of 68 naval officers are common. I cite two from the history of Dutch admirals.

Michael Adrianszoon de Ruyter (b. 1607, at Flushing), when 10 or 12 years old, climbed the church steeple and sat on the ball at its top and waved to the people below. Workmen had meantime taken away the ladder by which he had ascended, and when he was ready to come down he kicked away the slates and made a foothold on the slats to which they were fastened. He was regarded as the naughtiest boy in Flushing, despite his father's thrashings. He did not study well at school, but played tricks

upon the masters. Put to work in a rope-yard, he shortly organized the boys into a company to fight the boys of another part of the town. He did not stick to his work and became more and more unmanageable. "Always at the waterside, or in boats, or up the mast of some ship, or going about with young sailors just returned from a long voyage, to whose yarns he listened with eagerness, he no sooner got to his wheel or in the rope-yard than he showed signs of laziness and unwillingness to act the drudge." (De Liefde, 17: 152-3.) Sent out as boatswain's boy in 1618, "He seemed to have left all of his vices ashore with his old clothes." He was without fear. Made a prisoner in Spain by pirates, he walked all the way home. He became very fond of mathematics and map-making. Many of his maps are still in use.

Witte Cornelis de Witt did so much mischief at school when he was 11 years of age that his mother lectured him and made him promise that, as a Baptist, he would not fight again. The boys jeered him when they heard of his promise, so he quietly joined the Lutherans in order to be free to fight as much as he wanted to. He now tried all sorts of trades, but everywhere fought the other apprentices and lost his jobs. He hated the trades, anyway. At 17 years he went as a cabin boy in an East Indian merchantman bound for Java. He became a harsh, cruel, jealous, overbearing man, but a great fighter. He was engaged in 50 sea fights and commanded in 15 great battles. He could not curb his temper. His body was covered with wounds. He died poor and without friends. It is said:

"At the age of 17 he entered the navy, and even then his smartness and activity, his feats of daring and his spirit of resolute independence awakened remark and pointed him out as one specially fitted to distinguish himself in his profession." (Encyclop. Britt. X, 73.)

#### 4. THE HEREDITARY TRAITS OF NAVAL OFFICERS.

The performance of any man depends to a large degree upon his inherent, inheritable traits; for behavior is reaction to stimulus, and the nature of the reaction is determined in part by the nature of the reacting nervous machinery. The nature of this nervous machinery depends upon hereditary factors of whose development the course is influenced by environment. Thus heredity and environment are closely interwoven in determining the history of a man's performance, as Mahan so clearly states in the words quoted (page 4). Since heredity is so potent in determining the product, and particularly the vocation which a man selects and in which presumably he is more or less successful, it is worth while to consider the occupations of close relatives of the propositus (table 5). Since for our purpose it is desirable to consider less the administrative than the belligerent naval officers, especial emphasis is laid upon the occurrence of vocations related to that of the naval fighter.

TABLE 5.

	Naval officer.	Country.	Type.	Temperament.	Juvenile promise.	Consort.
1	W. Bainbridge.	U. S.	Fighting. ....	Hyperkinetic.	Love of sea early, sailor at 15, fond of risky boyish undertakings.	.....
2	J. Barney. ....	U. S.	Fighting. ....	Hyperkinetic.	Nomadism, fearlessness of responsibility, intrepidity, quick temper.	.....
3	J. Barry. ....	U. S.	Fighting. ....	Hyperkinetic.	.....	.....
4	P. Beaver. ....	Eng.	Administrator.	Hypokinetic.	Nomadism, scholarship.	.....
5	C. Beresford. ...	Eng.	Fighter, administrator.	Hyperkinetic.	Full of pranks and practical jokes, adventurous sportsman.	.....
6	G. S. Blake. ...	U. S.	Administrator.	Intermediate.	Fearless of responsibility.	Daughter of Commodore James Barrow
7	R. Blake. ....	Eng.	Fighter. ....	Intermediate.	.....	.....
8	J. Brenton. ...	Eng.	Administrator.	Hypokinetic.	Nomadism. ....	A distant cousin.
9	M. Brown. ...	U. S.	Sailor. ....	Intermediate.	.....	A Coffin, Newburyport
10	F. Buchanan. .	U. S.	Constructor. ...	Intermediate.	.....	Daughter of governor of Maryland.
11	T. Cochrane. ...	Eng.	Adventurer, fighter, inventor	Hyperkinetic.	Nomadic. ....	.....
12	C. Collingwood.	Eng.	Tactician. ....	Hypokinetic.	Good student, mld, showed no talents, reserved, longing for sea.	.....
13	W. B. Cushing.	U. S.	Adventurous, fighter.	Hyperkinetic.	Poor and disturbing student in Naval Academy, love of adventure.	.....
14	J. A. Dahlgren.	U. S.	Inventor. ....	.....	Desire for navy and sea, good at mathematics, active.	Daughter of merchant.

TYPES OF NAVAL OFFICERS.

TABLE 5—Continued.

Children.	Sibs.	F.	F's brothers.	M. F.	M's brothers.	
Lawyer, died young.	.....	Physician. ...	.....	Wealthy citizen.	.....	1
6 sons: 1 a naval officer, 1 member of Congress.	1 brother, unknown; 1 brother temporarily a marine officer; kept a hotel.	Farmer.....	No brother	.....	.....	2
.....	.....	.....	.....	.....	.....	3
.....	1 brother, major; 1 clergyman.	Clergyman. ...	.....	Clergyman. .	.....	4
.....	All 5 sportsmen, 1 dare-devil cowboy, 1 soldier (galant), 1 had charge of king's race-horses.	Clergyman. ...	1 killed at hunting.	.....	.....	5
Son, naval fighter in Civil War, lieutenant commander.	1 bro. grad. Harvard; d. at 18 yrs; 1 bro.	Lawyer. ....	1 surgeon in navy.	.....	.....	6
.....	2 naval, 1 sea captain, 1 merchant, 1 in army, 1 lawyer, 1 banker.	Merchant, sailor.	.....	Wealthy. ...	.....	7
1 son died young, wished to become a naval commander; 1 landsman.	1 capt. in navy and reformer; 1 killed as lieutenant in navy.	Officer in Colonial navy.	.....	.....	.....	8
2 sea captains, 1 cooper on ship-board.	1 followed sea as cooper; 1 unknown.	Infantry capt. in French war.	.....	.....	.....	9
1 rice broker, 1 daughter had naval son.	1 naval paymaster; 1 farmer.	Physician.....	.....	T. McKean, signer of Declaration, fighter.	.....	10
.....	.....	Hyperkinetic, inventive.	1 colonel in army.	.....	.....	11
None. ....	1 captain in navy.	Merchant.....	.....	.....	.....	12
.....	1 navy paymaster, 2 army officers, killed in battle.	Physician.....	.....	.....	1 lost at sea. All of sister's sons, naval officers.	13
1 naval officer and engineer, 1 army artillery officer killed in battle, 1 army officer.	1 naval fighter of fortune.	Traveler and merchant.	1 naval surgeon.	Soldier.....	.....	14



TABLE 5 — *Continued.*

	Naval officer.	Country.	Type.	Temperament.	Juvenile promise.	Consort.
15	S. Decatur. . . .	U. S.	Fighter . . . . .	Hyperkinetic.	Love of sea, fiery nature.	. . . . .
16	Geo. Dewey. . . .	U. S.	Fighter, tactician.	Intermediate hyperkinetic.	Love of adventure, quickness in response.	. . . . .
17	A. Duncan. . . . .	Eng.	Fighter . . . . .	. . . . .	Nomadic. . . . .	Half sister of general and governor.
18	G. Elphinstone.	Eng.	Fighter . . . . .	Hypokinetic.	Love of sea (at 15 years).	. . . . .
19	D. G. Farragut.	U. S.	Fighter . . . . .	Hyperkinetic.	Loved sea and adventure.	. . . . .
20	M. Flinders. . . .	Eng.	Explorer . . . . .	Slightly hyperkinetic.	Good student, navy at 15, nomad, loved discovery, call of sea strong.	. . . . .
21	A. H. Foote. . . .	U. S.	Fighting . . . . .	Hyperkinetic.	Adventuresome, jolly, love of sea.	2d cousin.
22	E. Fox. . . . .	U. S.	Nomadic. . . . .	. . . . .	Nomadic, love of sea.	. . . . .
23	J. Franklin . . . .	Eng.	Explorer . . . . .	Intermediate.	Curiosity, love of discovery and adventure.	. . . . .
24	T. M. Hardy . . . .	Eng.	Strategist . . . . .	Hypokinetic.	Love of sea and adventure.	. . . . .
25	E. Hawke . . . . .	Eng.	Fighting, tactician.	Calm. . . . .	. . . . .	. . . . .
26	J. Hawkins . . . .	Eng.	Sea-rover. . . . .	Intermediate.	. . . . .	Daughter treasurer navy.
27	E. Hopkins . . . .	U. S.	Political, sea-loving.	Intermediate.	. . . . .	Daughter shipmaster.

TABLE 5 — Continued.

Children.	Sibs.	F.	F's brothers.	M. F.	M's brothers.	
.....	1 fighter .....	Sea captain and captain in navy.	.....	Irish gentleman.	.....	15
Traveling salesman.	1 in life insurance business.	Hyperkinetic, physician.	.....	.....	.....	16
My captain in navy, Alex. lieutenant of infantry.	1 colonel in army, 1 in East India Co.	.....	.....	.....	.....	17
.....	1 in navy and East India Co., John in army and lieutenant governor, George in navy.	.....	.....	.....	Frank, soldier of fortune; George, soldier and diplomat.	18
Ageous .....	William in navy, George drowned at 10 years.	Adventurous and daring, sailor, explorer, soldier, charge of gunboat.	.....	Kentucky pioneer.	.....	19
Fighter's son, Flinders Pele leading ar- chologist.	1 lieutenant in royal navy.	Surgeon .....	.....	.....	.....	20
Government boy. 1 other	1 brother, jolly ...	West India merchant, senator, governor.	.....	General merchant in West India trade.	None .....	21
.....	.....	Tailor .....	.....	.....	.....	22
.....	1 in army and interested in science, F. R. S., 1 judge at Madras.	Banker .....	.....	.....	.....	23
.....	.....	.....	.....	.....	.....	24
.....	.....	Barrister .....	.....	Barrister ...	Commissioner of trade and plantations, in Parliament.	25
Lord, vice admiral and knight.		Sea captain and naval officer.	.....	.....	.....	26
B., captain in navy, fighter.	Stephen, a statesman (signer of Declaration of Independence), John and Samuel sea captains.	Farmer .....	.....	Surveyor ...	Surveyor .....	27

TABLE 5—Continued.

	Naval officer.	Country.	Type.	Temperament.	Juvenile promise.	Consort.
28	G. P. Hornby.	Eng.	Diplomatist, administrator.	Calm . . . . .	Nomadic, fond of hunting, fishing, etc.	. . . . .
29	W. Hoste. . . . .	Eng.	Fighter. . . . .	Hyperkinetic.	Ever restless and buoyant, liked to hunt and fish.	. . . . .
30	Richard Howe.	Eng.	Tactician and administrator.	Hypokinetic.	. . . . .	. . . . .
31	J. Jervis. . . . .	Eng.	Strategist, administrator.	Hyperkinetic.	Fond of sea; energetic.	. . . . .
32	Catesby Jones.	U. S.	Inventive. . . . .	Intermediate.	. . . . .	. . . . .
33	J. P. Jones. . . . .	U. S.	Naval fighter of fortune.	Hyperkinetic-hypokinetic.	Nomadic, independent, active.	. . . . .
34	H. Keppel. . . . .	Eng.	Fighter. . . . .	Hyperkinetic.	. . . . .	. . . . .
35	J. Lawrence. . . . .	U. S.	Fighter. . . . .	Hyperkinetic.	Longed to go to sea.	. . . . .
36	T. Maodonough.	U. S.	Fighter. . . . .	. . . . .	Fond of adventure and practical jokes.	. . . . .
37	J. N. Maffitt. . . . .	U. S.	Adventurous. . . . .	Hyperkinetic.	Love of adventure, absence of fear.	. . . . .
38	A. Mahan . . . . .	U. S.	Strategist. . . . .	Hypokinetic.	. . . . .	. . . . .
39	J. Markham . . . . .	Eng.	Administrator.	Intermediate.	. . . . .	. . . . .
40	F. Marryat . . . . .	Eng.	Adventurous, literary.	Intermediate.	Nomadic, adventurous.	. . . . .

TABLE 5 — Continued.

	Naval officer.	Country.	Type.	Temperament.	Juvenile promise.	Consort.
41	F. McClintock.	Eng.	Exploring ....	Hypokinetic.	Great walker, mechanical.	.....
42	F. Moresby. ...	Eng.	Administrative, exploring....	Intermediate.	Fond of sea. ....	.....
43	C. Morris. ...	U. S.	Fighting. ....	Hyperkinetic.	.....	.....
44	H. Nelson. ...	Eng.	Strategic, tactical and fighting.	Hyperkinetic, hypokinetic.	Love of adventure for adventure's sake; honorable.	Wilful.
45	J. O'Brien. ...	U. S.	Fighting. ....	Hyperkinetic.	Love of sea. ....	.....
46	W. H. Parker.	U. S.	Administrator..	Intermediate.	Fond of adventure and fun.	.....
47	H. Paulding. ...	U. S.	Diplomatist, strategist.	Intermediate.	Desire for adventure.	.....
48	E. Fellow. ....	Eng.	Dashing fighter	Hyperkinetic.	Fearlessness, love of sea and of adventure.	.....
49	G. H. Perkins.	U. S.	Fighter. ....	Hyperkinetic.	Fearless and adventuresome; poor student.	.....
50	M. C. Perry. ...	U. S.	Strategist. ...	Intermediate.	Loved adventure; fearless.	.....
51	J. W. Philip. ...	U. S.	Administrator.	Hyperkinetic.	Full of pranks and good humor, nomadic.	.....
52	A. Phillip. ....	Eng.	Administrator.	Hypokinetic.	.....	.....
53	D. D. Porter. ...	U. S.	Fighting. ....	Hyperkinetic.	Nomadic, impulsive, belligerent, pertinacious.	Dau. of a moderate; sib of head Coast Sur
54	E. Preble. ....	U. S.	Strategist. ...	Intermediate.	Love of hunting and adventure; ran away to sea.	Dau. of a navigator.

TABLE 5 — Continued.

Children.	Sibs.	F.	F's brothers.	M. F.	M's brothers.	
2 in army, 1 in navy.	1 lieut. colonel in army.	Custom-house official, 1 member 3d Dragoons.	.....	Archdeacon of Waterford.	.....	41
Nomadic, adventurous, explorer.	.....	.....	.....	.....	.....	42
2 were soldiers, 1 a sailor.	1 lieut. in navy, capt. of artillery army, 1 lieut. in army.	In Rev. war sea captain.	.....	.....	.....	43
1 daughter, wilful..	2 clergymen, 1 clerk, 1 indolent died young.	Clergyman...	Clergyman.	Clergyman..	Naval capt...	44
Son a sailor [brother's son's son a reformer and statesman.]	5 set out on a sloop to capture a war vessel.	In Colonial militia.	.....	.....	.....	45
.....	1 commodore U.S. N.; 1 master in U. S. Volunteer navy, 1 colonel of infantry.	Commodore U. S. navy.	.....	Gen. Robert Bogardus in War of 1812.	.....	46
1 son (out of 4) became col. of cavalry.	1 naval officer.....	Major of militia, captured Maj. André.	.....	.....	.....	47
2 clergymen, 2 naval officers.	1 admiral .....	Commander of a packet at Dover.	.....	.....	.....	48
None .....	.....	Judge of probate.	.....	M M F capt. in Rev. War.	Sea captain.	49
.....	<i>Oliver Hazard Perry; James A. Perry, sword from Congress for part in naval battle; 2 other naval officers.</i>	Naval captain, audacious.	.....	Hyperkinetic stock.	.....	50
1 naval service....	.....	Practiced medicine.	.....	Professor of surgery Vt. Med. Coll.	.....	51
None.....	.....	Teacher of languages.	.....	.....	.....	52
3 sons in navy....	3 in navy.....	F sea-fighter, FF bred to the sea.	John a naval commander.	In Continental Army.	Something of "fire eater."	53
1 nomadic.....	2 marine traders, 1 merchant.	Sailing master and brig. gen.	.....	Ashipmaster.	.....	54

TABLE 5 — *Continued.*

	Naval officer.	Country	Type	Temperament	Juvenile promise	Consort
55	W. Raleigh...	Eng.	Fighter, administrator, nomad.	Hyperkinetic.	Love of adventure and fighting.	Alady of Queen Elizabeth's Court.
56	J. Rodgers...	U. S.	Strategist and administrator.	Hyperkinetic.	Ran away at 13 to see ships; fearless of responsibility.	.....
57	G. B. Rodney.	Eng.	Administrator.	Intermediate.	Went to sea at 13 yrs.	.....
58	J. R. Sands...	U. S.	Administrator.	Intermediate.	.....	.....
59	J. Saumares...	Eng.	Tactician.....	Intermediate.	Taste for navy.....	.....
60	R. Semmes...	U. S.	Strategist...	Intermediate.	Nomadic.....	.....
61	E. H. Seymour.	Eng.	Administrator.	Intermediate.	Love of sea.....	.....
62	W. S. Smith...	Eng.	Fighter.....	Hyperkinetic.	Nomadic.....	.....
63	R. F. Stockton.	U. S.	Dashing fighter (frigate type).	Hyperkinetic.	Scholarship, ambition; courage, pugnacity.	.....
64	J. Tattall...	U. S.	Diplomatic..	Intermediate.	Love of sea and of adventure. Scholarship high.	.....
65	M. H. Tromp.	Dutch	Tactician and fighter.	Hyperkinetic.	At sea when nine years old; when his father was killed he called on marines to avenge his death.	.....
66	J. R. Tucker..	U. S.	Administrator.	Intermediate.	Longing for the sea..	.....
67	J. A. Winslow.	U. S.	Administrator.	Intermediate.	Went to sea at 10 yrs. in a "ship's boat."	Cousin ...
68	W. Wolseley..	Eng.	Fighter.....	Hypokinetic.	Nomadic.....	.....



TABLE 5 — *Continued.*

children.	Sibs.	F.	F's brothers.	M. F.	M's brother.	
n navy; died iana.	Half brothers: Sir Humphrey Gil- bert, navigator and explorer; Sir John Gilbert, de- puty vice admiral.	A country gen- tleman.	.....	M M F: a great soldier.	Vice admiral of the West; interested in making plantations in Ireland.	55
ine officers, 1 of militia.	George, commodore U. S. N.	Officer in Rev. war.	.....	.....	.....	56
.....	.....	Commander of the Royal Yacht.	.....	.....	.....	57
.....	.....	Wealthy mer- chant.	.....	Surgeon in British Army.	.....	58
ryman, 1 col- in army.	1 lieutenant in army; 1 general in army; 1 surgeon.	.....	2 capt. in navy.	.....	.....	59
l captain....	2 in law.....	.....	.....	.....	.....	60
.....	.....	.....	Vice ad- miral.	.....	.....	61
.....	.....	Army officer, hyperkinetic.	A general in the army.	.....	.....	62
ura.....	1 lawyer, 1 lieutenant in army.	Lawyer.....	.....	.....	.....	63
.....	.....	Colonel and governor of Georgia.	.....	Of a distin- guished family.	.....	64
ame rear- ral in Dutch	.....	Naval captain.	.....	.....	.....	65
.....	.....	Immigrated to U. S. from Bermuda.	.....	Physician...	.....	66
al officers....	.....	Commercial ..	.....	Chairman of committee of safety.	.....	67
.....	.....	W. N. Wols- ley, captain in infantry.	.....	Gov. gen. of Nova Scotia.	1 captain in army, 1 commanded in navy.	68

TABLE 6. — *Fighting naval officers and the allied vocations of their close relations.*

44. **HORATIO NELSON.** Preëminent strategist, tactician, and fighter; hero of the Nile, Copenhagen, and Trafalgar.  
*Maternal side:* Mother: a woman "of some force of character." Mother's brother, captain in the navy and comptroller in the naval board. The mother's mother's mother's brother, Sir Robert Walpole, prime minister of England; also his brother Galfridus Walpole, of the navy, a fighter.  
*Paternal side:* The only distinguished ones were clergymen.  
*Comment:* Nelson's strategic insight may be an inheritance from both sides; a nomadic tendency may be in his mother's brother (Captain Suckling). His hyperkinetic reaction is possibly a new mutation.
11. **COCHRANE.** Naval commander, wherever fortune led him.  
*Maternal side:* Mother's father, a captain of the Royal Navy.  
*Paternal side:* Father, enlisted in army; transferred to navy and became an acting lieutenant; grew weary of this and turned toward natural science; a speculator in scientific matters and an inventor. Father's brothers: Charles, a colonel in the British army, killed at Yorktown; Alexander, a distinguished admiral of the blue; Andrew, a colonel in the army "who threw up the service in disgust and became a member of Parliament." The father of the foregoing fraternity entered the army early, but retired with the rank of major.  
*Comment:* There is perhaps inconstancy rather than pure nomadism on the paternal side, although Alexander persisted in his nomadic profession. There was probably a love of the sea in the mother's father.
13. **CUSHING.** Love of adventure.  
*Maternal side:* A brother of the mother "was lost or died at sea," presumably as a seaman of some sort. A sister of the mother, Elizabeth W. Smith, married John Pillsbury, a printer, and had a son, John Elliott, who was a graduate of the U. S. Military Academy, 1862, who served continuously in the navy until retired in 1908 and is best known for his inventions of deep-sea measuring apparatus.  
*Paternal side:* The father was Milton Cushing, who graduated in medicine; removed to Zanesville, Ohio, where he was a local merchant; then to Columbus, Ohio, and in 1837 to Wisconsin where he was appointed justice of the peace; in 1844 to Chicago and 1847 back to Ohio, where he died.  
*Comment:* On both sides there is restlessness; on the mother's side, at least, a love of the sea.
26. **HAWKINS, JOHN.** "Patriarch of the sea rovers"; brother was a ship-owner who commanded his own flotilla.  
*Maternal side:* Little known; his mother's father's father was Sir John Trelawny, warrior with King Henry at Agincourt.  
*Paternal side:* Father, one of the greatest sea captains in the west of England, an officer of the navy of Henry VIII, the first Englishman to sail into the southern seas; he made at least three voyages to Brasil.  
*Comment:* Here is evidence of adventurousness on both sides, but most marked on the paternal. The same trait reappears in the son of the propositus, who, at the age of 33 (1593), went on an expedition of exploration around South America, was made a captive, and was sent to Spain for several years; he died at the age of 62, while engaged against the Algerian pirates.
28. **HORNBY.** An able commander, nomadic and thalassophilic. One brother was captain of the Royal Engineers; another was provost of Eton College.  
*Maternal side:* His mother's father was General "Saratoga" Burgoyne, a decidedly uncontrolled sort of a man, given to gambling; also a writer of plays; a gallant army officer, who in the year 1759 introduced light cavalry into the British army. His son, Sir John Fox Burgoyne, was a great army engineer.  
*Paternal side:* Father, a naval officer of no great distinction, who was appointed to the Board of Admiralty. Father's brother became lieutenant colonel and father's father was a colonel in the army for a time and then a clergyman.  
*Comment:* The maternal side shows the greater brilliancy and restlessness; apparently love of the sea is more marked on the paternal side.

TABLE 6. — *Fighting naval officers and the allied vocations of their close relations* — Continued.

34. **KEPPEL.** A hyperkinetic naval fighter. Two of his brothers were army officers and one was for a time in the navy.  
*Maternal side:* The mother's father was a member of Parliament and acquired the title of Baron de Clifford; his son who succeeded to the title was also in Parliament. The mother's mother (Sophia Campbell) was a very intelligent, lively woman, of great personal courage. At the age of 80 years she discharged her pistols at thieves climbing over the garden wall.  
*Paternal side:* The father was "master of the horse" at court and a member of Parliament. The father's father was colonel of the King's Own regiment of dragoons and commanded the Cuban expedition sent in 1762 to reduce Havana. His brother, Augustus Keppel, became a naval commander at 22 years, negotiated a treaty with the piratical dey of Algiers, and was a brave naval fighter; in his later years he became suspicious and quarrelsome. The father's father's father was, in 1748, commander in chief of the British forces serving in the Low Countries and was later ambassador to France; his wife was the sister of Charles Lennox, from whom are descended the great Napier family of generals and admirals. Charles Lennox was grandson of Charles II, King of England.  
*Comment:* On both sides are strains of courage. The paternal side (descended from Charles II) includes more military men and Admiral Augustus Keppel.
36. **MACDONOUGH.** Adventurous and belligerent naval commander; a brother was midshipman in the navy.  
*Maternal side:* The mother's father, Samuel Vance, was a captain in the Delaware colonial militia.  
*Paternal side:* The father distinguished himself in active service as major of the Delaware battalion, 1776. In February 1777 he was elected member of the privy council and speaker of the council of Delaware, 1784, 1787. He was made second justice of the court of common pleas and orphan's court of New Castle county, Delaware.  
*Comment:* Macdonough was of belligerent blood from both sides; high intelligence and leadership is obvious in the father. His energy is probably especially from the paternal side.
40. **MARRYAT.** Adventurous, fearless, literary; of a literary fraternity.  
*Maternal side:* Mother's father, a Hessian settler in Boston, England.  
*Paternal side:* Father, parliamentarian; author of political pamphlets.  
*Comment:* If the mother's father as an immigrant was nomadic, Marryat's reaction can be easily understood. Literary taste and capacity are clearly shown in the paternal side.
45. **O'BRIEN.** Naval fighter, of a fighting fraternity.  
*Maternal side:* The mother's father was a sea captain.  
*Paternal side:* The father fought in the colonial army that took Louisburg.  
*Comment:* This family history is a fragment, but probably there is a love of the sea on the maternal side.
46. **PARKER (W. H.).** Fond of adventure, of a fraternity of fighters and administrators.  
*Maternal side:* Mother's father, a colonel of infantry (regulars) in the War of 1812.  
*Paternal side:* Father, Commodore Foxhall A. Parker.  
*Comment:* Adventurousness and belligerency probably on both sides.
47. **PAULDING.** Brave, adventurous, diplomatic.  
*Maternal side:* Mother's brother, John Ward, an officer in the Loyal America regiment during the Revolution; later settled in New Brunswick.  
*Paternal side:* Father, major of militia, one of the captors of Major John André.  
*Comment:* There is a certain loyalty and willingness to fight for ideals on the mother's side; the father also was a fighter.
49. **PERKINS.** Hyperkinetic, adventuresome, pertinacious.  
*Maternal side:* Mother's brother, a "remarkably efficient" captain. Mother's mother's father, a captain in the Revolutionary war.  
*Paternal side:* Father, studied at Harvard Law School and for 16 years presided over the probate court of Merrimac county, New Hampshire.  
*Comment:* So far as the record goes the fighters were on the maternal side only.

TABLE 6. — *Fighting naval officers and the allied vocations of their close relations* — Continued.

50. PERRY, OLIVER. Pertinacious fighter. Matthew, pertinacious diplomat and naval administrator.  
*Maternal side:* Mother's brother, served in army under Cornwallis and also commanded a merchantman; another brother served under Cornwallis. The mother's mother's father was a Wallace of the famous Scotch family of fighters.  
*Paternal Side:* Father, a sea captain who served with distinction during the Revolutionary war upon armed vessels and in 1798 became a captain in the United States navy. The father's father was chief justice of the court of common pleas and president of the town council of Kingston, Rhode Island.  
*Comment:* There are fighters and sea captains on both sides.
53. PORTER, DAVID DIXON. Nomadic and adventurous; four of his brothers died while serving in the navy as officers or midshipman; two of his sons were naval officers.  
*Maternal side:* The mother's brother is said to have been "something of a fire-eater"; the mother's father at the age of 15 joined the Continental army and served five years; he held various political offices and in 1809 was elected to Congress, retaining his seat until 1815; he was a county judge and a collector of customs.  
*Paternal side:* The father, David Porter, jr., commander of the *Essex*, was nomadic and hyperkinetic. His brother John was a commander in the navy. Their father, David senior, also was a lover of the sea and so was his father, in turn a merchant captain. One of David senior's daughter's sons was a lieutenant in the Mexican navy, killed in action. Of John's sons, one was a general and one as a midshipman was lost at sea.  
*Comment:* The Porter family is one of our most remarkable naval families. Through 5 generations without a break extends naval efficiency of a high order, through 3 generations of the highest order. The marriages, so far as known, usually tended to maintain or exaggerate the traits.
56. RODGERS, JOHN. Fearless, orderly, able to organize, fond of the sea, willing to accept responsibility. His brother George received a medal from Congress for gallantry in the navy during the War of 1812.  
*Maternal side:* The mother was a woman of "great strength of character," the daughter of a Presbyterian minister.  
*Paternal side:* The father, born in Scotland, was captain in command of a regiment of militia during the American Revolution.  
*Comment:* The origin of the fine fraternity of the Rodgers brothers remains unexplained for lack of details of earlier generations.
63. STOCKTON. Dashing, hyperkinetic, diplomat.  
*Maternal side:* Mother's father, ambassador to Austria and Russia, secretary of state for New Jersey in 1794. One mother's brother's son became a lieutenant in the navy, but later retired to a plantation in Mississippi; another became United States senator.  
*Paternal side:* Father, leader of the New Jersey bar at the age of 25 years, a presidential elector at 28, and a United States senator at 32. His only brother was United States district attorney for New Jersey. His sister, whose husband was chaplain in the navy, had a son who became a major general (David Hunter, 1802-1886) in the United States army and another who, after serving as naval surgeon through the Mexican and Civil wars, was retired with the rank of commodore.  
*Comment:* Though the nearest relatives are legal, administrative, and parliamentary, yet on each side are naval and fighting first cousins. Doubtless a hyperkinetic tendency came through the precocious father and the father's father, signer of the Declaration of Independence. The origin of Stockton's diplomatic capacity is not difficult to discover on the maternal side.
67. WINSLOW. Nomadic, fearless, energetic.  
*Maternal side:* The mother's mother's mother's father was William Rhett, the only near relative regarded as having the ambition and qualities necessary for becoming a naval warrior. One of his granddaughters married a British admiral and six of their grandchildren were naval officers, including four British admirals.  
*Paternal side:* The father was "engaged in commercial pursuits"; nothing more is known of his family.  
*Comment:* This is a striking case of nomadism carried through 4 generations of females.

TABLE 6. — *Fighting naval officers and the allied vocations of their close relations* — Continued.

16. **DEWEY.** Quick in response, fond of adventure, cool and brave in emergency. A brother was quartermaster of infantry in the Civil War and this brother's son is a naval officer.  
*Maternal side:* Little evidence of adventurousness or hyperkinesis. None of the known relatives on this side show love of the sea.  
*Paternal side:* Father, a physician, sometime army surgeon and president of an insurance company. The father's father's father was a captain of militia in the Revolution; his brother was a gunsmith with Ethan Allen at Ticonderoga. Of these brothers the mother's mother's father was George Denison, the most brilliant pioneer soldier of the Massachusetts colony, from whom also is descended Commodore John Rodgers (q. v.).  
*Comment:* In absence of fuller details about grandparents it is hard to interpret the origin of Dewey's traits. Probably the father had something of his quickness in response.
21. **FOOTE.** An excellent organizer and gallant fighter; audacious. Brother, a congressman.  
*Maternal side:* Mother's father, a brigadier general of militia.  
*Paternal side:* Father voyaged to West Indies; was a member of the United States Senate and House of Representatives; also governor of Connecticut.  
*Comment:* The fighting capacity seen in mother's side; administration in father.
25. **HAWKE.** A fighter.  
*Maternal side:* Mother's mother's father a general in the army, of the well-known fighting Fairfaxes.  
*Paternal side:* Father, a lawyer.  
*Comment:* A restlessness comes down through an exclusively female line.
54. **PREBLE.** Liable to outbreaks of temper; fond of the sea, a good disciplinarian and diplomat. Two of his brothers were captains of merchantmen.  
*Maternal side:* The mother's father was a shipmaster and merchant and held many town offices. His brother was similarly a shipmaster and merchant of much enterprise.  
*Paternal side:* The father was a sea captain, entered the army, and attained the rank of brigadier general. It is said that he was the first white man to ascend Mount Washington; he had a violent temper.  
*Comment:* The violent temper is clearly a Preble trait and the father was also fond of mountain climbing (nomadic trait). The love of the sea is a trait shown on both sides.
61. **SEYMOUR.** Thalassophilic, administrative.  
*Maternal side:* Mother's father, a member of Parliament; mother's mother's father, a member of Parliament.  
*Paternal side:* Father, a clergyman, two of whose brothers were naval officers: Michael an admiral and Edward a captain; another brother had a son who was a vice admiral. Father's father, a distinguished admiral. Father's mother's father, a captain in the Royal Navy.  
*Comment:* On the face of the pedigree chart, the maternal side brought legislative ability and the paternal side love of the sea and gallantry. Seymour combined these traits.
64. **TATTNALL.** Fearless, judicious, brilliant, beloved, diplomatic.  
*Maternal side:* Of the mother's father little is known except that the Fenwicks were a family of great influence. The mother's younger sister had a son, Christopher Gadsden, commander of the United States brig *Vixen*.  
*Paternal side:* Father's father was a Loyalist and returned to England with "Father"; the latter declined a commission in the Royal army, returned to America, and fought with the colonial troops; became a brigadier general, United States senator, and governor of Georgia.  
*Comment:* The only naval man found in this record is on the maternal side; but fighting capacity and diplomacy are found in the father.
68. **WOLSELEY.** Somewhat nomadic, hypokinetic.  
*Maternal side:* His mother's brother, Phillips Cosby, became a British admiral and another brother was captain in the army. The mother's father was a lieutenant in the army and lieutenant governor of Nova Scotia.  
*Paternal side:* The father was a captain of infantry; and his father's father was in the army in Ireland under William III and later a member of Parliament.  
*Comment:* The nearest relative with his love for the sea is his mother's brother, Admiral Cosby. Field Marshal Viscount Wolseley (born 1833) was the grandson of a second cousin.

TABLE 7. — *Summary of evidence.*

No.	Propositus.	Maternal side.	Paternal side.
44	Nelson. ....	M. B. thalassophilic, strategic, diplomatic.	Faithful.
11	Thalassophilic, nomadic. ....	M. F. thalassophilic. ...	Inconstant, nomadic.
13	Adventurous. ....	Restless. ....	Restless.
26	"Sea rover". ....	Adventurous. ....	Adventurous.
28	Thalassophilic, nomadic, able.	Brilliant, restless. ....	Thalassophilic.
34	Hyperkinetic, combative. ....	Legal, courageous. ....	Combative, nomadic (?).
36	Energetic, adventurous, combative.	Combative. ....	Combative, energetic, intelligent.
40	Adventurous, fearless. ....	Nomadic (?). ....	Literary.
45	Combative, thalassophilic. ...	Thalassophilic. ....	Combative.
46	Adventurous, combative. ....	Combative. ....	Thalassophilic.
47	Adventurous, diplomatic. ....	Combative, loyal. ....	Combative.
49	Hyperkinetic, adventurous. ...	Combative. ....	Administrative.
50	Thalassophilic, pertinacious, audacious, diplomatic.	Combative, thalassophilic.	Combative, thalassophilic.
53	Thalassophilic, combative, adventurous.	Combative. ....	Thalassophilic, adventurous.
54	Ill-tempered, thalassophilic, diplomatic.	Thalassophilic. ....	Ill-tempered, nomadic.
56	Thalassophilic, fearless, administrative.	Administrative (?). ....	Combative.
61	Thalassophilic, administrative.	Administrative. ....	Thalassophilic, brave.
63	Hyperkinetic, restless, diplomatic.	Diplomatic. ....	Hyperkinetic.
64	Fearless, judicious, diplomatic, combative, nomadic.	Thalassophilic (?). ....	Combative, diplomatic.
67	Nomadic, fearless, energetic. .	Nomadic, combative. ...	"In commerce."
68	Combative, nomadic, hyperkinetic, administrative	Thalassophilic, nomadic, combative.	Administrative.
16	Hyperkinetic, adventurous. ...	(?).....	Hyperkinetic.
21	Administrative, audacious, combative.	Combative. ....	Administrative.
25	Combative. ....	Combative. ....	Legal.

Table 7 may be still further summarized as follows: There is evidence of *thalassophilia* in the maternal side of the propositus in 7 cases, on the paternal side in 5. *Restlessness*, *nomadism*, or *adventuresomeness* appear 6 times on the maternal side and 6 times on the paternal side. *Hyperkinesis* (energy) is mentioned 3 times on the paternal side and not at all on the maternal; but *combative* is indicated 10 times as a characteristic on the maternal side and 7 times as a characteristic on the paternal side. *Diplomatic* is mentioned twice on maternal side and once on paternal; *administrative* is recorded 2 and 3 times and *courageous* 1 and 1 times on maternal and paternal sides respectively. Similar traits in about similar proportions are thus shown on each side when the close relatives of the propositus are considered *en masse*. What the table brings out clearly is that the successful naval officer arises in families that have in other instances shown the traits upon which his success has depended.

## THE INHERITANCE OF SPECIAL TRAITS OF NAVAL OFFICERS.

## THALASSOPHILIA, OR LOVE OF THE SEA.

*Source of Thalassophilia (or Sea-lust) in Naval Officers.*—The sea makes to different people a varied appeal. There are those who dread to go upon the great waters; there are those who have a genuine mania for the sea. The love of the sea, sea-lust or *thalassophilia*, is apparently a specific trait to be differentiated from wanderlust or love of adventure; several sailors with whom I have spoken (at Sailors' Snug Harbor), while they admit a strong love for travel on the sea, deny that they care for travel on land; conversely, the gypsies are notorious as wanderers, but are not notorious as sailors. Also, it is clear that many find their love of adventure fully satisfied by fighting Indians or living on the frontier as cowboys, etc., and have no longing for the sea. Moreover, the modern merchant vessel plying between New York and Liverpool offers, in times of peace, as little probability of adventure as that of conductor on a railroad train; and we have seen, on the increase of danger from submarines, seamen declining to undertake trips on the sea because of the added hazard of the trip; so that it is not adventure that leads them to become seamen. To the landsman the sea is often regarded as exceedingly dangerous; how, then, does it happen that some persons have been lured to undertake the discomfort, disease, and dangers of life on the sea, even from an early age of life, and at an era when little regard was had for the comfort or even health of the sailor. It is because men are driven into sea life by their instinctive fondness for the sea.

That sea-lust is an inherited, racial trait is demonstrated by its distribution among the races of the globe. It is natural that races with a sea-lust should make their way to the seacoast; and so we find Phoenicians, Carthaginians, and even Romans developing great marine fleets. That it is not proper to conclude that peoples are sea-lovers merely because they live on the sea is illustrated in the history of the Jews, who (though located on the Mediterranean, but without good natural harbors) were never a great maritime people. Even the Greeks, though realizing at times their dependence for national existence upon ships, were aroused with difficulty before the battle of Salamis and declined readily after the Syracusan expedition (415–413 B.C.). The Turks rose to sea-power only during a part of the sixteenth century. The great naval nations of the modern world have been the English, Scandinavian, and Dutch; though France, Spain, and Portugal have at times had great fleets and great sea fighters. Though the marine commerce of the Germans has risen in recent years to the first rank, their great navy has won no important victories. During the early part of the nineteenth century our coastal states (settled largely from England, Sweden, and Holland) produced great sea fighters, and during the War of 1812–1814 inflicted a series of humiliating defeats on the English navy.

While few of the native African tribes, though fronting on the sea, developed significant sea-power, and though even the Chinese were not given to long voyages, yet the Polynesians are the most maritime of all peoples and centuries ago traversed hundreds of miles of ocean in open canoes and proved themselves such gallant fighters that they conquered remote inhabited countries, like New Zealand, which they reached in their journeys.

That sea-lust is a racial trait is recognized by seamen themselves, who hold themselves apart as a different race from the "land-lubber." Seamen know very well that their cravings for the sea are racial — "it is in the blood," they say.

As Hoppin (1874, p. 19) writes: "The sea is a magnet that draws its own to it wherever they may be. . . . The love of the sea is one of the instincts that are original in the nature of some."

Just what there is in the sea that makes the appeal is a question. I have repeatedly inquired of sailors, especially at Sailors' Snug Harbor, Staten Island, as to this matter. Some reply naively that there was a good living to be made on the sea and therefore they naturally entered upon it. One can imagine that if one asked a tern why it lived on the sea instead of inland, like robins, it might reply because "I get my food from the sea." It is more in accordance with correct thinking to conclude that a tern feeds on the sea because its instincts lead it to live on the sea; and a fisherman or a sea captain finds his living on the sea because, fortunately for him, he can make a living where his instincts draw him. As Robert Hare, 1810, wrote concerning the adoption by America of the policy of abandoning the sea: "The utter impossibility of enforcing this abandonment in practice has already been demonstrated. A portion of our countrymen are amphibious and we might as well forbid the birds to fly or the fishes to swim as deny them access to their favorite element."

Other seamen have told me that it was the "romance of the sea" that attracted them. One stated that it was the form of the ship with sails spread that lured him; and to the visualist this sight makes a strong appeal. We have the statement that John Rodgers as a boy left his home at Havre de Grace and walked to Baltimore because he wanted to see a square-rigged ship. Also, many sailors have been visualists, fond of objects of natural history of all sorts, bringing home collections of shells and fruits and works of "savage" art to find place in local museums. Still, this is not the whole explanation, for a steady stream of applicants for the navy continues, even in time of peace, despite the replacement of sails by steam.

One sailor suggested that the young man who has returned from the sea carries a glamor of romance and heroism that attracts young women and enables him to make a better marriage selection. This would naturally be a strong incentive and, no doubt, in sea-loving communities like Salem, Marblehead, Sag Harbor, etc., it played an important part in securing the mating of two thalassophilic strains and in establishing a



pure thalassophilic race; but as an explanation of sea-lust it seems to me inadequate: first, because only certain of the young men of the community have the sea-lust; second, because only certain of the young women are thus especially attracted toward seamen. It seems probable that such young women belong to a strain that carries sea-lust; and that the eugenic explanation of love of the sea is one that applies only to maritime communities.

It seems probable, indeed, that sea-lust is a definite instinct which has appeared in a few strains of mankind. It appeared in the Vikings, who doubtless carried it to England and perhaps to the Netherlands. It appeared in the Phœnicians and in their colonies of Carthage and Syracuse and possibly of the east coast of Spain. No doubt the trait of sea-lust has arisen in other strains. However it has arisen, in some way it has got into a population and through consanguineous matings it has increased until it is found in a marked proportion of the population, which we then speak of as a great maritime people.

The decline of a great maritime people is likely to coincide with a great naval defeat. Says Admiral Bridge (*Encycl. Brit.*, xxiv, 552): "A remarkable characteristic of sea-power is the delusive manner in which it appears to revive after a great defeat." This failure properly to revive may be due to the heavy loss in the first defeat of germ plasm with the sea-lust, such that sufficient regeneration of it can not occur. The navy may be rebuilt, but "artificially" so, to use Bridge's term, and lacking in sailors with the real instinct. Apparently the Spanish fleet which met defeat off Cuba in 1898 lacked sailors with the proper hereditary traits. Of sea-power Bridges says: "To reach the highest degree of efficiency it should be based upon a population naturally maritime."

Sea-lust, it must be conceded, is a fundamental instinct, and a man who has it is as clearly differentiated from one who lacks it as a tern is differentiated from a thrush in its choice of habitat. The presence of the instinct shows itself in a desire for life on the broad expanse of the waters. It seems to be the opposite of the trait known to psychiatrists as "claustrophilia," or the feeling of contentment when surrounded by walls and living in a spacially restricted world. Thalassophilia, on the contrary, is a love of limitless expanse of horizon and of area for movements over the face of the planet. Traveling on land does not satisfy the instinct because movements are less free and the horizon more restricted. No doubt the changing color and moods of the water, the sun, and clouds, the dangers, the novel scenes in distant parts, all constitute part of the pleasurable sensations which lure the freedom-loving sailor or naval man.

*Heredity of Sea-lust.* — One of the most striking characteristics of sea-lust is that it is almost wholly a male character, apparently much more so than nomadism; quite as much so as the beard. Even among the Polynesians the women are not given to going to sea. This may be in part due to the *mores*; since to sit in a boat was formerly for a woman taboo in the Marquesas Islands. Sea fighting is not wholly unknown

among women, as the two cases of Mary Anne Talbot and Hannah Snell (Encycl. Brit.) indicate; but the rarity of such cases suggests that they are examples of psychic sex inversion. Nomadism, which leads to a fondness for travel equally on land or sea, is not rare among women; and the wives of sea captains not infrequently accompany their husbands; but these are not typical cases of sea-lust. It is possible, accordingly, that the irresistible appeal of the sea is a trait that is a sort of secondary sex character in males of certain races, just as a large rose comb is a male characteristic in some races of poultry. Females of the race have rose combs, to be sure, but they are relatively small things; but the sons of such females have huge combs again. As the great development of the comb of the cock occurs under the stimulus of the secretions of the male germ gland, so the appeal of the sea develops under the secretion of the germ gland in the boy or young man who belongs to a thalassophilic race. The behavior of this secondary sex character in heredity seems to be like this: If the father is thalassophilic and the mother belongs to a nonthalassophilic race, the sons will not be thalassophilic, as we see in the case of the sons of Hiram Paulding. When, on the other hand, both father's and mother's close male relatives are thalassophilic, probably the entire fraternity of the propositus will be so. This particular combination is less often realized than would be useful for testing this hypothesis. The following cases realize it approximately:

36, PREBLE. Father, sailing master and brigadier general; mother's father, a ship-master; sons: 1, Edward, commodore; 2, Ebenezer, a distinguished merchant of Boston; 3, Joshua, little known; 4, a sea trader from 16 to 61; 5 a sea trader.

As in those days the merchants often sailed, or sailed with, their ships, Ebenezer was probably attracted to the business of merchant through a love of the sea, or began as a sailor before he was a merchant.<sup>1</sup> If we suppose this to have been the case with Ebenezer (and omitting the little-known Joshua), then all 4 of the known sons of this mating were thalassophilic.

Again John Adolph Dahlgren married the daughter of a merchant and had 3 sons. One became a commander in the navy, and the other 2 were fighters in the Civil War. Of these, 1 died in battle at the age of 22; the other became United States consul at Rome.

George Smith Blake married the daughter of Commodore James Barron. Their only son was Francis Blake, who became a lieutenant commander in the navy during the Civil War and was a gallant fighter.

Captain Moses Brown married a Coffin of Newburyport, a center of sailor-folk. Of his 4 sons we know nothing about the youngest. Of the others, 2 became sea captains and 1 a cooper on shipboard.

<sup>1</sup> Marvin, W. L. (1902. *The American Merchant Marine*. New York: Scribners. 444 pp.), says p. 81: "Every capable officer (of a ship) of those times looked forward to becoming a merchant himself." In the E. R. O. records (57: 462) we find: "J. S. (born 1748) early engaged in commerce with the West Indies and commanded his own vessels." He served in the navy during the Revolution.

Admiral David Dixon Porter married a daughter of a commodore in the navy. Of their 4 sons, nothing was found about Richard. Essex became a major in the United States army; C. P. Porter served in the United States Marine Corps, and Theodoric served 43 years in the navy, retiring when he was a commodore.

John Ancrum Winslow, whose father was in commerce, married his paternal *cousin* and of his 2 sons one was a paymaster in the navy and the other became a commander in the navy.

I add two examples from the Eugenics Record Office files:

CASE 1. The *father* was "passionately fond of the sea and of marine sports"; he also liked to travel and became a man of great business ability. His mother's father was a ship captain. The *mother* was of a retiring disposition and fearful of ships and the sea; but her father traveled widely, especially at sea, had a clear wanderlust and little business ability. The children were 2 sons and a daughter. One son was extremely fond of travel, geography, ships, and the sea, and was without business ability. The second son is fond of aquatic sports, but hates travel and has good business ability. The daughter is fond of social activity. (E. R. O., Cor — 3.)

CASE 2. The *propositus* lived on the sea for many years, served in the Civil War, went out to Missouri, after a year returned to Pennsylvania, and settled down to farming. His mother's brother was a sea captain. (E. R. O., 28: 155.)

Thus we see that thalassophilia acts like a recessive, so that, when the determiner for it (or the absence of a determiner for dislike) is in each germ-cell the resulting male child will have a love of the sea. Sometimes a father who shows no liking for the sea, like Perkins's father, may carry a determiner for sea-lust recessive. It is theoretically probable that some mothers are heterozygous for love of the sea, so that when married to a thalassophilic man half of their children will show sea-lust and half will not.

#### THE HYPERKINETIC QUALITIES OF THE FIGHTERS.

Studies made on other and more extensive material have led (Dav-enport, 1915, p. 94) to the conclusion that hyperkinesis is a dominant condition and passes through the generations without skipping any. The tendency is equally apt to be shown in father or mother, and not commonly in both. Of our 67 naval officers, 31 may be reckoned as primarily fighters and, as such, most are of the hyperkinetic type. This total includes Nelson, who is equally great as strategist and tactician, and Oliver Hazard Perry and David Porter, jr., who are not on our main list. Of these 30 the hyperkinetic tendency apparently comes from the paternal side in 15, namely: Blake, Cochrane, Dewey, Foote, Keppel, Lawrence, Macdonough, Morris, Perkins, O. H. Perry, David Porter, D. D. Porter, Smith, Stockton, Tromp. The hyperkinesis apparently comes from the maternal side in 6 cases; namely, Beresford, Cushing, Keith, Nelson, O'Brien, Wolseley. In 1 case it probably came from both sides, namely, Farragut; in the 8 remaining cases the temperament of neither parent is sufficiently known. There are

apt to be more cases of hyperkinetic fathers than mothers, since biographers tend to consider the latter less fully than the former.

Though the evidence of the biographies is, in some cases, not satisfactory, yet the hyperkinesis of the propositus is usually shown in some degree by one of the parents also.

TABLE 8. — *Vocations of the grandchildren of naval officers.*

Name.	Sons' sons.	Daughters' sons.
Barney . . . . .	1, inventor.	
Buchanan . . . . .	2, commander in Confederate navy.	1, Naval Academy, youngest member of class.
Cochrane . . . . .	1, lieutenant general.	
Dahlgren . . . . .	2, lieutenant colonel in army.	
Duncan . . . . .	1, . . . . .	1, 2, young.
Flinders . . . . .	2, professor of biology.	
Hawkins . . . . .	1, member of Parliament.	1, leading British Egyptologist.
Howe . . . . .	1, went to sea.	
Morris . . . . .	2, 3, . . . . .	1, 2, . . . . .
Paulding . . . . .	1, United States Military Academy; captain of artillery . . . . .	1, lieutenant, United States navy.
Pellew . . . . .	2, ensign, United States navy.	3, rector.
Perry, O. H.	3, in insurance business . . . . .	1, in naval reserve.
Perry, M. C.	2, farmer . . . . .	2, 3, not in navy.
Perry, C. R.	1, commander, Royal Navy. 2, . . . . .	
Preble . . . . .	3, officer in Madras cavalry.	
Rodgers, John	4, lieutenant in Royal Navy. 5, major in infantry.	
Rodgers, G. W.	1, author.	1, rear admiral.
	2, . . . . .	2, rear admiral.
		3, 4, bankers.
		5, graduate of U. S. Naval Academy; 2 years in navy.
	1, lieutenant United States navy . . . . .	1, rear admiral.
	2, graduate West Point . . . . .	2, naval commander.
	3, physician . . . . .	3, naval captain.
	1, commander in navy.	4, soldier.
	1, commander in navy . . . . .	1, brigadier general, United States army.
	2, rear admiral <sup>1</sup> . . . . .	2, 3, majors.
	3, rear admiral <sup>1</sup> . . . . .	4, engineer.
	1, captain, United States army.	
	2, lieutenant United States navy. <sup>2</sup>	
	3, rear admiral. <sup>2</sup>	

<sup>1</sup> Also daughter's sons of M. C. Perry.

<sup>2</sup> Also sister's sons of Alexander Mackenzie, naval officer and brother (with change of name) of Jane Slidell, who married M. C. Perry, and Julia Slidell, who married C. R. P. Rodgers.

TABLE 9. — Summary of Table 8.

Classification.	Son's sons.		Daughter's sons.	
	No.	Per cent.	No.	Per cent.
Naval officers.....	10	40	10	56
At sea.....	1	4	..	..
Army officers.....	7	28	3	16.5
Inventor.....	1	4	..	..
Professor of biology.....	1	4	..	..
Member of Parliament.....	1	4	..	..
Insurance business.....	1	4	..	..
Farmer.....	1	4	..	..
Author.....	1	4	..	..
Physician.....	1	4	..	..
Egyptologist.....	..	..	1	5.5
Rector.....	..	..	1	5.5
Not in navy.....	..	..	2	11
Engineer.....	..	..	1	5.5
Total.....	25	100	18	100

SOURCE OF NOMADISM IN NAVAL OFFICERS.

Nomadism is a trait which leads its possessor to restlessness, change of scene, travel. The manifestation of this trait is often periodic. It is shown more in early than later life. Typical nomads, like gypsies and Bedouins, are satisfied with roaming over the land; the "sea rovers" have, there is reason for thinking, another and different instinct: a love of the sea, thalassophilia. That these two instincts are distinct is shown by the fact that many sea rovers have a distaste for travel on land, or at least find little satisfaction on it. Foote wanted to go to sea against his parents' wishes and was entered at West Point as a compromise; but this did not satisfy, so he transferred to the navy.

Nomadism appears to be a simple "unit character" whose germinal determiner is sex-linked, i. e., is found only in such sperm cells as produce female offspring. This matter has already been worked out at the Eugenics Record Office (Davenport, 1915).

Since nomadism is an important element that leads to a naval (as well as to a military) career, it is interesting to inquire whether, in the mass, there is any difference between males and females in the tendency to have naval sons. To make the comparison we must consider in parallel columns the distribution of occupations in the sons of persons who hold exactly similar relationship to the propositus. An attempt has been made to do this in table 8.

TABLE 10. — Showing for the respective histories the frequency of occurrence of various occupations among the brothers of the father and the mother respectively of the propositus.

Occupations.	Father's brothers.	Per cent	Mother's brothers.	Per cent
	<i>History Nos.</i>		<i>History Nos.</i>	
Naval officer.....	5, 11, 20, 32, 42, 43, 53, 59 (bis), 61 (bis).....(11)	25	32, 44, 55, 68	20
Lost at sea.....	43, 50	5	13	5
Merchant sailor.....	43, 58	5	27	5
Army officer <sup>1</sup> .....	5, 11 (3), 39, 63	14	28, 47, 49, 68	20
Soldier in Amer. Revolution	36 (bis)	5		
Naval surgeon.....	6, 14	5		
Pioneer.....	37	2	25	5
Hunter.....	5	2		
Clergyman.....	11, 28 (4)	12	16, 32	10
Surveyor.....			27	5
Baron of exchequer.....			31	5
Commerce, trade, and plan- tations.....			25	5
Judge.....	5, 46 (bis), 59	9	10, 49, 63 (bis)	20
Merchant.....	10	2		
Physician.....	17, 50	5		
Farmer.....	43, 60	9		

<sup>1</sup> Excluding a number of the less important English army officials.

TABLE 11. — Absolute and percentage frequency of occurrence of each of several classes of occupations among sons of the brothers and the sisters, respectively, of the proposituses.

Classification	Brother's sons (10).		Sister's sons (8).	
	Frequency.	Per cent.	Frequency.	Per cent.
Naval officers.....	13	30	10	56
Army officers.....	9	21	3	16.5
Farmers.....	2	5	....	....
Civil service.....	3	7	....	....
Sailors.....	6	14	1	5.5
Merchants.....	2	5	....	....
Shipmasters.....	4	9	....	....
Miscellaneous.....	4	9	2	11
Surgeon in navy.....	....	....	1	5.5
Clergy.....	....	....	1	5.5
Total.....	43	100	18	100

In comparing for the families of naval officers the contribution of the paternal and maternal sides we should first compare the occupation of *male* relatives on the two sides holding similar relationship to the propositus, and accordingly we compare the brothers of the father and of the mother. Unfortunately the number of such relatives of which the occupation is known is not large on either side—larger on the paternal than the maternal just because biographers always lay more stress on the paternal side.

The foregoing tables lead to the conclusion that, on the whole, male relatives of naval officers who are related to the propositus through females are somewhat (40 per cent) more apt to be naval officers than those related through males. Since this is the method of inheritance of nomadism, the excess is probably due to an inheritance of nomadic instinct in some naval men.

#### IV. CONCLUSIONS.

In making selection of untried men for naval commissions advantage may well be taken of the assistance that is afforded by the facts of juvenile promise and family history. Naval fighters are chiefly hyperkinetics. In their youth they were nomadic, thalassophilic, adventurous. Future strategists have in more than one instance arisen from boys who succeeded in carrying out their plan of leaving homes to go to sea. Administrators have been rarely quarrelsome. The adventurous type of admiral was markedly adventurous in his youth. The juvenile history gives a precious indication of future success in the navy.

It is probable that if there is not a history of love of the sea in close male relatives on at least one side the youth will not become a great sea captain or naval officer. It is usually true that one of the parents should be a hyperkinetic, especially if the son is to be a successful naval fighter. Since naval officers are frequently nomadic, and since nomadism is sex-linked, an untried candidate whose family history shows naval men on the maternal side only is more apt to be successful than one showing instances of naval men on the paternal side only.

In general, unless a candidate shows a history in youth of adventurousness and thalassophilia, it is improbable that he will make a great naval officer. Unless he has a hyperkinetic temperament it is not probable that he will make a successful naval fighter. Unless a love of the sea appears on at least one side of the house, hyperkinesis in at least one parent, or a case of an eminent naval man among the male relatives of the mother, one is justified in doubting if the applicant for a naval commission will become an eminent officer.

#### V. APPLICATION OF PRINCIPLES TO SELECTION OF UNTRIED MEN.

Admitting that a knowledge of juvenile promise and family history might assist in the selection of untried men for commissions, the practical question remains: How can such knowledge be obtained promptly enough to aid in officering a new army? Every new undertaking requires methods of its own. The acquisition of facts of juvenile promise and of family history requires the use of persons trained in this work. A body of such workers has already been organized and has been doing work of this sort since 1910. They are the eugenics field workers of the Eugenics Record Office. These field workers constitute a body of about 130 picked women and men, mostly col-

lege graduates and especially trained in psychology and psychiatry. They are located throughout the country from California and Utah to Maine and North Carolina and from Minnesota to Louisiana. Through these field workers as a nucleus, a body of investigators sufficient to report on the personal and family history of 50,000 men in three months could be organized and the cost would be less than two days' pay for each person considered.



## PART II.

### BRIEF BIOGRAPHIES OF NAVAL OFFICERS, WITH ESPECIAL REFERENCE TO THEIR JUVENILE PROMISE AND THEIR PERSONAL TRAITS.

The brief biographies of naval officers in these pages are written according to the following plan. First is an account of the achievements and other events in the life of the man. In a few cases it has been found convenient to include here details of the man's juvenile reactions. The second part of the account is an analysis of the traits or "gifts" which have colored or determined the output of the subject. In this treatment there are often considered similar reactions of the man's kin and the development in the individual of each of these gifts. In some cases, in default of details concerning the kin, a mere outline of the man's genealogy is given.

In reading the biographies the pedigree charts (when furnished) should be frequently consulted. These charts (with their rather full legends) serve to show the position in the family tree of the relatives named in the text and to give some idea of the distribution of traits throughout the genetic complex. All children of a fraternity, whether eminent or attained to maturity or not, are given in order that the "density" in the family tree of the special gifts may be measured. Names of persons and places are given rather fully, as they may help the student in other pedigree investigations. As the charts are highly condensed representations of descriptive facts some account of the way to interpret them is given below.

#### KEY TO PEDIGREE CHARTS

Each symbol represents a person: □ males, ○ females. All symbols suspended from the same continuous horizontal line constitute one fraternity. The vertical line leads upwards from the fraternity line to the short horizontal line connecting the parents of said fraternity. Dotted lines . . . . . indicate illegitimacy. Dot-and-dash line —. —. — means mere descent without attempt to represent the generations. The generations are numbered at the left from top to bottom; the individuals in each generation are numbered from left to right for ease of reference. The chronological order of individuals in the fraternity is usually not indicated by the order on the chart. A number inside of or just below a symbol indicates that the symbol stands for that number of individuals.

The following is a key to the special marks on the symbols.

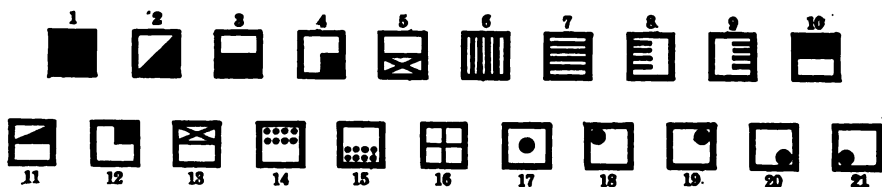

- |  |  |                        |
|--|--|------------------------|
| 1. Naval officer, usually of rank of captain or higher.                                | 5. Sea traveler or ship's surgeon.       | 14. Administrator.     |
| 2. Naval officer of low rank (usually lieutenant or lower) or of slight eminence.      | 6. Of naval promise; died young.         | 15. Legislator.        |
| 3. Seaman, including captain of a merchantman.   | 7. Nomad.                                | 16. Clergyman.         |
| 4. "Merchant" of the old days, interested in shipping, sometimes going with his cargo. | 8. Reformer.                             | 17. Fearlessness.      |
|  | 9. Explorer.                             | 18. Authorship.        |
|  | 10. Army officer.                        | 19. Inventiveness.     |
|  | 11. Army officer of unrealized promise.  | 20. Musical capacity.  |
|  | 12. "In army."                           | 21. Artistic capacity. |
|  | 13. In army service, but not as fighter. |                        |

## 1. WILLIAM BAINBRIDGE.

WILLIAM BAINBRIDGE was born at Princeton, New Jersey, May 7, 1774. He was educated under the direction of his mother's father and at the age of 15 became a sailor on a merchant ship about to sail from Philadelphia. Such aptitude did he show that at 18 he was made first mate of a ship in the Holland trade. During his first voyage as mate the crew mutinied, but he rescued her commander and suppressed the uprising; in consequence, he was made captain of the vessel at 19 and continued for many years in the merchant service. He had remarkable power with crews; he was once called upon by the captain of another vessel to quell a mutiny and succeeded in doing so. Once, coming out of the harbor of St. Thomas, he was fired on by a British vessel of 8 guns; with his 4 guns he kept up such an effective return fire that the antagonist surrendered, but he refused to take her as a prize. On one occasion one of his seamen was impressed; in reprisal he seized a seaman from the next English ship he met. His reputation led to his appointment as lieutenant in the newly organized United States navy, in which capacity he was in command of the schooner *Retaliation*. This schooner was shortly after, in 1798, captured by French frigates and he was held captive for a time and then released. During the next two years he protected American shipping around the West Indies and in 1800 was made captain for his eminent services. In the same year he commanded a frigate to convey tribute to the bey of Algiers and, through diplomacy in Turkey, reduced the haughty spirit of the bey. In 1801 his ship, the *Philadelphia*, was sent in a squadron against the Moors and he captured the Moorish cruiser *Meshboha*, but later he fell, with the *Philadelphia*, into the hands of the Moors and was held a prisoner until 1805. He then reëntered the merchant service, but upon the beginning of the War of 1812 was assigned to the command of the *Constitution*, which destroyed the British frigate *Java*; on his return he was set to work on the construction of the frigate *Independence*. Again, in 1815, he went against the Barbary States, now as commander of a squadron, and forced them to respect the American flag. After that he established a naval training school and served as president of the board of promotion of naval officers. For three years he was chief of the board of naval commissioners in Washington, District of Columbia. He died in Philadelphia, July 1833.

He had four daughters by his wife, Susan Hyleger, and also a son who graduated at Princeton with honor, studied, law, was "a ripe scholar" with pure principles and sound judgment, and "inherited sentiments of high honor and chivalry which distinguished his father." This son died as a young man.

William Bainbridge was vigilant, untiring in endeavor, exacting in discipline, and equal to any emergency. He sought rather than avoided responsibility. Ordinarily he was courteous and hospitable. About 6 feet tall, his frame was muscular and his dress neat. The traits that determined his vocation were as follows:

1. He was *thalassophilic*. He early became inspired with a desire to be a sailor and actually became such at the age of 15. From that time on he was for only short periods at a fixed land abode.

2. He was *adventurous and fearless*. As a boy his "dauntless spirit urged him into the foremost rank in every boyish enterprise where peril was to be encountered." As a naval officer he encountered antagonists superior to himself with a courage which did not consider too carefully the risk.

3. He was a *hyperkinetic*. He reacted quickly and vigorously. Herein lay his power with men who respect bravery, dash, and vigor. Like most hyperkinetics, he showed at times a violent temper, a fierce and vehement reaction. He spoke rapidly, but, when speaking vehemently, sometimes had difficulty in expressing himself. He inspired confidence and courage in others.

## FAMILY HISTORY OF WILLIAM BAINBRIDGE.

I 1 (M F), John Taylor, of Monmouth county, New Jersey, a citizen of wealth and respectability, much interested in the education of his grandson.

II 1 (F), Absalom Bainbridge, a physician who practiced in Princeton, New Jersey; later he removed to New York City, where he died in 1807. II 3 (consort's F), John Hyleger, of Holland, for many years governor of St. Eustatius, West Indies.

III 1 (Propositus), *William Bainbridge*. III 2 (consort), Susan Hyleger.

*Children of Propositus*: IV 1, ——— Bainbridge, was admitted to the bar at Philadelphia; later he removed to Pittsburgh; he died young, in 1831. IV 3, Captain Thomas Hayes, of the navy. IV 6, Ashbel G. Jaudon, a merchant of Philadelphia.

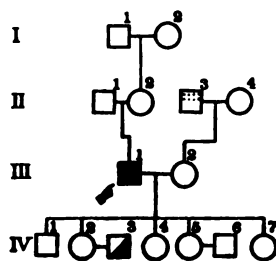

## BIBLIOGRAPHY.

HARRIS, T. 1837. *The Life and Services of Commodore William Bainbridge*. Philadelphia: C. Lea and Blanchard. xvi + 254 pp.

## 2. JOSHUA BARNEY.

JOSHUA BARNEY was born at Baltimore, Maryland, July 6, 1759. At the age of 13 he left his father's farm and became an apprentice on a small brig going to Liverpool and made numerous other voyages on her. Three years later, the captain having died on board and the first mate having abandoned the vessel, the 16-year-old lad assumed command, made Gibraltar with his sinking ship, sold his cargo, and brought the vessel safely back to Baltimore. On the breaking-out of the Revolution he was taken as master's mate on the sloop-of-war *Hornet*, later was transferred to the *Wasp*, and in a fight with a British brig so distinguished himself that he was appointed lieutenant in the navy. Later, he was captured by the British and confined for five months in a prison ship, exchanged, and again captured and again exchanged. As an officer of the *Saratoga* he led in the boarding of three British vessels, but these were recaptured the next day and he was put in prison at Plymouth, England, for nearly a year. He escaped twice and made his way to Philadelphia. In 1782 he took command of a gunboat and captured a war vessel of greater armament than his own. He engaged in business at the close of the war, going frequently on trading voyages. In 1795 he entered the French navy with a rank corresponding to commodore, but he resigned in 1800. On the outbreak of the War of 1812 he offered his services, was commissioned captain in the navy, and given command of a flotilla for the defense of Chesapeake bay. Here he received a wound in the leg, from the effects of which he died four years later.

The traits of Joshua Barney that determined his success were, first, a strong *nomadic tendency*. At 10 years he was through with school and wanted to go to sea; indeed, "long before this period he had wearied his father by continued entreaties to be a sailor." In his twelfth year he was entered on a pilot-boat, and

this so obviously accorded with his bent that his father placed him under the care of Captain Thomas Drysdale, the boy's brother-in-law, and he began his career as a seaman, described above. His nomadic tendencies manifested themselves on the land also. In 1786 he purchased lands in Kentucky, and in November 1787 set out to explore them. He became "very adept with a rifle and thoroughly enjoyed life in the wilderness." In 1816, urged by his old love of rambling, he again undertook a journey to Kentucky; he went again in 1818, and died at Pittsburgh on returning homeward.

A second trait was fearlessness, *intrepidity*. When he was 16 years old his captain died on a voyage, and when the first mate had left the ship he assumed command: "was neither dismayed by the additional weight of care and responsibility which thus devolved upon him, nor depressed by the perilous condition of the ship. . . . On the contrary, his courage rose with the occasion; the ship sprang a leak and he put into Gibraltar." This fearlessness led him to return again and again to naval service and to attempt to escape repeatedly after capture. "No dangers or difficulties could divert" him from his object.

In general, Barney was a *hyperkinetic*. Enthusiastic, ardent, energetic, with a ready wit, and a cheerful and entertaining companion, he was dearly beloved in his family circle, and "those who once served under him were always ready to offer their services a second time." He was, however, quick in anger. Once, when about to fire at the enemy, his captain forbade him and in anger Barney threw the match-stick at him and so cowed the captain that he withdrew to his cabin, while the youth assumed full command. Says his biographer: "When excited there was a lightning-like splendor in the coruscations of his glance that few persons could meet without perturbation."

It is a phase of the hyperkinetic nature that there was seldom much interval between decision and action. It was not so much that he was so prompt in making up his mind as that his mind did not interfere with his response. His liberality and indulgence to his children knew no bounds; he showed an uncalculating wastefulness of expenditure when at home; he relieved the distresses of the poor in the vicinity. For a brief interval after the wound in his leg he was greatly depressed, lost his facial glow, became emaciated. The society of his friends became irksome and he was peevish. From this mood he recovered after a few months. Physically, Barney had a close-knit, muscular, vigorous frame and was graceful.

#### FAMILY HISTORY OF JOSHUA BARNEY.

I 1 (F F), William Barney, emigrated in 1795 to Maryland, where he prospered and left a "handsome fortune" at his death in 1746. I 2, Elizabeth Stevenson.

*Fraternity of F*: II 1, Martha Barney. II 2, Richard Hooker. II 3 (F), William Barney (1718-1773), lived in Baltimore, but later removed to a farm about 8 miles from that town. II 4 (M), Frances Holland Watts, an heiress to a large property. II 5 (first consort's F), Gunning Bedford, an alderman of Philadelphia.

*Fraternity of Propositus*: III 1, Elizabeth and Peggy Barney. III 2, Margaret Barney. III 3, John Holland Barney (1742-1840). III 4, William Stevenson Barney (b. 1754) was a marine officer of Virginia; he is said to have kept a hotel in Georgetown. III 5 (second consort), Harriet Cole died in 1849. III 6 (*Propositus*), JOSHUA BARNEY. III 7 (first consort), Ann Bedford, died 1808. III 8, — Hindman. III 9, — Nicholson. III 10, Samuel Nicholson (1743-1813) was a lieutenant on the *Bon Homme Richard* under Paul Jones. In 1779 he was appointed captain; he superintended the building of the *Constitution* and was her first commander. III 11, James Nicholson (1727-1804), in 1776 was appointed ranking captain in the navy; in 1777 commander in chief of the navy. III 12, John Nicholson was appointed a captain of the navy in 1779.

IV 1, George Deverell, of Jamaica, West Indies. *Children of Propositus*: IV 3, Eliza Barney. IV 4, Joshua Barney. IV 5, Nathan Barney. IV 6, Hannah Carey. IV 7, William Barney (1781-1838), held the rank of major in the War of 1812 and was deputy naval officer for the port of Baltimore. IV 8, Louis Barney (1783-1850). IV 9, Anne Stedman Van Wyck. IV 10, Henry Barney, born 1790. IV 11, Caroline Barney, born 1787. IV 12, Nathaniel Williams. IV 13, Adele Barney. IV 14, Isaac Waddy. IV 15, John Barney (1785-1856), was a member of Congress from Baltimore, 1825 to 1829. IV 16, Elisabeth Nicholson Hindman. IV 17, James Rogers of Delaware.

*Children's children of Propositus*: V 1, Mary Deverell. V 2, Nathan Barney (1819-1902) was a well-known inventor; he organized the Barney Dumping Boat Company. His automatic dumping boat, used by the New York street-cleaning department, dumps 700 tons in 60 seconds. He invented fish-plates to hold the ends of railroad rails together. V 3, Elisabeth Wother- spoon, of New York. V 4, Joseph Nicholson Barney (1818-1899) in 1832 entered the United States navy, but resigned in 1861 to enter the Confederate States navy, with the same rank of lieutenant. For gallant service at Hampton Roads in the engagement between the *Monitor* and *Merrimac* he was made commander. He went to Europe to see to the fitting out of vessels for the Confederate States navy but his health failed in 1863. For a time he retired to farm life in Virginia but afterwards engaged in the insurance business. V 5, Eliza Jacobs Rogers.

*Children's children's children of Propositus*: VI 2, George Deverell Barney (b. 1865), a surgeon of note; he devised a new treatment for consumption and demonstrated the communicableness of bovine tuberculosis to man. VI 3, James W. Barney, cashier of a Kansas City bank. VI 4, Thomas Holcomb. VI 5, Elisabeth Barney.

*Children's children's children's children of Propositus*: VII 1, Rebecca Holcomb. VII 2, James and Thomas Holcomb. VII 3, Franklin Porteous Holcomb (born 1884) graduated from the United States Naval Academy at Annapolis.

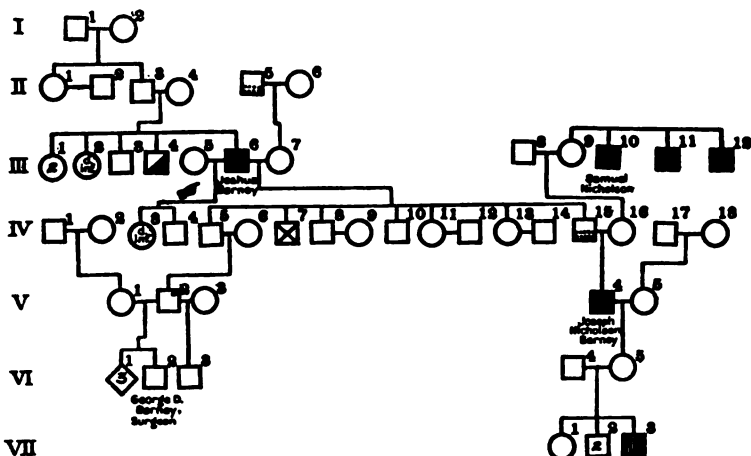

BIBLIOGRAPHY.

ADAMS, W. F. 1912. Commodore Joshua Barney. Privately printed. Springfield, Massachusetts. 228 pp.  
 BARNEY, MARY. 1832. A Biographical Memoir of the late Commodore Joshua Barney. Boston: Gray and Bowen. xvi + 328 pp.

## 3. JOHN BARRY.

JOHN BARRY was born at Tacumshane, Ireland, in 1745. He went to sea when a boy and commanded a vessel when in his twenty-first year. At 21 years of age he emigrated to Philadelphia and sailed merchant ships until 1775, when he arrived from England in the *Black Prince* just as the Continental Congress had resolved to fit out two armed cruisers. He offered his ship and his services, and was commissioned captain of the 16-gun brig *Lexington*. Thus he was the first officer appointed in the new navy. In April 1776 he captured his first prize, an English vessel, and carried her to Philadelphia. He did some privateering until October 1776, when by an act of Congress he was appointed captain of the *Effingham* (28 guns), which lay in the Delaware river above Philadelphia. Before taking to sea, however, he organized a company of volunteers to assist Washington, who was retreating from Trenton but blocking the progress of the British toward Philadelphia by land. Returning to his vessels, Barry received orders to sink the *Effingham* to prevent her capture; this he reluctantly did after some delay. Shortly after, he manned four small boats, passed Philadelphia at night, and captured a larger schooner of 10 guns and four British transports. All of these he destroyed to prevent them from being recaptured. This undertaking won admiration from both sides and an offer from the British of £20,000 and command of a squadron, which he indignantly refused. During the following years of the war Barry had a series of encounters with the enemy at sea. In June 1780, in command of the *Alliance*, a 32-gun frigate, he sailed from France with Colonel Laurens, commissioner to France. On the outward trip he captured a privateer. Returning with his ship loaded with dry goods, he captured two privateers on April 2 and on May 28 ran upon two more. As the wind subsided he was at the mercy of his antagonists for an hour and was wounded; then, as a breeze sprang up, he sent the *Alliance* between her two antagonists and delivered such a fire that both vessels struck. In August 1782, in a brief three-weeks' cruise from New London, he captured eight vessels. In 1783, returning with specie from the West Indies, he was attacked by three frigates; despite the heavy odds against him he fought bravely until, a French vessel coming to his assistance, the British ships sailed away. This was the last naval fight of the Revolution. Captain Barry was one of the delegates to the convention at Philadelphia to revise the Articles of Confederation. On the last day but one of the session the resolution to refer the Constitution to a convention of the States was before the house. Postponement until afternoon was asked for and granted; members who were opposed to the bill kept away in the afternoon to prevent a quorum. Two additional members were required, and Captain Barry led a party that carried by force two members from their rooms to the meeting, thus securing a vote. When the new navy was formed Barry was the first of the six captains named by Washington. In 1797 he completed building the frigate *United States* and was placed in command of her. He was authorized, in 1798, to capture armed French vessels, and did so effectively. He died September 1803.

John Barry was a *hyperkinetic*. His reactions were wonderfully quick and his judgment correct. "The promptitude and propriety of Captain Barry's decisions on sudden emergencies was wondered at and admired. Waked out of sleep, on deck in an instant, and all hands set to work, whether it be in the case of a vessel in sight, a violent gale, or otherwise, and the propriety of the order appeared in no countermanding becoming necessary." His passions on some occasions were

violent. Thus, once in hoisting a foretopmast steering-sail a blunder was made and twice repeated; Barry flew forward like lightning and struck the boatswain with his trumpet; yet he was affectionate toward his men. In the case of the boatswain whom he had hit with a trumpet, he later visited him in his cabin and expressed sorrow for the violence of his passion. Barry liked fun, and often gave the call, "all hands to play." It was his prompt decision and his intrepidity that enabled him to attack and overcome superior forces of the enemy.

Of Barry's relatives little is known. On his mother's side he is said to have been descended from John Stafford, an officer in Cromwell's army. Barry married, but left no children.

## BIBLIOGRAPHY.

MARTIN, I. J. 1897. *The History of John Barry*. Philadelphia: The American Catholic Historical Society. 261 + xiv pp.

## 4. PHILIP BEAVER.

PHILIP BEAVER was born at Lewkner, England, in 1766. At the age of 11 he wanted to go to sea, and shipped under Admiral Keppel, who in 1778 fought that French squadron commanded by D'Estaing which had been sent to help the American colonies. Beaver was in the battle between the two squadrons at St. George's Bay. The lad studied navigation and naval astronomy with the ship's mate. At this time his temperament was prevailingly buoyant, with sedate spells. Later he cruised in the Windward Isles, destroying Spanish and French vessels. At the age of 16 he was placed in charge of a prize American brig, but this was recaptured and Beaver was taken prisoner and later exchanged. He was placed on a naval privateer and navigated a prize to port; had a dangerous fever and was reported dead. At the close of the American war in 1783 he returned to England and went thence to Boulogne to learn French. In his other studies he was assisted by his brother, Rev. James Beaver, his preference being for history and natural philosophy. In 1789 he was appointed first lieutenant. He went on a colonizing venture to an island off the coast of Sierra Leone, but this was a failure. He went on the *Stately*, 64 guns, to take the Cape of Good Hope from the Dutch; his handling of his ship in a squall attracted admiration and he was transferred to the flagship. He was with Keith in the Mediterranean, watching the Spaniards in 1799, and was sent to carry five prizes to port. As assistant captain under Keith, he had charge of the bombardment of Genoa, which capitulated to him, but after he had sailed for England it was lost again. In 1801 he was sent to help expel the French from Egypt, and after that cruised in the Mediterranean and made charts for the Admiralty. In 1810 he was one of the squadron that captured Mauritius and as senior officer remained in command at the Mauritius station, and in that capacity captured the Seychelles Islands. He then proceeded against Batavia, in the capture of which in 1811 he played an important part. Seeking mast timber in East Africa, he was taken ill and died at Cape Town of "inflammation of the bowels."

Beaver was a slender man, capable of great fatigue of body and mind. He was scholarly rather than pugnacious. He knew well the science of navigation, preferred reading and writing in his cabin to pacing the deck, and wrote an account of some of his campaigns. On shipboard he was firm, almost austere; but gentle and playful on shore. He was courageous in carrying out what he undertook.

Of Beaver's family we know little. His father was a clergyman who died in straitened circumstances. The father's father was Herbert Beaver, a man of wit and urbanity. The mother, Jane Skeeler, was the daughter of a clergyman, Rev. Thomas Skeeler. Of the sibs of Captain Philip Beaver, one brother was a major and died in the East Indies, and another was a clergyman; a sister married John Gillies, an author of historical works.

FAMILY HISTORY OF PHILIP BEAVER.

I 1 (F F F), Edward Beaver, a clergyman.

II 1 (F F), Herbert Beaver, of Oxford. II 3 (M F), Thomas Skeeler, a clergyman.

III 1 (F), James Beaver, a clergyman who studied at Oriel. III 2 (M), Jane Skeeler.

*Fraternity of Propositus*: IV 2, — Beaver, a major who died in the East Indies. IV 3, James Beaver, a clergyman. IV 5, John Gillies, a Scottish historian. IV 6 (*Propositus*), PHILIP IV BEAVER.

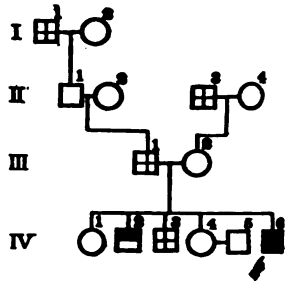

BIBLIOGRAPHY.

SMYTH, W. 1829. *The Life and Services of Captain Philip Beaver, late of his Majesty's Ship Nisus*. London: J. Murray.

5. CHARLES WILLIAM DE LA POER BERESFORD.

LORD CHARLES WILLIAM DE LA POER BERESFORD was born in Ireland in 1846, the second son of the fourth Marquis of Waterford. He entered the *Britannia* as a naval cadet in 1859; became lieutenant in 1868 and commander in 1875. He was in Parliament 1874-1880, as a conservative with special interest in naval administration. In command of the *Condor*, 1882, on the occasion of the Egyptian crisis, he won lasting renown and a captaincy by taking his ship in close to the forts and engaging them with conspicuous gallantry. He served in Egypt in 1884-1885, under Lord Wolseley, and commanded a naval brigade. He returned to Parliament in 1885, and in 1886 he became lord of the admiralty and worked for a stronger navy, but, not receiving adequate support, he resigned in 1888 with dramatic effect. In the House he succeeded in putting through the naval defense act of 1889. For four years more he was on the Mediterranean and then in command of the steam reserve at Chatham. Rear admiral in 1897, he alternated between Parliament, a mission to China on behalf of commerce and, in 1905, the command of squadrons and fleets; in 1906 he became a full admiral. He has stood always for a large increase in the English navy.

Charles Beresford's great daring was evidenced as a cadet and shown in his attack on Alexandria. At the Falkland Islands he found delight in shooting; at Vancouver he went hunting by canoe and stalked deer at night; in China he went out pig-sticking and tiger-shooting. He was always taking hazardous chances and won bets that involved courage and daring. This daring is shown in his brothers also. He says of them: "The five brothers were keen sportsmen, hard riders, men of their hands, high-couraged, adventurous." John, his eldest brother, became crippled while hunting. William won the Victoria Cross by cool and audacious gallantry in the Zulu war of 1879 and was renowned for his reckless hardihood. "There was hardly a bone in his body which he had not broken." "He might have been a great soldier, a great diplomat, a great political



officer, had not his passion for the turf diverted a part of his energies." Brother Marcus took charge of the King's race horses. Brother Delaval went to Mexico as a young man, where he was known as a dare-devil rider and an excellent rancher, rounding up his stock and branding his own cattle. He was killed in a railway accident.

Their mother, Christina Leslie, a daughter of Charles Powell-Leslie, became a noted rider to hounds after her fortieth year. Their father's father married a Delaval, of whom it is said they "would seem to have been a high-spirited, reckless, and spendthrift race." One of their ancestors, George Delaval, as vice admiral fought off Cape Barfleur, 1692. Their father's brother, Henry, was killed on the hunting field. A brother of their father's father, Admiral Sir John Poo Beresford (III 1), a natural son of the first Marquis of Waterford, was a great sea fighter, and another natural son of the first marquis, William Carr Beresford, was a great fighter but too impetuous and quick-tempered to be a great general. He made a great success as reorganizer of the Portuguese army. Thus Beresford's ancestry on both sides shows daring and adventurousness. His own father was a clergyman. The great-uncle, John Poo Beresford (III, 1) played a conspicuous part in Parliament and was junior lord of the admiralty, and another brother became primate of all Ireland. Earlier ancestors were members of Parliament.

Charles Beresford was a statesman of breadth of view, as is shown by his insistence on the needs of the navy; these views he successfully instilled into Parliament, and thus he became the father of the modern British navy.

Charles was jovial and full of pranks and practical jokes. At school he and his two brothers were known as the three "wild Irish." The Delavals were given to extravagant entertainments, to amateur theatricals, and to practical jokes. Like many of his relatives, Charles was beloved of his men and had a great influence over them.

#### FAMILY HISTORY OF CHARLES DE LA POER BERESFORD.

I 1 (F F F F) Sir Marcus Beresford, first Earl of Tyrone (1694-1763). I 2 (F F F M) Katherine, Baroness de la Poer. I 3 (F M M F) Lord Delaval.

*Fraternity of FFF:* II 1, John Beresford (1738-1805), appointed commissioner of revenue, became in fact ruler of Ireland. II 3 (F F F), George de la Poer Beresford, first Marquis of Waterford (1735-1800). II 5 (F F M), Elisabeth Monck. II 6 (F M F), George Carpenter, second Earl of Tyrconnel. II 7 (F M M), Lady Delaval, famed for her beauty.

*Fraternity of FF:* III 1, Sir John Poo Beresford (born 1768?), entered the Royal Navy in 1782 and rose to the rank of admiral after distinguished service in the West Indies and off Lisbon (1810). He was a conspicuous member of Parliament and junior lord of the admiralty. III 2, Viscount William Carr Beresford (1768-1854), "a born fighter and a great administrator," bore a distinguished part in the Peninsular war, during which he was made a marshal in the Portuguese army. III 3, John George Beresford (1773-1862), primate of all Ireland. III 4, George Thomas Beresford (1781-1839), a privy councillor. III 6 (F F) Henry de la Poer Beresford, second Marquis of Waterford (1772-1826), a privy councillor. III 7 (F M), Lady Susanna Carpenter, a singularly beautiful woman. III 8 (M F), Charles Powell-Leslie.

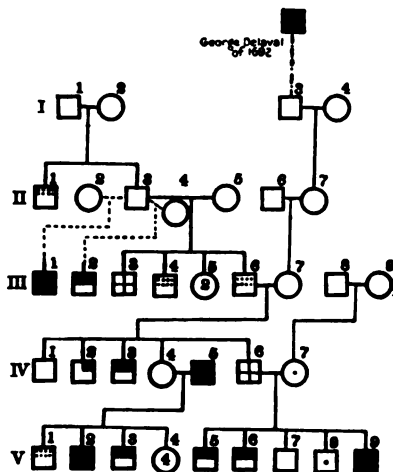

*Fraternity of F:* IV 1, Henry de la Poer Beresford, third Marquis (1811-1859), was killed in the hunting field. IV 2, William Beresford (1812-1850), of the First Life Guards. IV 3, James Beresford (1816-1841), an officer in the army. IV 4, Sarah Elizabeth Beresford. IV 5, Henry John Talbot, eighteenth Earl of Shrewsbury (1803-1869), an admiral of the Royal Navy. IV 6 (F), John de la Poer Beresford, fourth Marquis (1814-1866), in holy orders. IV 7 (M), Christina Powell-Leslie (1820-1905), a noted rider to hounds.

*Fraternity of Children of F's Sib:* V 1, Charles John Talbot, nineteenth Earl of Shrewsbury (1830-1877), lord high steward of Ireland. V 2, Walter (Talbot) Carpenter (1834-1904), an admiral of the Royal Navy. V 3, Sir Reginald Talbot (born 1841), a major-general in the army.

*Fraternity of Propositus:* V 5, John Henry de la Poer Beresford, fifth Marquis of Waterford (1844-1895), a captain in the army and master of the buckhounds. V 6, William Leslie de la Poer Beresford (1847-1900), V.C., a colonel in the army and military secretary to the governor-general of India. V 7, Marcus Beresford (born 1848), equerry to the king and manager of His Majesty's stud. V 8, Delaval James de la Poer Beresford (1862-1906), an army lieutenant and a rancher. V 9, (*Propositus*) CHARLES DE LA POER BERESFORD.

## BIBLIOGRAPHY.

- BERESFORD, C. 1914. *The Memoirs of Admiral Lord Charles Beresford*. Boston: Little, Brown, and Co. 2 vols.  
 BURKE, SIR B., and A. BURKE. 1909. *A Genealogical and Heraldic History of the Peerage and Baronetage*. London: Harrison and Son. 2570 pp.

## 6. GEORGE SMITH BLAKE.

GEORGE SMITH BLAKE was born at Worcester, Massachusetts, in 1802. He was appointed to the United States navy as midshipman in 1818 and assigned to the schooner *Alligator*. When, in 1821, the *Alligator* was attacked near the Cape Verde islands by a Portuguese ship, the latter was captured and Blake was sent back with her and a prize crew to the United States. After a few years of mercantile service, Blake was commissioned lieutenant, March 1827, and cruised in the West Indies after pirates. In 1835 he was appointed to the command of the schooner *Experiment*, in the United States Coast Survey, and charted many of the bays and inlets of the east coast of the United States. Blake was later for a time attached to the Philadelphia navy yard. In 1846 he was appointed to the command of the brig *Perry* in the Gulf squadron, which was wrecked on the Florida reefs in a gale. However, he got her off the rocks and with a temporary rudder and jury spars brought her to Philadelphia. In 1849 he was appointed to command the Mediterranean squadron; and after that he was for some years assigned to various ordnance and construction duties. In 1857 he was appointed superintendent of the Naval Academy and served until 1865. When the Civil War broke out sympathizers with the Confederacy tried to seize the frigate *Constitution* and the Naval Academy at Annapolis, but his prompt measures saved them, and the Academy was removed during the war to Newport, Rhode Island. He was prevailed upon to continue the superintendency during the war at the request of the Secretary of the Navy, Gideon Wells. He was commissioned commodore, July 1862, and after the war was made a lighthouse inspector. He wrote the lives of naval officers for the *New American Encyclopedia*. He died at Longwood, Massachusetts, June 24, 1871.

Few data are available relating to Blake's personality. A study of the pedigree chart shows clearly, however, that success in the navy comes easily to this family. Blake's father was at the head of the legal profession in Worcester, Massachusetts; he had a brother who was surgeon in the navy. George S. Blake's mother was Elizabeth A. Chandler, of a distinguished conservative (Loyalist) family of Worcester county, of whom some were eccentric. A sister of George

Blake had a son, who assumed the name Charles Follen Blake, was lieutenant commander on the *Brooklyn* in the battle of Mobile Bay, and "fought his gun nobly and well," according to his captain. George Blake married a daughter of Commodore James Barron, and their son, Francis Barron Blake, graduated from the United States Naval Academy, 1857, was active and gallant in naval undertakings of the Civil War, was made lieutenant commander in 1863, and resigned in 1870 to enter business. He was a banker in 1881.

FAMILY HISTORY OF GEORGE SMITH BLAKE.

I 1 (M F F F), John Chandler (born New London, Connecticut, 1693), came of the most distinguished and influential family in Worcester county, Massachusetts, for nearly half a century. He was a surveyor and held many important town offices. I 2 (M F F M), Hannah Gardiner.

II 1, Dorothy Paine. II 2 (M F F), John Chandler (born New London, Connecticut, 1720), held many town offices, and was judge of probate; a Loyalist who died in London in 1800. II 3 (M F M), Mary Church. II 4, Samuel Bancroft (born 1715), is referred to as a "wise counselor and an able speaker"; was selectman and representative. II 5, Lydia Parker, born 1716.

*Half Fraternity of M F:* III 1, John Chandler (born 1742), was a successful merchant who in later life became melancholy and hanged himself. III 2, Gardiner Chandler, born and died 1743. III 3, Clark Chandler (1743-1804), was joint register of probate and was considered odd. III 4, Dorothy Chandler (1745-1818). III 5 (M F), Gardiner Chandler (born 1749), was a justice of the peace; a Loyalist. III 6 (M M), Elizabeth Ruggles. *Fraternity of M F:* III 7, Rufus Chandler (born 1747), after being graduated from Harvard College, became an influential lawyer; a Loyalist. III 8, Nathaniel Chandler (born 1750), also was graduated at Harvard and became a lawyer. As a Loyalist he commanded a volunteer corps. III 9, William Chandler (1752-1793), was graduated at Harvard; a Loyalist. III 10, Charles Chandler (born 1755), a merchant. III 11, Samuel Chandler (1757-1813), was educated at Harvard; a manufacturer; one of the committee to confer on the commercial treaty with Great Britain. III 12, Sarah (1758-1819), Mary (born 1759), and Elizabeth (1722-1820) Chandler. III 13, Benjamin

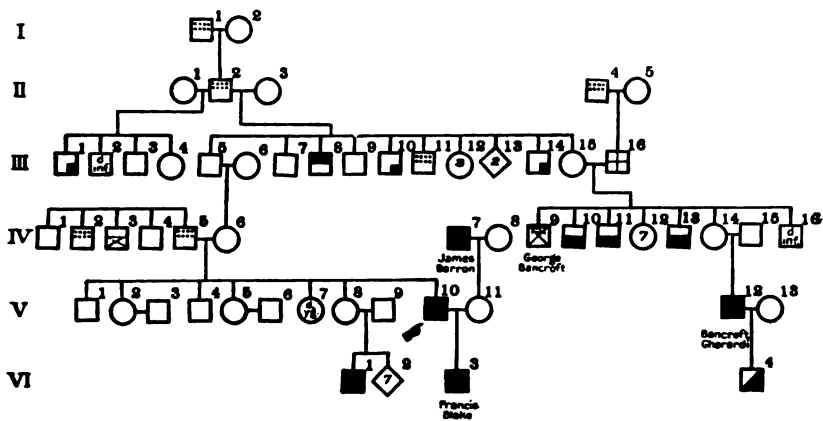

and Frances Chandler, drowned at an early age. III 14, Thomas Chandler, was graduated at Harvard and became a merchant. III 15, Lucretia Chandler (1765-1839), a woman of great conversational powers and ardent social feelings. III 6, Aaron Bancroft (born 1755), a pioneer Unitarian preacher.

*Fraternity of F:* IV 1, John Blake. IV 2, George Blake (born 1769), after having been graduated at Harvard College, took a high place in legal and political affairs. He was United States district attorney for Massachusetts, served in both houses of the State legislature, and was the first Democratic candidate for mayor of Boston. IV 3, Charles Blake, was educated at Harvard Medical School and became a surgeon in the navy and later in the army. He was wounded on board the *Constitution*. IV 4, Joshua Blake. IV 5 (F), Francis Blake, was gradu-

ated from Harvard College in 1789. He rose to the head of the law profession in Worcester and became a member of the State senate: he died in 1817. IV 6 (M), Elizabeth Augusta Chandler. IV 7 (Consort's F), James Barron, of Virginia (1769-1851), came of well-known naval stock, and became a sailor in his youth. He was in command of the *Chesapeake* when she was boarded by officers from the *Leopard* (1807) and he was suspended from the navy for five years for setting out for sea unprepared. IV 9, George Bancroft (born 1800), was appointed secretary of the navy and was instrumental in establishing the Naval Academy at Annapolis; he also acted as secretary of war; was United States minister to England, to Prussia, and the German Empire. He is noted as a historian. IV 10, Henry Bancroft (1787-1817), was an East Indian captain and was in command of one of Commodore MacDonough's ships on Lake Champlain in 1814. IV 11, John Bancroft (1789-1821), an East Indian captain. IV 13, Thomas Bancroft (born 1877), was a seafaring man. IV 14, Jane Putnam Bancroft (1798-1839). IV 15, Donati Gherardi, a teacher of Italian in the Round Hill School, Northampton, Massachusetts. IV 16, Charles Bancroft, born and died in 1805.

*Fraternity of Propositus*: V 1, Francis Arthur Blake (1796-1814), was a graduate of Harvard College (1814). V 2, Juliana Blake. V 3, Charles C. Tucker. V 4, Joseph Gardiner Blake (born 1800). V 5, Charlotte Caldwell Blake (born 1804). V 6, Rev. Thomas R. Sullivan. V 7, Elizabeth Blake (1806-1810). V 8, Dorothea Ward Blake. V 9, Oliver Hunter Blood. V 10 (*Propositus*) GEORGE SMITH BLAKE. V 11 (consort), Mary Allen Barron. V 12, Bancroft Gherardi (born 1832), rose to the rank of a rear admiral in the United States navy.

VI 1, Charles Follen Blood, changed his name to C. F. Blake. After being graduated from the United States Naval Academy in 1861, he was appointed a lieutenant; and, in 1866, was lieutenant commander on the *Brooklyn*. *Child of Propositus*: VI 3, Francis Barron Blake (born 1837), was graduated from the United States Naval Academy in 1857, and in 1861 was appointed a lieutenant on board the frigate *Colorado*. He helped destroy the privateer *Judith*, while she was moored at Pensacola under the guns of the navy yard. Later he was attached to the steamer *Kennebec* and was on her during her attempted passage of Forts St. Philip and Jackson, April 24, 1862. He rose to the rank of lieutenant commander in 1863, but resigned in 1870, when he became a banker. VI 4, Walter Gherardi, a lieutenant in the United States navy.

#### BIBLIOGRAPHY.

- BLAKE, F. 1871. *Memoir of George Smith Blake*. Cambridge University Press. 25 pp.  
 CHANDLER, G. 1883. *The Chandler family*. Worcester: C. Hamilton. vi (2) 1315 pp.  
 DWIGHT, B. 1874. *The History of the Descendants of John Dwight*. New York: J. Trow and Son. 2 vols. in 1. xxix + 1144 pp.  
 SOMERBY, H. 1881. *Record of Blakes of Somersetshire, especially in the line of William Blake of Dorchester, Massachusetts*. Boston: Privately printed; 64 pp.  
 STURGIS, MRS. E. 1904. *Sketch of the Chandler Family in Worcester, Massachusetts*. Worcester: Press of C. Hamilton. 33 pp.

## 7. ROBERT BLAKE.

ROBERT BLAKE was born at Bridgewater, in Somersetshire, September 1599. He was well educated and had a taste for literature. He entered Oxford at 16 years of age, was assiduous in books, lectures, and devotions, and liked fishing and shooting. His course at the university was impaired by his reputation for Puritan leanings and by his short stature, against which one of the officials had a prejudice. At 27 his father died and Robert abandoned his scholarly ambitions to pay his father's debts. Having now become a pronounced Puritan, Blake ran for Parliament (1640), and when war broke out with the King's party, in 1642, he served with the parliamentary forces under Sir John Horner. He resisted Royalist forces in southwestern England and reentered Parliament from Taunton in 1645. In 1649 he was appointed, with two others, to the command of the fleet. He fought three great campaigns. The first was against the royalist fleet under Prince Rupert. This fleet had entered the harbor of Kinsale, Ireland, and there Blake blockaded it. Reduced to desperation, Rupert's fleet tried, successfully, to break the blockade, and Blake followed it to the Tagus river and blockaded it there. Since the King of Portugal refused Blake's demand for permission to attack the enemy, Blake fell on the Portuguese merchant fleet returning from Brazil and captured seven ships as prizes, burning three. Prince Rupert's fleet, denied further refuge at the Tagus, fled to the Mediterranean, and here, in 1650, near Cartagena, Blake destroyed the greater part of it.

The second campaign began in 1652 with the declaration of war against the Dutch. In May Tromp's fleet of 45 ships met Blake's of 20 ships off Dover, and the Dutch, having lost 2 ships, withdrew at night. Blake captured a large part of the Dutch fishing fleet and drove off the Dutch fleet under De Ruyter and De Witt. Again the Dutch fleet appeared under Tromp, and this time Blake was defeated and forced to take refuge in the Thames. He fought against the Dutch fleet twice more, driving them off.

The third campaign was in the south, against the Moors and the Spanish. The former were forced to cease their piratical attacks on the British, and when Tunis resisted its two fortresses were destroyed. Learning that the Plate fleet of Spain lay at anchor in the bay of Santa Cruz, Teneriffe, Blake proceeded there and reduced the castle and forts and burned the ships, losing only one of his own. The Spaniards declared that they had to fight against devils and not men. At this time a new principle was established, that naval vessels might be effective against castles and land fortifications. Blake died in 1657.

Robert Blake was simple in tastes and habits, dignified and refined. A pure patriot, frank, generous, sincere, modest, magnanimous. He was blunt in speech and had a sense of humor.

Robert Blake was one of a famous fraternity. Humphrey, born in 1600, was tried for nonconformity and fled to Carolina; later, he was in Robert's fleet, but the latter felt he did not do his duty at Teneriffe and sent him home in disgrace. William, born in 1603, became a learned man, a doctor of laws of the University of Padua. George became a goldsmith and banker. Samuel was a farmer, joined with his brothers in the English Civil War, and was killed; his son Robert served in his uncle's fleet. Nicholas, like his father and grandfather, engaged in Spanish trade. Benjamin went to sea and became captain in the navy. Alexander was probably farmer.

The father of this fraternity was Humphrey Blake, who was a merchant engaged in Spanish trade. He used to go to sea on his own vessels and would eat and sleep on deck. He had many tales to tell his children of pirates. Although once rich, he lost much money in later life. His father, Robert Blake, was also a merchant in Spanish trade. He was thrice magistrate of his town of Bridgewater and left it by will £240 for the poor and for highways.

In Robert Blake's fraternity some individuals are characterized by great learning, others by finance and thrift and mercantile life, others by domesticity, and others by nomadism and love of the sea. Robert was a scholar, but also a reformer and a fighter. Certain traits of refinement and dignity doubtless come from the paternal side. Lack of knowledge about the maternal side prevents us from deriving the origin of other traits.

FAMILY HISTORY OF ROBERT BLAKE.

I 1 (F F) Robert Blake, a merchant in the Spanish trade, and thrice chief magistrate of Bridgewater. I 2 (F M), Margaret Symonds. I 3 (M F), Humphrey Williams, master of Plainfield, Somersetshire.

II 1 (F), Humphrey Blake, a merchant in the Spanish trade, who manned his own ships in the Moorish pirate days. II 2 (M), Sara Williams, an heiress.

*Fraternity of Propositus:* III 1, Humphrey Blake, at one time captain of a ship-of-war; non-conformist. III 2, William Blake, a learned man.

III 3, George Blake, a banker. III 5, Samuel Blake, a farmer and fighter. III 6, Nicholas Blake, in the Spanish trade. III 7, Edward, Benjamin, and John Blake. III 8, Benjamin Blake, a captain in the navy. III 9, Alexander Blake. III 11 (*Propositus*), ROBERT BLAKE.

IV 1, Benjamin Blake, who had a taste for letters.

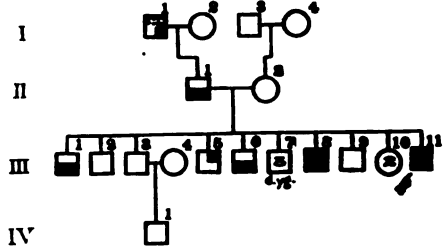

BIBLIOGRAPHY.

DIXON, H. 1852. Robert Blake, Admiral and General at Sea. London: Chapman and Hall.

## 8. JAHLEEL BRENTON.

JAHLEEL BRENTON was born August 22, 1770, in Rhode Island. He removed to England with his Loyalist father in 1780. In 1781 he embarked as midshipman in the armed *Queen*, of which his father was then commander, and in 1783-1785 he spent two years in a maritime school at Chelsea. In March 1790 he passed his examination for lieutenant and, seeing no chance for active service in England, enlisted in the Swedish navy against the Russians in the gulf of Finland, returning to England in November of the same year. During the next ten years he won distinction in minor actions. His most brilliant success was fought with a flotilla of Franco-Neapolitan vessels outside of Naples in May 1801. Here he was severely wounded. Thenceforth, unable to bear sea service, he did shore service and took an active part in philanthropic work in association with his brother, Captain Edward P. Brenton, a writer on naval and military history.

Thalassophilia is a family trait. The propositus went to sea at the age of 11 years. His two brothers and their father were all naval officers, respectively lieutenant at the time when killed in action, captain, and rear admiral in the British navy. Jahleel's son Jervis "from his infancy expressed a wish to follow" his father's profession "and had appeared confirmed in the resolution"; he went to sea with his father at the age of 11 years; but this son died at 16 years. The propositus, after being wounded, explored (in 1817) the country to the north of the Knyszna, in South Africa.

Brenton was a good administrator. With his brother Edward he organized a reformatory for juvenile delinquents. Their great-great-grandfather, William Brenton, was governor of Rhode Island and Providence Plantations (1666-1669). William Brenton's sons held important positions in the colony.

There is evidently conservatism rather than radicalism; calmness under disappointment; capacity for enduring hardships; firmness and self-reliance. "His taste so refined, his manners so gentle, his kindness so constant, that much of what the world calls goodness seemed to grow up in him spontaneously and cost him nothing. He was amiable without an effort, benevolent without reflection, and habitually thinking more of others than himself." Such a man would naturally take an interest in reforms. Probably it was this same conservatism which was in his father and led him to refuse the proffers of high rank in the colonial navy and to abandon his property in America rather than his allegiance to his king.

It appears that Jahleel was an artist also, and as a youth seriously considered becoming a painter, especially of landscapes, for scenery always awakened an esthetic sense in him.

## FAMILY HISTORY OF SIR JAHLEEL BRENTON.

I 1 (F F F F), William Brenton, settled as a merchant in Boston in 1634, and was the following year chosen a deputy of the general court. Later he removed to Rhode Island, of which colony he was, in 1667-1668, governor. He died in 1674. I 2 (F F F M), Mary Burton. I 3 (F M F F), John Cranston, born in England about 1620, came to Rhode Island and was appointed major and given command of the militia during King Philip's war. He served as deputy governor and, in 1678, was elected governor, serving till his death in 1680. I 4 (F M F M), Mary Clarke. I 5, Walter Clarke (1640-1714), was colonial governor of Rhode Island in 1676-1677, 1686, 1696-1698, and frequently acted as deputy governor.

*Fraternity of F F F*: II 1, Sarah Brenton. II 2, Joseph Eliot (see Foote family). II 3, Ebenezer Brenton. II 4, Jahleel Brenton, collector, surveyor, and searcher of the customs within the colonies of New England. II 6 (F F F), William Brenton. II 7 (F F M), Martha

Church. II 8 (F M F), Samuel Cranston (1659-1727), after his marriage went to sea and was captured by pirates. He held the military office of major for the islands of the colony and in 1698 succeeded his uncle as governor, remaining in office till his death. With him "the Quaker régime went out and that of 'the world' came in."

*Fraternity of F F*: III 1, Ebeneser and Benjamin Brenton. III 2 (F F), Jahleel Brenton. III 3 (F M), Frances Cranston. III 4 (M F), Joseph Cowley, formerly of England. III 5 (M M), Penelope Pelham.

IV 3 (F), Jahleel Brenton (1729-1802), very early in life entered the navy, and at the outbreak of the Revolution, although he was but a lieutenant, he was offered the highest naval rank that the Congress could give. But he left Rhode Island secretly and joined his majesty's forces, rising to the rank of admiral. IV 4 (M), Henrietta Cowley. IV 5, James Brenton (a relative), a judge of Halifax, Nova Scotia.

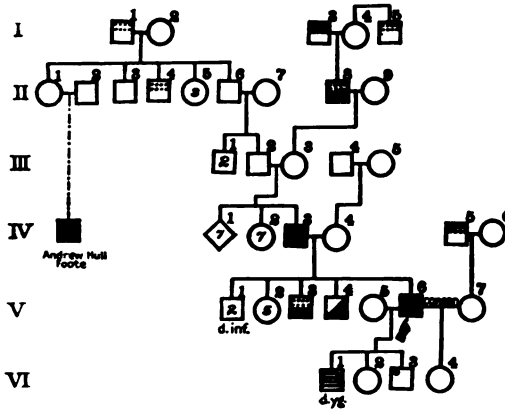

*Fraternity of Propositus*: V 3, Edward Pelham Brenton (1774-1839), followed the sea and held the rank of captain in the Royal Navy. In later years he was much interested in establishing a reformatory for juvenile delinquents; he was author of a naval history of Great Britain. V 4, James Wallis Brenton, was in the British navy and was killed in action when first lieutenant of H. M. S. *Petrel*, in command of a boat expedition in chase of an enemy's vessel near Barcelona. V 5 (first consort), Isabella Stewart, of Annapolis, Maryland (1771-1817). V 6 (*Propositus*) SIR JAHLEEL BRENTON. V 7 (second consort), Harriet Brenton.

*Children of Propositus*: VI 1, John Jervis Brenton (1803-1817), accompanied his father upon a voyage in 1812 as "he had from infancy expressed a wish to follow his father's profession." VI 2, Isabella Brenton, born 1806. VI 3, Sir Launcelot Charles Lee Brenton (born 1806), was a landsman; he had no artistic taste; was a nonconformist, a scholar, and a critic. He edited his father's "Life." VI 4, Harriet Mary Brenton, born 1823.

#### BIBLIOGRAPHY.

- RAIKES, H. 1860. *Memoir of Vice-Admiral Sir Jahleel Brenton*. Ed. by C. Brenton. London: Longman and Co. cxxxv + 521 pp.
- BRENTON, E. P. 1825. *The Naval History of Great Britain*. London: C. Rice. 5 vols.



## 9. MOSES BROWN.

MOSES BROWN was born at Salisbury, Massachusetts, January 23, 1742. He received a limited education and at 15 years of age was apprenticed to Captain William Coffin, of a merchant vessel. Thereafter his life was, he says, "a single, continuous, uninterrupted voyage." In his second year at sea Captain Coffin intrusted him to sell Coffin's schooner *Sea Flower* in the West Indies, and the next year the *Sea Nymph* at St. Christopher's. During 1761, in the schooner *Phæbe*, he fought two French privateers and was shot in the arm. He continued his mercantile voyages until the outbreak of the Revolutionary war, when, being found in Venice, he made a pretended sale of his ship, loaded her with currants for London, and sold her there for £800. Sailing for the Dutch West Indies, he made his way eventually to Philadelphia and overland to New York, where he offered his services to the navy. He sailed for the West Indies in April 1777, in command of the brig *Hannah*, but he was captured by the British and put in a prison-ship in Rhode Island. After being exchanged, he was given command (in August 1777) of the cruiser *General Arnold*. He had various adventures. His crew conspired to kill him and take the ship to Halifax, but failed. In trying out the guns one burst and killed and injured several men. He fought against the British ship *Gregson*, of double his strength. The English lost 18 men in the battle, but the ship got away. On May 20 the English privateer *Nanny* was sunk by him and her captain sent to Cadiz, while Brown escaped in sight of eight British ships-of-the-line and frigates. Next he captured the *George*, but she was recaptured by the British, and a little later the *General Arnold* was captured by the English ship *Experiment*, 50-guns, and Captain Brown was placed aboard a prison-ship at Savannah, Georgia, from which he was exchanged in November. From 1780 to 1783 he commanded the privateer *Intrepid* and was instructed to bring dry goods from France, which he did. For the following fifteen years he was captain of various merchant craft. Owing to an extension of privateering, a national navy was established, and when the merchants of Newburyport built the *Merrimac* for the government, Captain Brown was placed in command of her and during the next three years captured four French vessels. Upon his inauguration Jefferson disposed of nearly half of the vessels of the navy, including the *Merrimac*, and Brown returned to merchant ships. He died of apoplexy at sea in 1804.

Brown was first of all a born sailor—a lover of the sea and doubtless a nomad. He was 47 years at sea and made 65 voyages, some of them two years long. He married Sarah Coffin, of Newburyport, doubtless of maritime stock, and his sons William and Joseph both made sea voyages. His son Moses (like William) was lost at sea.

Brown was a brave fighter, like his father who was in the French War. His courage is evinced in the anecdote that while a prisoner on the English ship *Experiment* he toasted George Washington. He was quietly religious like his mother (Dorothy Pike), was fond of children and enjoyed telling stories to them. He was known to his crew as "Gentleman Brown"; he maintained good discipline and had a good feeling for his crew; was averse to flogging and kept his ship neat and his men temperate.

## FAMILY HISTORY OF MOSES BROWN.

I 1 (F F), Edward Brown, died in 1737, aged 57. I 2 (F M), Sarah, died in 1737, aged 60 years. I 3 (M F), Timothy Pike, of Newbury, Massachusetts.

II 1 (F), Edward Brown (1707-1775), followed the trade of cooper in Salisbury; later he was deputy sheriff and had care of the prison in Newbury. During the French War he was a captain. II 2 (M), Dorothy Pike (1710-1790).

*Fraternity of Propositus:* III 1, Sarah Brown (1732-1817), was a pleasant, kind, amiable, and religious woman. III 2, Dorothy Brown (1733-1770). III 3, Susanna Brown (1735-1805), had a taste for reading; was of kindly disposition but somewhat depressed before her death. III 4, Edward Brown (1737-1815), followed the sea as a cooper from early life. In the old French War he was made a prisoner and confined on a prison-ship in the West Indies. From the age of 20 he suffered from a sort of chorea. He also exhibited marked phobias and was very punctilious as to certain trivial or senseless performances. He was regarded as "bewitched." III 5, Esther Brown (1740-1824). III 6, Elisabeth Brown (1743-1791), a nurse. III 7, Mary Brown (1745-1746). III 8, Anne Greenough, died 1774. III 9, Nicholas Brown (1747-1819). III 10, Lucy Lamprey (born 1760). III 11, Mary Brown (1750-1834). III 12 (*Propositus*) Moses Brown. III 13 (consort), Sarah Coffin, of Newburyport.

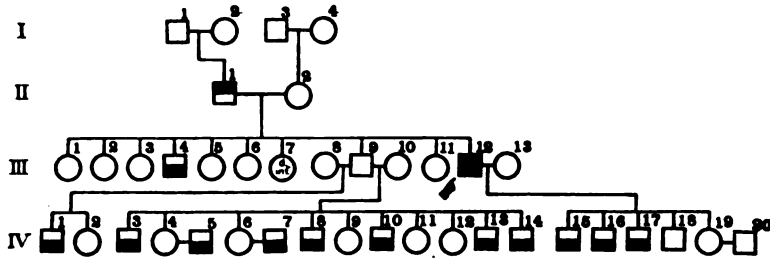

IV 1, Edward Brown (1771-1819), was a cooper and employed in the West India trade. Later he was a ferryman; then, inspector of provisions. IV 2, Ann Greenough Brown (born 1773). IV 3, Moses Brown, born 1778 and lost at sea, 1818. IV 4, Anne Brown, born 1782. IV 5, Alexander McCulloch, a sailing-master of the United States navy. IV 6, Abigail Brown (born 1788). IV 7, Eliphalet Woodbury, a seaman. IV 8, Nathan Brown (born 1795), a shipmaster. IV 9, Lucy Brown, born 1792. IV 10, Lawrence Brown (1790-1824), a shipmaster who died at sea. IV 11, Ruth Brown (1799-1807). IV 12, Dorothy Brown, born 1797. IV 13, John Brown (1802-1825), a shipmaster, lost at sea. IV 14, Nicholas Brown (born 1784), a shipmaster. *Children of Propositus:* IV 15, William Brown, became a shipmaster and was lost at sea in 1799. IV 16, Moses Brown, a shipmaster who was drowned in 1797. IV 17, Joseph Brown (born 1774), went on his first voyage as a cooper, sailing with his father to South America in 1794. IV 18, James Brown. IV 19, Sarah Brown. IV 20, David Reed.

## BIBLIOGRAPHY.

- MACLAY, E. S. 1904. Moses Brown, captain United States navy. New York: The Baker and Taylor Co. 220 pp.
- TENNEY, S. 1913. Genealogical Data concerning the family of Captain Edward Brown of Newbury, Massachusetts. Millis, Massachusetts: W. Tenney. 3 pp.

## 10. FRANKLIN BUCHANAN.

FRANKLIN BUCHANAN was born at Baltimore, Maryland, September 17, 1800. He was appointed midshipman in the navy January 1815, lieutenant in 1825, and master commandant in 1841. He organized and was the first superintendent of the Naval Academy at Annapolis, serving until 1847; he participated in the capture of Vera Cruz and commanded the *Susquehanna*, flagship of Perry's fleet, on the expedition to Japan. Made captain in 1855, he was assigned to the command of the navy yard at Washington in 1859. In April 1861, believing that Maryland was about to secede, he resigned, but when he found that the State was to remain in the Union he desired to withdraw his resignation, but was not reinstated. So, in September 1861, he entered the Confederate navy as captain. He superintended the construction of the ram *Merrimac* and commanded her in her destructive work in Hampton Roads, but, as he was wounded, he could not command her against the *Monitor*, a few days later. In 1863 he was given command of the naval defenses of Mobile and built the ram *Tennessee*. He commanded her against Farragut's fleet, August 5, 1864, was compelled to surrender and was taken prisoner. After the war he was president of the Maryland Agricultural College and agent for a life-insurance company. He died in 1874.

Of his fraternity there is McKean Buchanan, who, after two years at the University of Pennsylvania, went into mercantile life, became a warrant clerk in the Navy Department, and in 1826 was commissioned purser (later paymaster) in the navy. He was in the first American man-of-war that cruised around the world; seven times he rounded Cape Horn and once went around the Cape of Good Hope. He gained the rank of commodore. He was very agreeable, prompt, accurate, and responsible. Another brother, George, was a farmer all his life; he married Sarah G. Miles, daughter of Evan Miles, and both of their sons, who grew up, were killed in action during the Civil War; one as captain in the army and one as a lieutenant commander on the *Mississippi*. A sister, Mary Ann, born in 1792, married Edward J. Coale, in the diplomatic service, and one of their sons was assistant surgeon in the navy.

Franklin Buchanan married Ann Lloyd, daughter of Governor Edward Lloyd of Maryland, a gentleman of wealth. Buchanan's only son, Franklin (born in 1827), was the largest rice-broker in Savannah. The latter's sister, Elizabeth, had a son, Franklin Buchanan Sullivan, born in 1871, who was appointed a naval cadet at large and was the youngest member of his class at Annapolis, being under 15 years of age on admission.

Franklin Buchanan's father was George Buchanan, a physician, whose father was a brigadier general of the Maryland troops. Franklin's mother was a daughter of Thomas McKean, one of the original revolutionists of Delaware, who, with two others, drew up the address to the House of Commons and boldly denounced the chairman when he refused to sign it. He was active on committees, promoted the Declaration of Independence, and signed it. Then he led a force, of which he was colonel, to General Washington at Perth Amboy, New Jersey, and took part in several skirmishes. Returning, he framed a constitution for Delaware in a single night and under it became president of the State in 1777. From 1777 to 1799 he was chief justice of Pennsylvania and from 1799 to 1808 was governor of that State. He died in 1817. Letitia McKean's mother's father, Joseph Borden (born in 1719), was not less notable. He was a member of the first revolutionary convention that met at New Brunswick, July 1774, and was active in the inner circles until war broke out, when he became a colonel of the

Burlington militia and fought in most of the battles on New Jersey soil. His son Joseph was a gallant cavalryman and quartermaster in the Revolutionary war. Another daughter of Thomas McKean (besides Letitia) was Anne, who married Andrew Buchanan, brother of Franklin Buchanan's father. They had a son, Thomas McKean Buchanan, who became a lieutenant in the navy in 1827. He had a sister, Anne, who married Colonel Richard Wade and had a son, Robert Buchanan Wade, a captain in the United States army and professor of military science in Missouri State College. A son of Thomas McKean, the signer, was Joseph Borden McKean, who became an associate judge of the district court of Philadelphia, and had a son, William Wister McKean, who became a commodore in command of a part of the Gulf Squadron.

Thus Franklin Buchanan's family abounded in administrative, legislative, and fighting capacities, and in an attachment to the sea.

#### FAMILY HISTORY OF FRANKLIN BUCHANAN.

I 1 (F F F) George Buchanan, born in Scotland about 1680; in 1723 came to Maryland, where he practiced medicine. In 1729 he was one of the commissioners to lay out the city of Baltimore; in 1749 he was elected a member of the general assembly of Maryland. I 2 (F F M), Eleanor Rogers, daughter of Nicholas Rogers. I 3 (M M F), Joseph Borden (1719-1791), in 1765

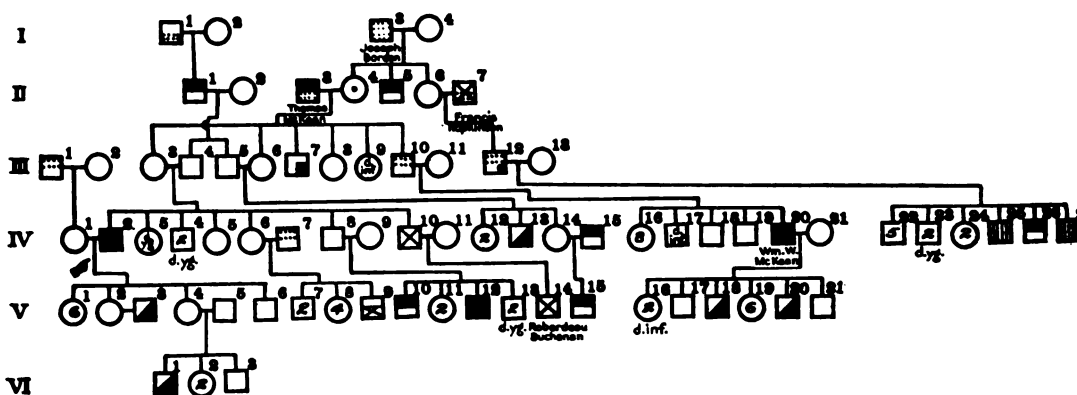

assumed entire control of the stage and boat line between Philadelphia and New York. He was a member of the committee of correspondence and, in February 1775, one of the committee of observation; a member of the Provincial Congress that met in Trenton; one of the committee of safety; was also a judge of the court of common pleas. He was a colonel of the First regiment of Burlington (New Jersey) militia and in 1776 was appointed quartermaster. I 4 (M M M), Elizabeth Watson (died 1807, aged 81 years), was the daughter of Marmaduke Watson.

II 1 (F F), Andrew Buchanan (1734-1786), a justice, became, in 1776, brigadier general of the Maryland state troops. He was also a member of the committee of correspondence in 1774 and of the committee of observation in 1775. II 2 (F M), Susan Lawson. II 3 (M F), Thomas McKean, of Scotch-Irish ancestry, was born in Chester county, Pennsylvania, in 1734. He became speaker of the general assembly of Delaware. He was a member of the Stamp Act Congress of 1765 and a member of the Continental Congress from 1774 to 1783, and signed the Declaration of Independence. II 4, Mary Borden. *Fraternity of M M*: II 5, Joseph Borden (1755-1788) was an ardent patriot who raised and commanded the Burlington (New Jersey) troop of light horse; he was also quartermaster of the militia. II 6, Ann Borden. II 7, Francis Hopkinson (1737-1791), a well-known statesman and jurist who signed the Declaration of Independence and was judge of the admiralty for Pennsylvania.

III 1 (consort's F), Edward Lloyd (1779-1834), governor of Maryland. III 2 (consort's M), Sallie Scott Murray. III 3 (M), Letitia McKean (1769-1845). III 4 (F), George Buchanan (1763-1808), took his medical degree in Philadelphia and practiced. *Fraternity of F*: III 5, Andrew Buchanan. *Fraternity of M*: III 6, Anne McKean (born in 1773). III 7, Robert McKean

(born 1766), a merchant in Philadelphia. III 8, Elizabeth McKean (born 1767). III 9, Mary McKean (born and died 1781). III 10, Joseph Borden McKean (1764-1845), a judge. III 11, Hannah Miles. III 12, Joseph Hopkinson (1770-1842), a prominent jurist of Philadelphia who is better remembered as the author of "Hail Columbia." III 13, Emily Mifflin, of Philadelphia.

IV 1 (consort), Ann Lloyd. IV 2 (*Propositus*), FRANKLIN BUCHANAN. *Fraternity of Propositus*: IV 3, Susanna Buchanan (1790-1795). IV 4, Thomas (born 1791) and Andrew Buchanan (1794-1796). IV 5, Rebecca Susan Buchanan (born 1793). IV 6, Mary Ann Buchanan (1792-1866). IV 7, Edward J. Coale, a lawyer who became consular agent of Russia for Maryland and vice consul of Brazil. IV 8, George Buchanan (born at Baltimore, 1796), after being graduated from the University of Pennsylvania, turned to agricultural pursuits. IV 9, Sarah G. Miles (1806-1844), daughter of Evan Miles. IV 10, McKean Buchanan (1798-1871), became pay director of the navy of the United States, with the rank of commodore. IV 11, F. Selina Roberdeau. IV 12, Susan (born 1798) and Mary Buchanan (born 1800). IV 13, Thomas McKean Buchanan (born 1802), was appointed a midshipman in the United States navy in 1818 and became a lieutenant in 1827; died unmarried. IV 14, Anne McKean Buchanan (born 1803). IV 15, Colonel Richard Wade, United States army. IV 16, Mary (born 1787), Catherine (born 1788), Elizabeth (born 1794), Ann (1796-1800), Letitia (1798-1800), Letitia (born 1802), Caroline (born 1805), and Adeline McKean (born 1809). IV 17, Thomas McKean (1791-1792). IV 18, Samuel McKean (born 1789), after being graduated from the University of Pennsylvania, became a clerk in the treasury department. IV 19, Joseph McKean (born 1792), a lawyer. IV 20, William Wister McKean (1800-1865), was appointed a midshipman in 1814; in 1821-1822 he was in command of the schooner *Alligator* in Porter's squadron and was active in suppressing piracy in the West Indies. In 1861 he had command of the Gulf squadron as flag officer. As commodore he was placed on the retired list in 1862. IV 21, Davis Rosa Clark, born 1806. IV 22, Thomas Mifflin, Francis (died 1870), George, James, and Joseph Hopkinson. IV 23, James and John Joseph Hopkinson. IV 24, Elizabeth and Emily Hopkinson. IV 25, Alexander Hamilton Hopkinson, entered the United States navy and died in 1827 in the Mediterranean. IV 26, Oliver Hopkinson, was a lieutenant colonel of the First Regiment Infantry, Delaware Volunteers, in the Civil War. IV 27, Edward C. Hopkinson, a midshipman in the United States navy, was killed when 17 years of age.

*Children of Propositus*: V 1, Sally Lloyd (born 1835), Letitia (born 1837), Alice L. (born 1839), Rosa (born 1840), and Ellen (born 1841) Buchanan. V 2, Nannie Buchanan (born 1841). V 3, Lieut. Julius Meiere, of the United States Marine Corps. V 4, Elizabeth Buchanan (born 1845). V 5, Felix R. Sullivan, an insurance agent. V 6, Franklin Buchanan (born 1847), was the largest rice broker in Savannah. V 9, William E. Coale, became an assistant surgeon in the navy in 1837. V 10, Evan Miles Buchanan (1834-1864), was educated as a civil engineer. In 1860 he accepted the position of captain's clerk offered him by his relative, Commodore McKean. On the outbreak of the war he was appointed military secretary to General McClellan. He was captain and commissary of subsistence, United States army, in March 1862, and then chief commissary of Third Division, Third Army Corps. In 1864 he was captured by guerillas and shot. V 11, Letitia (born 1835) and Mary (born 1844) Buchanan. V 12, Thomas McKean Buchanan (1837-1863), was graduated from the United States Naval Academy in 1855; rose to the rank of lieutenant commander in the navy of the United States, and was killed in action. V 13, George (1839-1859) and John Buchanan (1841-1842). V 14, Roberdeau Buchanan (born 1839), mathematician at the Nautical Almanac Office, United States Naval Observatory; a genealogist. V 15, Robert Buchanan Wade (born 1844), was appointed a cadet in July 1861 and rose to the rank of captain. He became professor of military science in Missouri State College, Columbia, Missouri. V 16, Mary and Elizabeth McKean. V 17, Joseph Borden McKean (born 1827), a farmer in Virginia. V 18, Franklin Buchanan McKean (1830-1853), entered the navy as a midshipman in September 1845, but resigned, May 1847. V 19, Caroline, Elizabeth (born 1836), Catherine, Mary (born 1843), Rosa, and Adeline McKean. V 20, William Buchanan McKean (born 1840), was commissioned in the United States Marine Corps in 1861 and was promoted to captain in 1869. V 21, Samuel McKean, a farmer.

*Children of children of Propositus*: VI 1, Franklin Buchanan Sullivan (born 1871). VI 2, Mary and Nannie Sullivan. VI 3, Felix Sullivan (born 1874).

## BIBLIOGRAPHY.

- MCKEAN, C. 1902. McKean Genealogies. Des Moines: Kenyon Printing & Mfg. Co. 213 pp.  
 SCHARF, J. 1874. The Chronicles of Baltimore. Baltimore: Turnbull Bros. viii + 756 pp.  
 WOODWARD, E., and J. HAGEMAN. 1883. History of Burlington and Mercer Counties, New Jersey. Philadelphia: Everts and Peck. 888 pp.

## 11. THOMAS COCHRANE.

THOMAS COCHRANE (tenth Earl of Dundonald) was born at Annsfield, in Lanarkshire, December 14, 1775. Provided with a commission, he entered the infantry service, although he had been put on the books of a man-of-war while still a boy. He disliked military life and in 1793 went to sea in the ship of which his father's brother was captain. He became a lieutenant in 1796 and was court-martialed on account of a quarrel with a superior officer. Placed in command of a brig in 1800, "he gained a great and deserved reputation as a daring and skillful officer." He captured a Spanish frigate in 1801, by an act of unparalleled audacity. Having secured an election to Parliament, "he soon made his mark as a radical and as a denouncer of naval abuses." Engaged in an attack on the French squadron, April 1809, under Lord Gambier, his own work was brilliant, but he brought on a court-martial of the admiral which led to nothing but his own discomfiture. Meanwhile, he plunged into politics and speculations on the stock exchange and was dragged down by the speculations of an uncle and imprisoned. In 1817, on the invitation of the Chilean government, he commanded its naval forces against Spain and captured a Spanish frigate by an act of daring. In 1823 he helped Brazil in similar fashion to independence, but by 1825 he had fallen out with the Brazilians and returned to Europe. He then helped the Greeks for a time in their struggles with the Turks. Except for a command of three years at North American and West Indian stations (1848 to 1851) and certain relations with the Crimean War, he spent the last twenty-five years of his life in experiments and invention. He took out patents for lamps to burn oil of tar (his father was a pioneer inventor in the field of illuminating gas), for the propulsion of ships at sea, for facilitating excavation, mining, and sinking, and for rotary steam-engines. By 1843 he was advocating the use of steam and the screw propeller in warships. He died in October 1860, and was buried in Westminster Abbey.

Lord Dundonald was a hyperkinetic. He possessed abnormal restlessness, insatiable energy, and "a passionate though unconscious egotism." He was always self-assertive, frequently insolent to his superiors, daring as a naval officer, "saturated with the sense of his superiority, impatient of all control." "Never was a man more emphatically a man of action. Action was the breath of his nostrils. Give him an enemy to overcome and he was in his element; force him to concentrate his whole activity on that enemy and he was safe." "His whole life was made up of a series of quarrels." "To his combative nature, rejoicing in its strength, a new enemy can hardly be said to have been unwelcome."

This hyperkinesis is also shown in his father, who entered the army at the age of 16, but turned to the navy and became acting lieutenant. Ever restless, he left the navy and turned to physical and chemical experimentation, but in this he showed lack of balance. He established manufactories where the result of his researches could be practically applied, but, as these failed to bring a return, he plunged deeper and deeper into his manufacturing speculations. This father had a brother who was a colonel in the army, but threw up the service in disgust and became a member of Parliament. The father's father and father's father's father of the propositus were military men, but details as to their temperament and that of their consorts are lacking. One generation further back is John Cochrane, who was implicated in the Rye House plot in 1683, and was compelled to flee for his life to Holland. Two years later he returned to enter into the insurrection of Argyll. He was always turbulent and dissatisfied.

Dundonald had great inventive capacity, like his father; but, like him, too, he did not have pertinacity enough to follow up and improve upon his inventions. He was suspicious by nature. This was the basis of most of his quarrels. As he grew older this grew into a veritable paranoia; he maintained that he had been shamefully ill-treated by his son. "So loudly and openly did he complain of these imaginary injuries that Cochrane [his son] was compelled to contradict his statements by advertisements in the newspapers." The earl's autobiography is largely the story of a grievance.



FAMILY HISTORY OF THOMAS COCHRANE, EARL DUNDONALD.

I 1 (F F F F F F), Alexander Blair, took the name of Cochrane. I 2 (F F F F F M), Elisabeth Cochrane.

*Fraternity of F F F F F:* II 1, Sir John Cochrane, a colonel in the army of Charles I. II 3. Four other Cochranes were fighting men in the service of Charles I. II 5 (F F F F F), Sir William Cochrane, first Earl Dundonald. II 6 (F F F F M), Eupheme Scott.

*Fraternity of F F F F:* III 1, William, Lord Cochrane. III 2 (F F F F), Sir John Cochrane, in 1683 was implicated in the Rye House plot and was compelled to flee to Holland; two years later he returned to enter into the insurrection of Argyll, and was ordered to be hanged, but his father secured his release. III 2 (F F F M), Margaret Strickland.

IV 1 (F F F), William Cochrane. IV 2 (F F M), Lady Mary Bruce.

V 3 (F F), Thomas Cochrane, eighth Earl of Dundonald (died 1778), entered the army early, but retired with the rank of major. V 4 (F M), Jane Stuart (died 1808). V 5, Captain James Gilchrist, of the Royal Navy.

*Fraternity of F:* VI 2, Charles Cochrane (1749-1781), a colonel in the army and aide-de-camp to Lord Cornwallis, was killed at Yorktown in 1781. VI 3, John Cochrane, deputy commissioner to the forces in North America. VI 4, James Cochrane (1751-1823), vicar of Mansfield. VI 5, Basil Cochrane (1753-1826), a civil servant of the East India Company. VI 6, Sir Alexander Forrester Cochrane (1758-1832), a distinguished admiral of the blue. VI 7, Maria Shaw. VI 8, George Augustus Cochrane (born 1762), a lieutenant colonel in the army. VI 9,

Andrew Cochrane-Johnstone (1767-1834), a colonel in the army; became a member of Parliament. VI 10, Elizabeth Cochrane. VI 11 (F), Archibald Cochrane, ninth Earl of Dundonald (1748-1831), at 16 years of age a cornet in the Third Dragoons, later turned to the navy, but grew weary of this life, for his bent "lay towards natural science." VI 12, Anne Gilchrist.

VII 1, John E. Cornwallis Rous, second Earl of Stradbroke (1794-1886), served in the army with distinction, winning a medal with five clasps. VII 2, Augusta Musgrave. VII 3, Charles and Andrew Cochrane. VII 4, Sir Thomas John Cochrane (1789-1872), G. C. B. and admiral of the fleet. VII 5, Rosetta Cuffe. VII 6, Anna Maria and Jane Cochrane. *Fraternity of Propositus*: VII 7, Basil Cochrane (died 1816), a lieutenant colonel in the army. VII 8, William Erskine Cochrane (died 1871), a major, Fifteenth Hussars; served in Peninsular war. VII 9, Mary Anne Manson. VII 10, Edward Fitzgerald, a lieutenant colonel. VII 12, Archibald Cochrane (1783-1829), a captain of the Royal Navy. VII 13, Hannah Jane Mowbray. VII 14 (*Propositus*), THOMAS COCHRANE, tenth Earl of Dundonald. VII 15 (consort), Katherine Frances Corbet Barnes.

VIII 1, George Edward Rous, third Earl of Stradbroke (born 1862), vice admiral of Suffolk. VIII 3, Adela Rous. VIII 4, Sir Thomas Belhaven Cochrane (born 1856), admiral of the fleet. VIII 5, Francis Arthur Charles Cochrane. VIII 6, Rosetta and Annette Cochrane. VIII 7, William Marshall Cochrane (1817-1898), a colonel in the army. VIII 8, Mary Hussey. VIII 9, John Owen, captain Royal Navy. VIII 11, Sally C. Fitzgerald. VIII 12, Basil Edward Arthur Cochrane (1817-1895). VIII 13, Robert Cochrane (1816-1907). VIII 14, Archibald H. (1819-1907), and Arthur (born 1826) Cochrane. *Children of Propositus*: VIII 16, Thomas Cochrane, eleventh Earl of Dundonald (1814-1885), a captain in the army. VIII 17, Louisa Mackinnon. VIII 18, William Horatio Cochrane (1818-1900), in the army. VIII 19, Sir Arthur A. L. P. Cochrane (1824-1905), an admiral of the Royal Navy who distinguished himself at Acre; commanded the *Niger*, and was wounded at the destruction of the Chinese fleet, 1857. VIII 20, Ernest Grey L. Cochrane (born 1834), a captain of the Royal Navy, retired and became high sheriff of Donegal. VIII 21, Elizabeth K. Cochrane (died 1868). VIII 22, George Boyle, sixth Earl of Glasgow (1825-1890), Lord Clerk Register of Scotland. VIII 23, Hon. Montagu Cromby.

IX 1, Thomas B. H. Cochrane (born 1856), a lieutenant of the Royal Navy. IX 2, William Francis Cochrane (born 1847), a colonel in the army. IX 3, Thomas Erskine Cochrane (1849-1906), a commander of the Royal Navy. IX 4, John Palmer Cochrane (born 1852), a captain in the army. IX 5, Arthur H. D. Cochrane (born 1856). IX 6, Caroline Katherine and Edith Hamilton Cochrane. IX 7, Cornelia Ramsay Owen. IX 8, Basil Edward Cochrane (born 1841), a vice admiral of the Royal Navy. *Children's children of Propositus*: IX 12, Douglas Mackinnon Baillie Hamilton Cochrane, twelfth Earl of Dundonald (born 1852), a distinguished cavalry officer who became a lieutenant general in 1907. IX 14, Thomas Horatio A. E. Cochrane (born 1857), served in the army in South Africa; was under secretary of state for the home department. IX 15, Lady Gertrude Boyle.

X 1, Archibald Cochrane (born 1874), a commander of the Royal Navy. X 2, Edward Owen Cochrane (born 1881), a lieutenant of the Royal Navy. X 3, Grisel and Gweryyl Cochrane. *Children's children's children of Propositus*: X 4, Thomas George, Ralph Alexander, and Roger Cochrane. X 5, Archibald Douglas Cochrane (born 1885), a lieutenant of the Royal Navy. X 6, Louisa, Marjorie, Katherine, and Dorothy Cochrane.

#### BIBLIOGRAPHY.

- BURKE, SIR B., and A. 1909. *A Genealogical and Heraldic History of the Peerage and Baronetage*. London: Harrison and Son. 2570 pp.  
 FORTESCUE, J. 1895. *Dundonald*. London: Macmillan & Co. ix + 227 pp.



## 12. CUTHBERT COLLINGWOOD.

CUTHBERT COLLINGWOOD (Lord Collingwood), was born at Newcastle-on-Tyne, in September 1750. He was put on board the *Shannon* at the age of 11 years, under command of an uncle, Captain (after Admiral) Brathwaite. He gained his lieutenancy in the naval brigade at Boston, 1775, and four years later was made commander. From the age of 32 he was associated with Nelson until the latter's death, and frequently succeeded the older man when promotions occurred. In 1783 he, with Nelson, commanded at the West Indies to prevent the United States from trading there. As captain of the *Barfleur* he displayed judgment and courage in the naval battle of June 1, 1794, and on February 14, 1797, under Sir John Jervis, he assisted in defeating the Spanish fleet off Cape St. Vincent, and gained great fame in the battle by his vigorous support of Nelson at a time when the latter was suffering for his bold but hazardous stroke. As vice admiral he was sent in 1799 to watch the naval forces of France and Spain in the Mediterranean, and in 1803 he watched the French fleet off Brest and later at Cadiz. It was off the latter port that the battle of Trafalgar was fought, and here, as leader of the first attacking column, while Nelson led the second, Collingwood showed consummate valor and skill while his great flagship was shot almost to pieces. Trafalgar was won, but Nelson was killed and Collingwood took his place. He was raised to the peerage. He fought no more naval battles, but was constantly employed in cruises that involved good sense and political sagacity until he died at sea, 1810.

Collingwood was of the hypokinetic type. His father was a merchant who was rather ineffective. As a lad Collingwood was diligent at school, was fond of books, and exhibited then, as he always retained, the art of writing with a "polish, a sweetness of language and archness of humor, very close to some of the happiest compositions of Addison." At school he was a mild boy and showed no brilliant talents. He was reserved from boyhood; he was considered cold in his bearing, rather inaccessible, firm, and resolute. He lacked Nelson's sociable qualities. He would have silent moods when he would not speak a word for a day. However, at times he showed temper; but he was never known to swear or otherwise forget himself in his anger.

Collingwood's great strength lay in his thoroughness, good judgment, attachment to reality, self-reliance, and pertinacity. His thoroughness and good judgment made him invaluable in blockade and in watching the enemy's ships. "He deliberated carefully, weighing every contingency which his sagacity and forethought presented to him, and never overlooked anything of importance which it was possible for him to foresee." "His decisions were . . . reached by thoughtful processes. . . . His resolutions formed, they were as good as accomplished; he dispensed with self-questionings, and never flinched a hair's breadth from carrying them out." "His resolution was adamant; so that whoever came into close opposition to it must give way or be crushed. . . . His determination to be obeyed was absolute; disobedience meant destruction. Yet he rarely flogged, but preferred as punishment watering the grog and extra duty." He was always perfectly dignified in his deportment and constantly attended to his religious duties. Yet he was not without features of the hyperkinetic; was fond of society, joked in a quiet way, mostly by puns, and interspersed his conversation with humorous remarks and anecdotes. In the battle of Trafalgar his flagship penetrated into the very center of the enemy's fleet and almost alone finished the *Santa*

*Anna*, the flagship of the Spanish Admiral Alava; but he showed in this battle rather the devotion to duty and pertinacity of the solid, unexcitable sort.

There is no evidence that Collingwood had a special longing for the sea. Constantly he regrets that he can not return to his home. During his brief sojourn on land he made historical studies and educated his two daughters. He had a brother, Wilfred Collingwood, captain of the *Rattler* in the West Indian service, who died prematurely, and of whom the Duke of Clarence (later William IV) said: "his majesty has lost a faithful servant and the service a most excellent officer."

#### FAMILY HISTORY OF CUTHBERT COLLINGWOOD.

I 1 (F), Cuthbert Collingwood (died 1775), an unsuccessful merchant.  
I 2 (M), Micah Dobson. *Fraternity of M*: I 3, — Dobson. I 4, Admiral Brathwaite (died 1805, aged 80 years).

*Fraternity of Propositus*: II 2, Wilfred Collingwood (died 1787), captain of a naval vessel in the West Indian service. II 4 (*Propositus*), CUTHBERT COLLINGWOOD. II 5 (consort), Miss Blackett, of naval stock.

*Children of Propositus*: I 1, Sarah (born 1792) and 2, Mary Patience (born 1793) Collingwood.

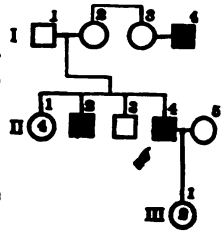

#### BIBLIOGRAPHY.

- DAVIES, W. 1875. *A Fine Old English Gentleman, exemplified in the life and character of Lord Collingwood*. London: Sampson, Low, Marston and Searle. 263 pp.  
RUSSELL, W. C. 1891. *Collingwood*. London: Methuen & Co. 271 pp.

### 13. WILLIAM BARKER CUSHING.

WILLIAM BARKER CUSHING was born at Delafield, Waukesha county, Wisconsin, November 1842. He was appointed to the Naval Academy in 1857, and resigned under pressure, without having distinguished himself in his studies, in March 1861. In May of the same year he was appointed master's mate, attached to the frigate *Minnesota*, one of the blockading squadron. Having shown great spirit, Cushing was appointed a lieutenant in July and in October was put in charge of a gunboat and ordered to capture Jacksonville, North Carolina, and seize any vessels found on the New river. He captured the city and three schooners, but on the return trip his gunboat ran aground. Sending off all its contents by one of the prize vessels, he fought the enemy as best he could on its arrival, then set fire to the gunboat and escaped in a skiff. For two years more Cushing played the part of a blockader with skill, vigilance, and energy. In October 1864, the Confederate ironclad ram *Albemarle* sank Federal naval vessels and threatened to regain control of Albemarle sound. Cushing had a plan for her destruction. He brought from New York an open launch provided with a boom to carry and direct a torpedo. At night he approached the *Albemarle* (lying in the Roanoke river), which opened fire upon him. As she was encircled by logs to ward off torpedoes, Cushing drove his launch through the cordon of logs and right up to the hull of the *Albemarle*; by lines attached to his body he aimed the torpedo, which exploded under the *Albemarle's* hull and sank it. At the same moment his launch was sunk by the enemy's fire, and out of the entire party only two, including Cushing, escaped. By swimming and rowing he made his way into Albemarle sound and to the Federal fleet; for this exploit he was promoted to be lieutenant commander. In similar daring fashion he attacked and reduced Fort Fisher. After the war he commanded the *Maumee* and was advanced to the grade of commander. He died of brain fever, December 1874, at the age of 32 years.

The prevailing trait of William Cushing was love of adventure. As a lad he was never happier than when playing some joke upon one of his elder brothers. Once he followed one of his brothers and a young lady to prayer-meeting and, sitting behind them, sang improvised personalities until sent out in disgrace by a church official. The father had died and his mother's cousin, Commodore (afterward Admiral) Joseph Smith, had him entered at the Naval Academy. Here his pranks and "sheer deviltry" continued and culminated towards the close of the winter of 1861, when he fixed a bucket of water over the door through which his teacher of Spanish was to pass on his way to an evening party; the teacher was deluged and the lad was permitted to resign. On one occasion during the war he wore General Hooker's new uniform coat to the theater. His naval exploits in the war partook largely of the nature of adventures.

Another trait was fearlessness, well illustrated by his aiming the torpedo accurately while only a few feet from the *Albemarle's* guns. He was a pronounced hyperkinetic. He was animated and enthusiastic in conversation. He spoke fluently, wrote easily and charmingly. He was generous and expressed his emotions fully. He would fight any man without the slightest hesitation, and was quick to resent an insult.

Cushing belonged to fighting stock, as the history of his three brothers shows. They were:

*Milton*, born in 1837, became a paymaster in the United States navy and was promoted to paymaster of the fleet, then in the Mediterranean. He was retired for disability and died, without issue, January 1886.

*Howard B.*, born in 1838, at 14 years of age became a printer's "devil" in a weekly newspaper office at Fredonia, New York; later he became a pressman in Boston, and then a type-setter in Chicago. In 1861 he raised a company of newspaper men in Chicago, but their services were not required. In 1862 he enlisted as a private in an Illinois volunteer artillery regiment. In 1863 he was promoted to a lieutenancy in the regular artillery. In 1867 he was lieutenant of Troop F, Third Cavalry, and was engaged in Indian warfare in Arizona and Texas. He was spare, active as a cat, and famous all over the southwestern border for coolness and energy. He was killed in May 1871, by the Apache Indians.

*Alonzo*, born in January 1841, was appointed cadet at West Point. Here he showed "himself modest in demeanor, but always efficient in his work and kindly toward under-classmen." He was appointed second lieutenant in artillery on graduating in June 1861, and was promoted to first lieutenant the same day. In Washington he drilled artillerymen, became ordnance officer, and later acted as aide-de-camp to Sumner in charge of topographical work. He advanced rapidly as topographical engineer through the grades to lieutenant colonel, up to the time of his death in battle, July 3, 1863. Elements contributing to his success were faithfulness in the discharge of every duty and thoroughness in its performance. "Possessed of mental and physical vigor, joined to the kindest of hearts, he commanded the love and respect of all who knew him. His fearlessness and resolution displayed in many actions were unsurpassed." One says of him, he "looked more like a school girl than a warrior, but he was the best fighting man I ever saw."

The father of this fraternity, Dr. Milton B. Cushing (born in 1800), was a restless man (see legend), but one of great personal attractiveness and sympathetic for the higher side of public questions. He suffered from ill health and left his family unprovided for. His father, Zattu Cushing, superintended the construction of a ship on an island opposite Erie, Pennsylvania. He was an upright, dignified, clear-headed man, and was for years a county judge.

The mother, Mary Butler Smith, married in 1836, when she was 29 years of age. She had a splendid physical and mental constitution and was "fortunately endowed with a passionate love for life in an open, free atmosphere, as near as practicable to nature itself. She had been reared among the most highly cultivated people of Boston, and was related to such distinguished families as the Adamses, Hancocks, and Phillipses." Just before the birth of her second son she was a bit gloomy and homesick. After the death of her husband she went to Fredonia, where she established a school.

Mary Smith's father's brother Albert's son, Commodore Joseph Smith of the navy, afterwards rear admiral, was born in Boston in 1790. He became midshipman in 1809 and lieutenant in 1813. As first lieutenant of the brig *Eagle* he took a conspicuous part in the battle of Lake Champlain, in September 1814, and was wounded. For his services he was voted a silver medal by Congress. In 1815 he participated in the war against Algiers; in 1827 he was commissioned commander. In 1837 he became captain; during 1846-1869 he was chief of the bureau of yards and docks, becoming rear admiral in 1862. From 1869 to 1871 he was president of the examination board for the promotion of officers, and died at Washington in 1877. His son, Joseph B. Smith, made a midshipman in 1841, had a reputation for rare courage. He became a lieutenant in 1855 and in 1862 was killed on the *Congress* in battle with the *Merrimac* in Hampton Roads.

Mary Smith had a sister, Elizabeth Winkle Smith, who married John Gilman Pillsbury. Their son was John Elliott Pillsbury, born December 1846, at Lowell, Massachusetts. Through the influence of the Hon. Albert Smith, he was made a page in the House of Representatives, 1859. At the request of Admiral Joseph Smith he was appointed midshipman in September 1862. He was graduated from the Naval Academy and was sent to the North Pacific squadron. In 1869 he was stationed at the Boston navy yard. He joined the *Colorado* (Admiral John Rodgers) for a cruise in Asiatic waters; in 1875 he was on the *Blake* for deep-sea soundings. He was assigned in 1879 to the *Kearsarge*, North Atlantic squadron, and in 1884 to the United States Coast Survey. Put in command of the *Blake*, he devised instruments to measure currents at various depths. He published "Dangers of the South Pacific," "Atlantic Local Coast Pilot Sub-division 19, 1885," and "The Gulf Stream." He married, in 1877, Florence Greenwood, and had one daughter, Elsie, born in 1877.

#### FAMILY HISTORY OF WILLIAM B. CUSHING.

*Fraternity of M M F*: I 1, — Bass, one of the "Boston Tea Party." I 2 (M M F), Moses Belcher Bass. I 3 (M M M), Margaret Sprague. I 4 (M F F), Josiah Smith. I 5 (M F M), Mary Barker, her consort's second cousin. I 6, Captain Robert L. Eells. I 7, Ruth Copeland.

II 1 (F F), Zattu Cushing (born about 1771), left Plymouth, Massachusetts, in 1791 and went to Ballston Spa, New York. In 1799 he superintended the construction of a ship on an island opposite Erie, Pennsylvania; in 1805 he settled in Fredonia, New York, where he was a judge for 14 years. *Fraternity of M M*: II 3, — Bass, a youth of great promise who died at 25 years of age on a voyage to England for his health. II 4 (M M), Mary Butler Bass. II 5 (M F), Elisha Smith. *Fraternity of M F*: II 7, Bosen Smith. II 8, Mary Barker. II 9, Josiah Smith, a shipbuilder. II 10, Albert Smith, a captain who commanded large ships. II 11, Anne Lenthal Eells.

III 1 (F), Milton Cushing (born 1800), studied at what is now Colgate University and practiced medicine; removed to Zanesville, Ohio, where he was a local merchant, then to Columbus, Ohio, and in 1837 to Wisconsin, where he was appointed justice of the peace. In 1844 he went to Chicago and practiced medicine and in 1847 went back to Ohio, where he died. III 2 (M), Mary Butler Smith. *Fraternity of M*: III 3, Cordelia Miller Smith. III 4, William Robert

Pearman. III 5, Joseph Bass Smith (born 1810), was lost or died at sea. III 6, Margaret Sprague Smith, an author of prose and verse. III 7, Joshua Loring Banker. III 8, Elisabeth W. Smith. III 9, John G. Pillsbury, a printer. III 10, Jane Read Smith. III 11, John Henry Batchelder. III 12, Sir Albert Jones Smith, a naval commander. III 14, Joseph Smith, a rear admiral of the United States navy. III 16, Albert Smith, a lawyer. III 17, Elisabeth Smith. III 18, Sarah Barker Smith. III 19, Joseph Eells.

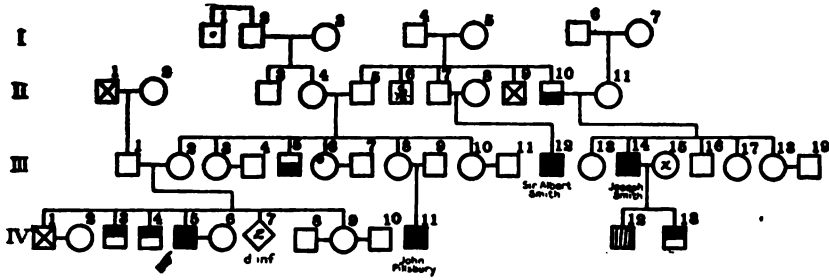

*Fraternity of Propositus:* IV 1, Milton Cushing (1837-1886), became a paymaster of the fleet. IV 2, Ellen Grosvenor. IV 3, Howard B. Cushing (1838-1871). IV 4, Alonso Cushing (1841-1863). IV 5 (*Propositus*), WILLIAM B. CUSHING. IV 6 (consort), Kate L. Forbes. IV 7, Walter and Mary R. Cushing. IV 8, Eli Bouton. IV 9, Mary Isabel Cushing (born 1847). IV 10, Edward F. Gayle. IV 11, John Elliott Pillsbury (born at Lowell, Massachusetts, 1846). IV 12, Joseph B. Smith, appointed a midshipman in 1841, became a lieutenant in 1855, and was killed in 1862 on the *Congress* in the conflict with the *Merrimac* at Hampton Roads. IV 13, Albert Smith, became a captain in the army and died from the effects of service during Civil War.

## BIBLIOGRAPHY.

- CUSHING, J. S. 1905. *Genealogy of the Cushing Family*. Montreal: Perrault Printing Co. lxx + 596 pp.
- HAIGHT, T. 1910. *Three Wisconsin Cushings*. Wisconsin History Commission. xiv + 109 pp.
- SMITH, S. 1895. *Memorial of Rev. Thomas Smith (second minister of Pembroke, Massachusetts) and his descendants*. Plymouth. 147 pp.

## 14. JOHN ADOLF DAHLGREN.

JOHN ADOLF DAHLGREN was born at Philadelphia, Pennsylvania, November 13, 1809. He was forced by the early death of his father to earn a living at the age of 15. Having only one strong taste, he applied for admittance to the navy as midshipman, but was not successful until February 1, 1826. After six years of service he successfully passed his examination. On account of his proficiency in mathematics he was detailed, in 1834, to the United States Coast Survey under Hassler, and entered upon triangulation work, particularly the measurement of the base on Long Island. In 1836 Dahlgren was made second assistant of the survey, with direction of a triangulation party. On account of eye-strain, Lieutenant Dahlgren visited France for relief and was obliged to retire to a farm from 1838 to 1842, but during this period he reported on the rocket-firing system of the French army. For a year or two he resumed active service in the navy and on the outbreak of the war with Mexico he was assigned to ordnance duty, especially in the rocket department. Having by experimentation proved the defects in the naval guns then in use, he devised first, in 1850, a light howitzer for small-boat use and then his 9-inch and 11-inch shell-guns, which introduced new principles into naval armament. He published technical books on ordnance and brought the ordnance department of the navy to great system and perfection. In 1857 he was given charge of the sloop of war *Plymouth*, of less than 1,500 tons, with permission to arm and equip her as he thought best. With her battery of 4.7-inch and 1.9-inch guns she became the most formidable craft afloat. In his voyage with the *Plymouth*, Commander Dahlgren was able to settle various diplomatic difficulties with other countries. Dahlgren experimented next on rifled cannon and urged the construction of ironclads, but his recommendations led to no response from an unprogressive naval board, and the Civil War found the government unprepared. Dahlgren's guns, nevertheless, won many important victories in the years that followed. Dahlgren was tremendously active on the *Chesapeake* and *Patriotic*; he was appointed chief of the bureau of ordnance with rank of captain in July 1862, and armed and equipped ironclads. As rear admiral from February 1863, he closed the Atlantic ports of the Confederacy. From 1868 to 1870 he was again chief of the ordnance bureau, and a few months before his death was appointed, for the second time, commandant of the Washington navy yard. He died in July 1870.

The most striking trait shown by Dahlgren was a desire to go into the navy. This is quite possibly a nomadic trait; certainly there is an appeal of the sea, as such. In the letter sent with his application for admission to the navy, at 15 years of age, occur such phrases as: "The decided wishes of John are for the navy and a seafaring life and no other object has any temptation for him." Again, "He is . . . so passionately bent on the destination of the navy of the United States that he can not be diverted from it," and he himself writes: "Having long been anxious to adopt as a profession the naval service of my country . . ." This desire for the navy was seen in his younger brother William, who, owing to a misunderstanding with John, vowed he would never be known as Dahlgren again; so he assumed his mother's name and thereafter was called William de Rohan. The National Cyclopaedia of American Biography (V, 24) states of William:

"He went to Europe, where his family connections and ample means brought him into intimacy with persons of the highest rank in life, including Admiral Hobart (Pasha), with whom he took service under the Sultan, with the rank of captain. Leaving the Turks, he went to the Argentine Republic with Garibaldi and com-

manded the naval forces of that country that brought about independence (1846). After that, when Garibaldi came to the United States, De Rohan went to Chile and became admiral of the Chilean navy. He took an active part with Garibaldi in the unification and independence of Italy. At this period he was not only made admiral of the Italian navy, but furnished money to buy 3 steamers, the nucleus of the Italian fleet. During the siege of Rome, De Rohan commanded the marine division and supervised the artillery fire. He spent many years in England, where he became interested in the workings of the British naval reserve, in which he was commissioned a commander by the admiralty. He was anxious to fight for the Union in the American Civil War, but was restrained by fear of being brought under the command of his brother. He was possessed of a large fortune when he entered the Italian navy, but lost it all because the Italian government refused to reimburse him. He sought redress in diplomatic circles, but all to no purpose, and he died in Philadelphia, the city of his birth, a poor man, in April 1891."

The trait of nomadism was in the father also, Bernard Ulrik Dahlgren, born in 1784. He was graduated from Upsala and was an adventuresome traveler at an early age, making frequent expeditions to hyperborean regions. At the age of 20, having become involved in an attempt to disseminate republican principles at Gefle, he was obliged to flee from Sweden and his property was confiscated by the Crown. After traveling extensively and incurring much hazard, he finally embarked from Spain for New York, where he landed December 1806. He was made Swedish consul at Philadelphia and held that post until his death. He was well known as a merchant of ability and great integrity. His judgment was clear and impartial, so that it commanded great confidence, and his arbitration was accepted as conclusive. He was a man of herculean stature and strength, being 6 feet 4 inches tall and well proportioned.

Father's brother, Sir Carl Adolf, was graduated at Upsala and was made a subphysician in the Royal Navy in 1797. He left the navy in 1800, but upon the outbreak of war in 1808 he offered his services to the government. He was appointed staff surgeon to the army of Finland, in which capacity he served until the close of the war. Thereupon he reentered the navy and thereafter held positions as court physician and field surgeon in chief to the army. He was created a knight of Wasa in recognition of his long and eminent service. He died at Stockholm in 1844. His son, Sir Johan Adolf, was the author of various dissertations on chemistry and medicinal botany and a "discoverer in the domain of practical chemistry." He also was created a knight of Wasa in recognition of prolonged and useful service. In 1871 he resigned the directorship of the Royal Military Hospital in Stockholm and after that led a retired life until his death in 1876.

Father's father, Johan Adolf Dahlgren, born at Norrköping in 1744, was educated by private tutors. He then studied chemistry and pharmacy and became a protégé and friend of Linnæus. He matriculated (1764) at the University of Upsala and was graduated with the degree of doctor of medicine. He was a man of great activity, a skillful physician, and a voluminous writer on medical subjects. In 1789 he was named chief physician of the province of Finland. He died in 1797.

Mother, Martha Rowan, was "richly endowed with the best qualities of head and heart." She had a special taste for designing, and her son often said that he inherited from her his inventive faculty.

Mother's father, James Rowan, was a Revolutionary soldier, who served as commissary in General Lacy's brigade and sustained heavy losses in his support

of the war. It is probable that he was related in some degree to Stephen Clegg Rowan, born near Dublin, Ireland, in 1808, who, when a child, came with his parents to the United States, was appointed midshipman in 1826, fought gallantly on land in Mexico, during the Civil War played an important part in blockading the coast of North Carolina, and eventually gained the rank of rear admiral, commandant of the Norfolk navy yard, commander in chief of the Asiatic squadron in 1870, superintendent of the Naval Observatory, and chairman of the lighthouse board in 1883. He died in Washington in 1890.

John A. Dahlgren as a young student was good in mathematics, as well as in Latin and Spanish. His teacher says: "He has received more honors than any other individual in my classes in the same time." At the age of 10 or 11 "he was continually occupied in reading universal history, particularly that of Greece and Rome." As midshipman, John Dahlgren's "mathematical training and proficiency and some knowledge of the use of instruments speedily attracted the attention of the learned chief of the Survey, Mr. Hassler."

Dahlgren had a keen sense of form. He had a fondness for birds — speaks of one that is hopping about in his cabin, resting on his knee at times. His manuscript books are "a marvel of painstaking care. Every letter and figure is drawn with the incisive clearness of a steel engraving, and no sign of weariness or haste is anywhere indicated."

John Dahlgren was enthusiastic in talking, affectionate in nature, and felt keenly the loss of each of such of his children as died. He is said to have been a man of severe nature. "To remain idle was not in his nature."

Dahlgren married twice: first, Mary Clement Bunker, a bright, joyous, generous, unselfish woman, a free spender, of gentle, affectionate nature and rare conversational powers. By her he had three children:

1. Charles Bunker Dahlgren, born in October 1839, near Philadelphia. He was educated at Rittenhouse Academy, Washington, and was graduated in 1857. He then studied ordnance and steam engineering at the West Point foundry, entered the engineer corps, United States navy, and was graduated at the head of a large class, but was transferred from the engineers corps to the line at the outbreak of the war. In 1863 he participated in the naval siege and capture of Vicksburg and was so efficiently active that he received a command. After three months in the hospital, he served under his father in front of Charleston and was in the bloody assault on Fort Fisher. After the war he practiced civil engineering, wrote a book on Mexico's historic mines, and participated on the *Resolute* in the Spanish-American war. He married in 1867, Augusta, daughter of William A. Smith. One of his sons is Ulric Dahlgren, born in 1870, professor of biology at Princeton, and author of memoirs on production of light and electricity by animals.

2. Ulric Dahlgren, born in Bucks county, Pennsylvania, 1842, was educated in Washington and was studying law at the outbreak of the early war. He was commissioned as captain and placed a battery of Dahlgren guns at Harper's Ferry in a difficult position. He made a daring and successful raid with one company into Fredericksburg and held the town against the opposition of a large force of the enemy's cavalry, and also served as aide to Generals Sigel, Burnside, Fremont, Hooker, and Pope. "At Chancellorsville he stayed the Confederate advance by a desperate charge." At the second Bull Run he was chief of artillery and prevented a disaster to the disorganized Union troops. In the Gettysburg campaign he destroyed 179 wagons of Lee's train, lost a leg, and won a colonelcy. He lost his life in a daring attempt to liberate Federal prisoners at Libby Prison and Belle Isle.



3. Paul was a lieutenant in the army, who resigned in 1873 and was appointed United States consul at Rome, where he died in 1874.

John A. Dahlgren's second wife was Mrs. Madeleine Vinton Goddard, the daughter of Hon. Samuel F. Vinton of Ohio, who for nearly a quarter of a century was a conspicuous member of Congress. On account of his knowledge of "the rules, great prudence, and sound judgment," he was "perhaps the most prominent leader on the Whig side." Her mother's father was Pierre Bureau, who immigrated to Ohio in 1792, and was one of the earliest state senators. Samuel Vinton's grandfather was Abiathar Vinton, a soldier in the Revolutionary war.

Of their children, John Vinton Dahlgren (born at Valparaiso, Chile, in April 1868) was graduated from Georgetown University, Washington, D. C., at the head of his class, was admitted to the bar in 1892, and began the practice of law in New York in 1894. In 1895 he became attorney for the department of buildings. In 1896 his eyesight began to fail (as had his father's) and he resigned. In 1898 the governor nominated him to the State Board of Charities. He married Elizabeth, daughter of the banker, Joseph W. Drexel, and died at Colorado Springs, Colorado, 1899.

Another son, Eric Dahlgren, who was graduated from Harvard College in 1889, married Lucy Drexel, sister of Elizabeth. They had 7 children. Eventually they were divorced, as he appeared to be inadequately endowed with inhibitions. He was affectionate by nature. One of the daughters, Katherine Drexel Dahlgren, has a love of speeding in high-powered motor cars; another entered a Roman Catholic sisterhood.

FAMILY HISTORY OF JOHN ADOLPH DAHLGREN.

I 1 (consort's F F F), Abiathar Vinton, a soldier in the Revolutionary war.  
 II 1 (F F), John Adolf Dahlgren (born in Norrköping, Sweden, in 1744), a leading Swedish man of science. II 3 (M F), James Rowan, a Revolutionary soldier. II 7 (consort's M F), Pierre Bureau, emigrated to Ohio in 1792, and was one of the earliest state senators.

*Fraternity of F:* III 1, Sir Carl Adolf Dahlgren, a pre-eminent government physician (see text). III 3 (F), Bernard Ulrik Dahlgren (1784-1824), a traveler and political refugee (see text). III 4 (M), Martha Rowan. III 5 (first consort's F), Nathan Bunker, an influential merchant of Philadelphia. III 7 (second consort's F), Samuel Vinton, a conspicuous member of Congress from Ohio.

IV 1, William A. Smith. IV 3, Sir Johan Adolph Dahlgren, was the author of various dissertations on chemistry and medicinal botany and a "discoverer in the domain of practical chemistry"; he was director of the Royal Military Hospital in Stockholm.

*Fraternity of Propositus:* IV 4, William Dahlgren (1819-1891), changed his name to William De Rohan, because of family disagreements. He was a soldier of fortune (see text). IV 6 (first consort), Mary Clement Bunker (died 1855). IV 7 (*Propositus*), JOHN ADOLPH DAHLGREN. IV 8 (second consort), Madeleine Vinton. IV 9, Hon. Daniel Convers Goddard. IV 10, Joseph W. Drexel (born at Philadelphia in 1831), a banker of eminence. IV 11, Lucy Wharton, an art and book collector.

V 1, Augusta Smith. V 2, Charles Bunker Dahlgren (born 1839), entered the engineer corps, United States navy. He participated in the naval siege and capture of Vicksburg and received a command. After the war he practiced civil engineering. V 3, Elizabeth Dahlgren (1840-1858), died of consumption. V 4, Ulric Dahlgren (1842-1864), was a volunteer militiaman of national reputation in the Civil War, and lost his life in a daring attempt to liberate Federal

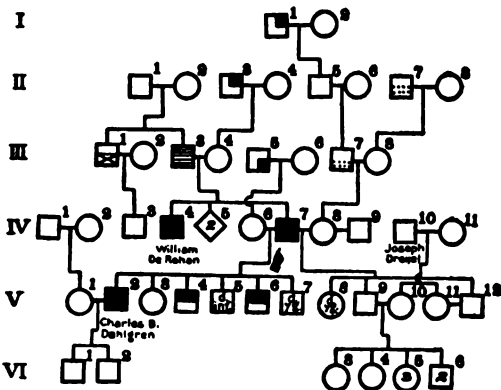

prisoners at Libby Prison and Belle Isle. V 5, John Dahlgren (born 1844). V 6, Paul Dahlgren (1846-1874) (see text). V 7, Lawrence Dahlgren, died young in 1851. V 8, Eva Dahlgren, died in 1870. V 9, Eric Dahlgren, of St. Paul and New York. V 10, Mary Drexel. V 11, Elizabeth Drexel. V 12, John Vinton Dahlgren (1868-1899), a brilliant lawyer who died prematurely.

VI 1, John A. Dahlgren. VI 2, Ulric Dahlgren (born 1870), professor of biology at Princeton since 1911. VI 3, Katherine Drexel Dahlgren. VI 4, Lucy Dahlgren, entered a Roman Catholic sisterhood. VI 5, Madeleine, Ulrica, and Olga Dahlgren. VI 6, Joseph and Eric Dahlgren.

## BIBLIOGRAPHY.

DAHLGREN, M. V. 1882. Memoir of John A. Dahlgren. Boston: J. Osgood and Co. xi + 3 + 660 pp.

## 15. STEPHEN DECATUR.

STEPHEN DECATUR was born January 5, 1779, at Sinepuxent, Worcester county, Maryland. He went on a cruise with his father at 8 years of age, and "was thus early introduced to the sea, toward which his inclination and ancestry ever urged him." He went to school until he was 17 years of age, when he entered the counting-house of a firm of ship-owners, but, at the beginning of the war with France, he showed such desire for naval service that he was taken by Commodore Barry on his ship *United States* as midshipman, 1798, and the next year was promoted to be lieutenant. In 1801 war had broken out with the Barbary States, and in 1802 Decatur sailed as first lieutenant for the Mediterranean, but was sent home for arranging a fatal duel between two young naval officers. He, however, soon returned to the Mediterranean fleet, under Commodore Preble, and was given command of the schooner *Enterprise*. In this he captured a Tripolitan ketch which was renamed the *Intrepid*. The American frigate *Philadelphia* having been captured, with all on board, by the Tripolitans, Decatur volunteered to "cut her out" with the *Intrepid* and was instructed by Preble to do so. The *Philadelphia* lay at anchor under the batteries (200 guns) of Tripoli, surrounded by 25 of the enemy's war vessels, and protected by nearly 30,000 men ashore and afloat. To oppose this force Decatur had one small (50-ton) ketch filled with combustibles and 84 armed men. At night he and his men, mistaken for traders, were allowed to come alongside of the *Philadelphia* to moor. They boarded the ship, killed 20 men, and routed the rest, without the wounding of a single American. They then set fire to the *Philadelphia* and rowed away just as the shore batteries began to fire upon them, but they were soon out of range (February 1804). Five months later Preble set sail to destroy the fleet in the harbor of Tripoli. Decatur was in command of one division of three gunboats and had to face, almost alone at first, the much more numerous fleet and the shore batteries of Tripoli. Stephen Decatur captured one gunboat by boarding her in a desperate encounter. His brother James had been treacherously killed while attempting to take a gunboat that had surrendered to him, and Stephen, learning of this, set out for the gunboat with 11 men, and killed and wounded so many of the officers and crew that the boat surrendered. The Tripolitans did not, thereafter, venture into a hand-to-hand encounter. Decatur was made captain at the age of 25.

In the War of 1812 Decatur was given command of the famous *United States* to hunt for English vessels. On October 25, 1812, he came upon the *Macedonian*, a new frigate somewhat inferior in fighting strength to the *United States*, as 5 to 7, and captured her with a loss only one-ninth that of his opponent. Returning to New York, he was transferred to the frigate *President*. In January 1815 he decided to run the blockade. The *President* grounded, on running out in a half

gale of wind, and was badly strained in getting off; also five British men-of-war chased her. One of these, the *Endymion*, he defeated; but the others coming up captured him and the *President*. Peace was signed shortly afterwards, and Decatur returned to his country. He was again, in charge of a squadron, sent to the Mediterranean against the Moors. He captured the *Meshoïda*, 46 guns, and forced treaties at Algiers and at Tripoli. Returning to America, he was appointed to serve with Commodores Rogers and Porter on the board of naval commissioners. He was killed in a duel with Commodore James Barron, March 1820.

Decatur possessed from boyhood a "love of the sea." This was recognized at the age of 8 years. It is said to have led him to oppose his mother's wish that he should become a priest and induced Commodore Barry to appoint him midshipman. He was, throughout life, averse to anything sedentary. His father and father's father were seamen. Little is known about the family of his mother, Anna Pine, who is said to have been the daughter of an "Irish gentleman."

Decatur had a fighting instinct that could be completely set into action. As a child his nature was considered fiery. His undertaking to burn the *Philadelphia* was a desperate one which succeeded by its pure audacity. When the *President* was discovered and chased by the British fleet he fought the swiftest of his opponents until she was helpless, until 24 on his ship were killed and 55 wounded, and until he was surrounded by three fresh, powerful enemy vessels. He fought two duels and was killed in one. It is said of him: "The high temper with which he had been born was kept under control, except in rare instances, when he was excited by injustice, deceit, or oppression." His brother James was a similar fighter.

He was tenacious, as in his hopeless battle with the *Endymion*. After he had suffered terrible slaughter he still kept on until every sail had been stripped from her yards and her battery had been completely silenced.

He was quick in decision, as when he jumped into the sea to rescue a man who had fallen overboard, and when, having learned of his brother's death by treachery, he chased and defeated the Tripolitan gunboat that had caused James's death.

FAMILY HISTORY OF STEPHEN DECATUR.

I 1 (F F), Etienne Decatur, of French and Dutch ancestry, became a citizen of Rhode Island in 1753. He was a sailor and a bold privateersman. He died in Philadelphia, leaving his family in straitened circumstances.

I 2 (F M), Mrs. Priscilla (George) Hill. I 3 (M F), — Pine, an Irish gentleman.

II 1 (F), Stephen Decatur (born 1752), commanded merchant ships and privateers with brilliant success during the Revolution. After the war he entered into partnership with a Philadelphia firm and made many voyages to France. In 1798 he was commissioned a captain of the navy. II 2 (M), Anna Pine, hoped that the propositus would be a clergyman.

*Fraternity of Propositus:* III 1, — Decatur. III 2, James Decatur, as lieutenant, had command of a gunboat off Tripoli and was mortally wounded in boarding a Tripolitan. III 3, John P. Decatur. III 5, Captain James M'Knight, of the marine corps. III 6, — Decatur. III 7, Dr. Hurst, of Philadelphia. III 8, (*Propositus*), STEPHEN DECATUR.

*Children of brother:* IV 1, Stephen Decatur, a lieutenant in the navy. IV 2, John P. Decatur, a midshipman.

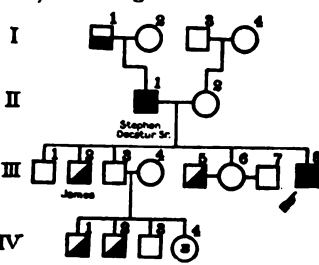

BIBLIOGRAPHY.

BRADY, C. 1900. Stephen Decatur. Boston: Small, Maynard & Co. xviii + 142 pp.  
 MACKENZIE, A. 1846. Life of Stephen Decatur. Boston: C. Little & J. Brown. xi + 443 pp.

## 16. GEORGE DEWEY.

GEORGE DEWEY was born at Montpelier, Vermont, December 26, 1837. He attended schools in Montpelier and Johnson, Vermont, and in 1851 he was admitted to the military academy at Norwich, Vermont. He decided to enter the Naval Academy, to which he was admitted in 1854 and from which he was graduated in 1858. He was active in the naval operations of the Civil War, especially as executive officer on the *Mississippi*, and was commissioned lieutenant commander for meritorious conduct in the attack on Fort Fisher. He taught in the Naval Academy, 1868 to 1870; was with the Pacific Survey; was on the lighthouse board; was at the European station in command of a ship, and eventually of the flagship, 1884 to 1888. Commissioned commodore, he was, in 1898, given command of the Asiatic station. When war with Spain broke out, Dewey, at Hong Kong, was cabled to operate against the Spanish fleet at the Philippine Islands. He steered his small fleet of 6 vessels at night through the narrow and mined entrance into Manila bay. At daybreak he destroyed the entire Spanish fleet of 12 vessels, his casualties being only 7 wounded. In the ensuing days and weeks he met such dangerous situations as the acts of the German admiral at Manila bay and the resistance of Aguinaldo with such judgment that the grade of admiral (previously held only by Farragut and David D. Porter) was revived in his favor. From 1900 until his death Dewey was president of the general board of the navy. He died at Washington of arteriosclerosis, January 16, 1917.

The traits that determined Dewey's career were:

*Love of adventure.* — Of his life at the district school he says:

"I was full of animal spirits and I liked things to happen wherever I was. Probably I had a gift for stirring up other boys to help me in my enterprises. A life of Hannibal which I received as a present fired my imagination. In winter it was easy to make believe that in storming a neighboring hill I was making the passage of the Alps. If there were no other soldiers to follow me, I might draft my sister Mary, who was 2 years my junior. . . .

"One of my favorite deeds of bravado was descending the old State House steps blindfolded, with the onlookers wondering whether I would slip on the way and take the rest of the fight head first."

On one occasion he thought it would be a great exploit to drive a horse and wagon across the swollen river; he escaped only by abandoning the wagon and climbing upon the horse's neck. To break his father's punishment he said: "You ought to be glad that I am alive!" At the Norwich Academy, when 17 years of age, he was disciplined for breaking up a service of hymns by standing outside and singing rival melodies. Even at Annapolis the "old faculty of making things happen had given me 113 demerit marks." Two hundred meant dismissal.

Dewey was excellent at mathematics, good in French and Spanish, but poor in history. "My weakness in history I overcame later in life, when I grew fond of reading."

He was quick in response. "A cadet who sat opposite me called me a name at mess which no man can hear without redress. I did not lose a second, and springing around the table, I went for him and beat him down under the table before we were separated." When, at Annapolis, a Southern cadet challenged him to a duel he accepted with alacrity. Rear Admiral Aaron Ward says of him:

"Dewey was a generous commander and made allowances for our greenness and was disposed to be indulgent with the average 'middy's' prank. . . . But this does not mean he was not a disciplinarian. . . . Slackness in work, untidiness, tardiness, and other shortcomings were abhorrent to him and he would not tolerate them."

He was always extremely prompt and Farragut was his beau ideal. In any difficult situation he asked himself: "What would Farragut do?" "I was thinking of him the night we entered Manila bay."

Brave and cool, he took the *Mississippi* (of Farragut's West Gulf squadron) through the river by the batteries of St. Philip and Jackson and stood intrepid on the bridge while the forts belched at him. When a Confederate ram suddenly appeared, he had the entire starboard broadside fired at her and sank her. The *Mississippi* lost her bearings in the smoke of battle and ran aground. She was burned and abandoned. Dewey was about the last person to leave, and while swimming to shore he saved a sailor from drowning at the risk of his own life. On opening the battle of Manila bay, he impressed all with his coolness as he commanded: "You may fire when you are ready, Gridley." He was a quick thinker, a sharp fighter, a precisian in courtesy and always neatly dressed. Like many other naval officers, he considered recognition of his own achievement as very important. He showed consideration for others, and relied on those he felt he could trust.

George Dewey's father was Julius Yeomans Dewey, a doctor of medicine of the University of Vermont; he was a man of vigorous constitution and active temperament, and a natural leader to whom men turned for advice, and who was very fixed in his ideas of right and wrong. The father's father of Dr. Julius Y. Dewey was Captain William Dewey, who was active in the Revolutionary war. He had a brother, Ensign Simeon Dewey, who accompanied Ethan Allen when he demanded the keys to the fortress at Ticonderoga. Dr. Julius Y. Dewey's father's father's mother was Mercy Saxton, a daughter's daughter of Captain George Denison, the "Miles Standish" of the Roxbury settlements. He was, except, perhaps, Captain John Mason, without equal in the colonies for conducting war against the Indians. He reminds us of the border men of Scotland. From him is descended also Minerva Denison, the mother of Rear Admiral John Rodgers (1812-1882).

On the mother's side we find that Admiral Dewey's mother's mother's father was a captain in the Revolution and the mother's mother's mother's father was the son of Captain Charles Maudsley, a lieutenant in King Philip's war.

Thus there are lines on both sides reaching back to fighters and a connection, through the Denisons, with Rear Admiral John Rodgers.

#### FAMILY HISTORY OF GEORGE DEWEY.

*Fraternity of F F F F F F F*: I 1, Jedediah Dewey (born 1647). I 2, Sarah Orton. I 3 (F F F F F F F), Josiah Dewey (1641-1731), was a carpenter and an influential and active citizen. I 4 (F F F F F F M), Hepsibah Lyman. I 5 (F F F F M M M), Bridget, who died in America. I 6 (F F F F M M F), George Denison (ca. 1618-1694), came to New England about 1631, but in 1643 returned to England, where he served in the army under Cromwell and was wounded at Naseby. Afterwards he returned to America and finally settled in Stonington, Connecticut. He is considered as great and brilliant a soldier as Miles Standish. "Our early history presents no character of bolder and more active spirit than Captain Denison. He reminds us of the border men of Scotland." I 7, Ann Borodell, of Irish ancestry, married Captain Denison soon after the battle of Naseby. From this marriage descended Minerva Denison, who married Commodore John Rodgers.

II 1, Jedediah Dewey (born 1670), a sergeant. II 3 (F F F F F F), Josiah Dewey (born 1666), a farmer. II 4 (F F F F F M), Mehitable Miller. II 5 (F F F F M F), Captain Joseph Saxton. II 6 (F F F F M M), Hannah Denison.

III 1, Jedediah Dewey (1714-1778), was a man of independent views who separated from the church and became a preacher, settling in Bennington, Vermont. He was one of the leaders in the efforts of the Vermont settlers to maintain their land titles. He preached to his people to take arms and go out to fight. Tradition has it that he adjourned church service to go to fight the British at the battle of Bennington, whence his name of "fighting parson." III 2, Mindwell Hayden. III 3 (F F F F F), William Dewey (born 1692). III 4 (F F F F M), Mercy Saxton. III 5 (M M F M F), Captain John Moseley.

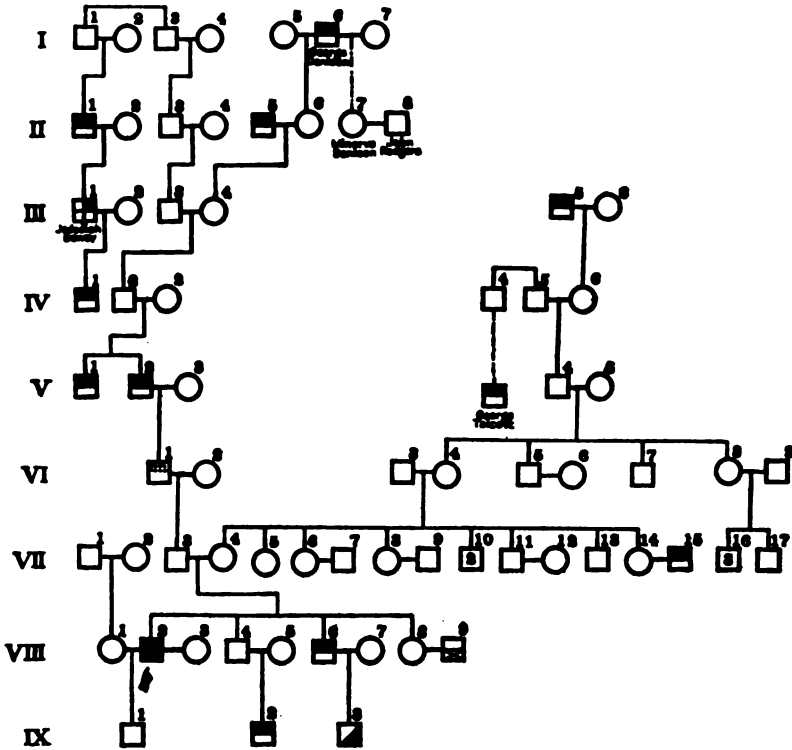

IV 1, Elijah Dewey (1744-1818), was a private in the first military company formed in Bennington, Vermont, in 1764. He was captain of a company in the early days of the Revolution and was at Ticonderoga, at the battle of Bennington, and at Saratoga. IV 2 (F F F F), Simeon Dewey (1770-1863), a farmer. IV 3 (F F F M), Anna Phelps. *Fraternity of M M F F*: IV 4, Elisur Talcott (born 1709), from whom are descended George Talcott (born 1786), a brigadier general in the United States army, and other men of military and engineering fame. IV 5 (M M F F), Captain Samuel Talcott (born Glastonbury, Connecticut), 1708. IV 6 (M M F M), Hannah Moseley.

*Fraternity of F F F*: V 1, Simeon Dewey (1745-1830), a blacksmith and gunsmith, was with Ethan Allen at Ticonderoga. V 2 (F F F), William Dewey (1746-1813), in 1776 moved to New Hampshire, where he farmed and did the work of a mechanic. He served as a corporal upon the Lexington alarm of 1775. V 3 (F F M), Rebecca Carrier (1746-1837). V 4 (M M F), Samuel Talcott (born 1733). V 5 (M M M), Mary Smith.

VI 1 (F F), Simeon Dewey (1770-1863), was a farmer who filled various town offices. VI 2 (F M), Prudence Yeomans, of Norwich, Vermont (1772-1844). VI 3 (M F), Zachariah Perrin (1748-1838). VI 4 (M M), Mary Talcott (1758-1828). *Fraternity of M M*: VI 5,

Samuel Talcott (1765-1839). VI 6, Abigail Hooker. VI 7, Nehemiah Talcott (1766-1848). VI 8, Hannah Talcott (1759-1848). VI 9, Epaphras Hills.

VII 1 (consort's F), Ichabod Goodwin (1796-1882), was a shipmaster who, as governor of New Hampshire during the Civil War, was known as the "Fighting Governor." VII 2 (consort's M), Sarah Parker Rice. VII 3 (F), Julius Yeomans Dewey, M.D. (1801-1877), practiced in Montpelier, Vermont. He was surgeon of the first regiment of the state militia, and president of the National Life Insurance Company. VII 4 (M), Mary Perrin (1799-1843), was educated in private school; was fond of books; she came from cultured stock. *Fraternity of M*: VII 5, Polly Perrin (1781-1798). VII 6, Betsey Perrin (born 1783). VII 7, Rev. James Hobart. VII 8, Pamela Perrin (1787-1813). VII 9, Deacon David Nye. VII 10, Porter (1790-1871) and Samuel (1785-1844) Perrin. VII 11, Truman Perrin (1796-1822), was graduated from Dartmouth College and became a clergyman. VII 12, Proney Tyndal, of Alabama. VII 13, William Perrin (1792-1824), a clergyman of South Carolina. VII 14, Sophia Perrin (born 1801). VII 15, Captain Joseph Somerby, removed to Michigan. VII 17, Elisur Hills (born 1782), was lost at sea.

VIII 1 (first consort), Susie B. Goodwin (died 1872). VIII 2 (*Propositus*), GEORGE DEWEY. VIII 3 (second consort), Mildred (McLean) Hasen. *Fraternity of Propositus*: VIII 4, Charles Dewey (born 1826), became president of the National Life Insurance Company; was elected state senator three terms and appointed state inspector of finance. VIII 5, Betsey Tarbox. VIII 6, Edward Dewey (born 1829), became a director of the family firm. In 1864 he entered the United States militia as quartermaster of the Eighth Vermont Volunteers; in 1865 was promoted to captain and assistant quartermaster in the staff department of the United States Volunteers. VIII 7, Susan Griggs Lilley. VIII 8, Mary Perrin Dewey (born 1839), of a modest, retiring disposition. VIII 9, George Preston Greeley, a surgeon in the army.

*Child of Propositus*: IX 1, George Goodwin Dewey (born 1872), after being graduated from Princeton College, became a traveling salesman. *Children of sibs*: IX 2, William Tarbox Dewey (born 1852), became a lieutenant in the Vermont National Guard; was director of the Vermont Mutual Fire Insurance Company. IX 3, Theodore Gibbs Dewey (born 1859), was graduated from the Naval Academy at Annapolis. In 1882 he was appointed midshipman on the United States Coast Survey; in 1897 he was promoted to lieutenant.

## BIBLIOGRAPHY.

- BALDWIN, J., and C. 1881. *A Record of the Descendants of Captain George Denison of Stonington, Connecticut*. Worcester: Tyler and Seagrave. 423 pp.
- BARRETT, J. 1899. *Admiral George Dewey*. New York: Harper's. 280 pp.
- CAULKINS, F. 1852. *History of New London, Connecticut*. New London: Press of Case, Tiffany & Co. xi + 670 pp.
- DEWEY, A. 1899. *The Life and Letters of Admiral Dewey*. New York: The Woolfall Co. 559 pp.
- DEWEY, G. 1913. *Autobiography of George Dewey*. New York: C. Scribners' Sons. xii + 337 pp.
- DEWEY, L. 1898. *Life of George Dewey, Rear Admiral United States Navy and Dewey Family History*. Westfield: Dewey Publishing Co. 1117 pp.
- TALCOTT, S. V. 1876. *Talcott Pedigree in England and America*. Albany: Weed, Parsons & Co. 316 pp.

## 17. ADAM DUNCAN.

ADAM DUNCAN was born July 1, 1731, at Lundie, Forfarshire, Scotland. After receiving the rudiments of an education at Dundee, he went to sea in 1746, under his mother's brother's son, Captain James Haldane. In 1755 he was lieutenant on the *Norwich*, one of the fleet under Admiral Keppel, which convoyed General Braddock's forces to America. In 1780, as captain in the *Monarch*, under Sir George Rodney, he was the first to engage the Spanish enemy off Cape St. Vincent. In May 1797, as rear admiral, he took his station off the Texel, where lay the Dutch squadron of 15 sail under De Winter. Owing to the widespread mutiny in the British fleet, he had only two ships. From time to time he caused signals to be made, as if to the main body of his fleet in the offing, and by this ruse prevented an attack on his helpless ships until, the mutiny quelled, he became heavily reinforced. On October 11 the enemy put to sea and he attacked them with a slightly superior force, capturing 11 of the 19 Dutch vessels. The water was shoal, the shore near, and a gale coming on; so he ceased action and took his battered prizes homeward, one sinking *en route*. For this victory he was created Viscount Duncan of Camperdown. He died 1804.

Duncan was a fighter of fighting stock. He declined a preferred command in order to watch and defeat the Dutch off the Texel. He married Henrietta Dundee, whose half-brother was a general in the army and the governor of Cape of Good Hope. Duncan's brother Alexander, a lieutenant colonel in the army, saw service in Canada and was the Major Duncan of Fenimore Cooper's "The Pathfinder." Another brother, John, was in the employ of the East India Company. Adam's son Henry (V 13) was a captain in the Royal Navy, and another son, Alexander, was a lieutenant colonel of the Coldstream Guards. Four second cousins of these sons (children of Captain James Haldane) gained some distinction in the navy. The first was Robert (1764-1842), who was under Adam Duncan on the *Monarch* and gained distinction; but in 1783 he left the navy to organize religious movements, in which he was somewhat successful. With others he organized the Society for the Propagation of the Gospel at Home. The other son was James Alexander (1768-1851), who at 17 became a midshipman, and eventually a captain. During a long detention of his ship he began the study of the Bible, abruptly quitted the naval service, began open-air preaching, and made repeated missionary journeys. He helped his brother organize the Propagandist Society and was ordained pastor of a large independent congregation. The scanty available genealogical data does not disclose the source of this family tendency to piety late in life.

## FAMILY HISTORY OF ADAM DUNCAN, FIRST VISCOUNT DUNCAN.

I 1 (consort's F F F), Robert Dundas, Lord Arniston, an eminent lawyer; member of Parliament. I 2 (consort's F F M), Margaret Sinclair. I 3 (F F F), Alexander Duncan, provost of Dundee, 1682-1685. He defended Dundee when John Graham tried to seize its municipal charters. I 5 (F M F), Sir Patrick Murray. I 6 (F M M), Margaret Haldane, daughter of Mungo Haldane, of Gleneagles county, Perth.

II 1, Anne Gordon. II 2 (consort's F F), Robert Dundas (1685-1753), was solicitor-general, 1717, and lord advocate of Scotland, 1720; a judge of session and, in 1748, president of the court. II 3 (consort's F M), Elizabeth Watson. II 4 (F F), Alexander Duncan (died 1719), provost, 1717. II 5 (F M), Isabella Murray. II 6 (M F), John Haldane of Gleneagles, member of Parliament.

III 1, Henry Dundas, first Viscount Melville (1742-1811), became solicitor-general to Scotland and then lord advocate. In 1791 he was home secretary; 1794-1801, secretary of war; in 1804 first lord of the admiralty, of which he was treasurer between 1782 and 1800. III 2,



Elizabeth Rennie. III 4 (second consort of consort's F), Jean Grant. III 5 (consort's F), Robert Dundas (1713-1787), solicitor-general of Scotland, lord advocate and lord president. III 6 (consort's M), Henrietta Carmichael (died 1755). *Fraternity of F*: III 7, Sir William Dundan (died 1774), was physician in ordinary to George III. III 8 (F), Alexander Duncan, provost of Dundee (1744-1746). III 9 (M), Helen Haldane.

IV 1, Elizabeth Dundas (died 1852). *Half Fraternity of Consort*: IV 2, Robert Dundas, (born 1753), was lord chief baron of the court of exchequer in Scotland and later solicitor-general and lord advocate. IV 3, Francis Dundas, lieutenant general and governor of the Cape of Good Hope. IV 4, William Dundas, privy councillor and secretary of war, 1804. IV 5, Philip Dundas, governor of Prince of Wales Island. *Fraternity of consort*: VI 7, Margaret and Anne Dundas. IV 8, Elizabeth Dundas. IV 9, Sir John Lockhart Ross (1721-1790), a gallant and highly distinguished naval officer. IV 10 (consort), Henrietta Dundas (died 1832). IV 11 (*Propositus*), ADAM DUNCAN, first Viscount Dundan. *Fraternity of Propositus*: IV 12, Margaret Duncan (died 1818). IV 13, William Tait. IV 14, Alexander Duncan, a lieutenant colonel in the army. IV 16, John Duncan. IV 17, Katherine Duncan (died 1774). IV 18, James Haldane, a captain in the navy. IV 19, Daniel Rutherford, a professor.

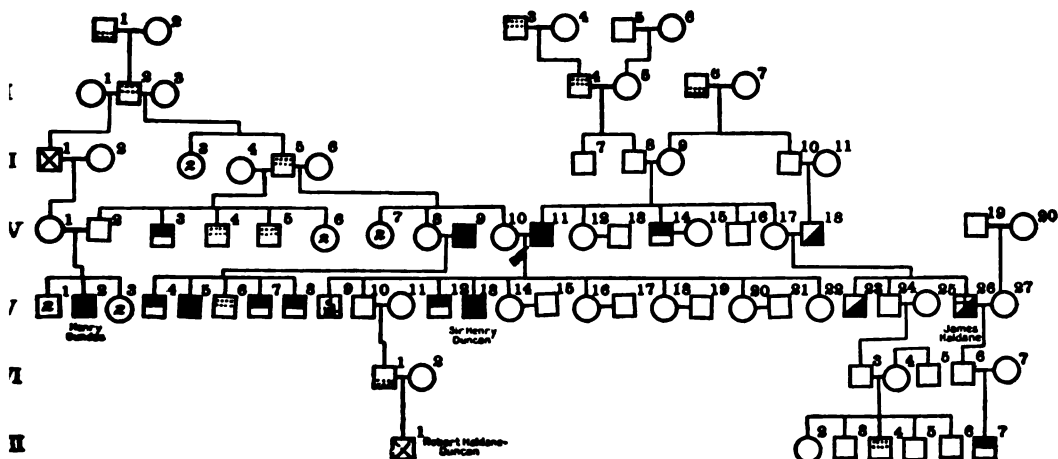

V 1, Robert (born 1797) and William Pitt Dundas. V 2, Henry Dundas, a vice admiral of the Royal Navy. V 4, Charles Lockhart-Ross, a colonel in the army. V 5, James Lockhart-Ross Farquharson, a captain of the Royal Navy. V 6, George Lockhart-Ross (born 1775), an advocate and judge. V 7, John Lockhart-Ross, a lieutenant colonel in the army, who was killed in 1809. V 8, Robert Lockhart-Ross, a colonel in the army. *Children of Propositus*: V 9, William Duncan (died at 9 years of age). V 10, Robert Duncan, second Viscount Dundan and first Earl of Camperdown (1785-1859); assumed the name of Haldane. V 11, Janet Dalrymple-Hamilton. V 12, Alexander Duncan (died 1803), a lieutenant colonel in the army. V 13, Sir Henry Duncan (1786-1835), a captain of the Royal Navy, C. B., K. C. H. V 14, Jane Duncan (died 1852). V 15, Sir Hew Dalrymple-Hamilton. V 16, Henrietta Duncan (died 1850). V 17, Sir James Fergusson. V 18, Adamina Duncan (died 1857). V 19, John Hamilton, Earl of Stair. V 20, Mary Tufton Duncan (died 1867). V 21, James Dundas of Dundas. V 22, Catherine Duncan (died 1833). V 23, Robert Haldane (1764-1842), served in the navy, but became a missionary (see text). V 26, James Alexander Haldane (1768-1851), served in the navy, but took up missionary work (see text). V 27, — Rutherford.

*Son's son of Propositus*: VI 1, Adam Haldane Duncan, second Earl of Camperdown (1812-1867), was a member of Parliament. VI 2, Juliana Philips. VI 3, Robert Haldane, a writer to the signet. VI 4, Mary Elizabeth Burdon-Sanderson. VI 5, John Scott Burdon-Sanderson (1828-1905), a well-known physiologist. VI 6, Daniel Rutherford Haldane (1824-1887), a prominent Scotch physician and president of Edinburgh College of Physicians.

*Son's son's son of Propositus*: VII 1, Robert Adam Philips Haldane-Duncan, third Earl of Camperdown (born 1841), was lord of the admiralty, 1870-1874. He is the author of "Admiral Duncan." VII 2, Elizabeth Sanderson Haldane, was a member of the arbitration board under the board of trade, of Scottish universities committee, and of the school board; vice chair-

man of territorial nursing service. In cooperation she has translated Hegel's "History of Philosophy" and is a writer of biography. VII 3, John Scott Haldane (born 1860), a physiologist, is joint editor and founder of the *Journal of Hygiene*. VII 4, Hon. Richard Burdon Haldane (born 1856), a British statesman who became secretary of state for war in 1905. He took first class honors in philosophy at Edinburgh University. VII 5, William Stowell Haldane (born 1864), author. VII 7, James Aylmer Lowthorpe Haldane (born 1862), is now a brigadier general in the army and has served with distinction in India and South Africa, winning medals and clasps. He has written, "How we Escaped from Pretoria."

## BIBLIOGRAPHY.

BURKE, SIR B., and A. 1909. A Genealogical and Heraldic History of the Peerage and Baronetage. London: Harrison and Son. 2570 pp.  
CAMPERDOWN, EARL OF. 1898. Admiral Duncan. London: Green and Co.

## 18. GEORGE KEITH ELPHINSTONE.

GEORGE KEITH ELPHINSTONE was born near Stirling, Scotland, January 7, 1746. He went to sea at the age of 15 years (1761), sailing on the *Gosport*, 44 guns, under Captain Jervis. Later he sailed on other naval vessels and then, since prevailing peace gave no chance for advancement, together with his brother he went into the East India Company, in whose service he was commissioned a lieutenant in 1767. Reentering the navy, he was assigned to the Mediterranean. Finding English deserters in Nice, he demanded that the authorities deliver them, and when they did not he took up his position off port until he got them. When, on entering the Bay of Naples in command of a small naval vessel, he was not officially received, he threatened to turn back no slaves that escaped to his ship. In 1775, as post captain in command of the *Romney*, he participated in the American revolution, taking American and French ships as prizes. He took an important part in the seizure of Charleston, South Carolina, where were captured 4,000 Americans, numerous weapons, and four war vessels. Sent back to England with dispatches, he was elected to Parliament and later returned to North America, where he helped fight two French vessels off Delaware bay. In 1787 he married a Miss Mercer, an heiress, and in 1788 a daughter was born, the only child of this union. In 1793, as captain of the *Robust* (74 guns), he joined the Mediterranean fleet to fight against the French revolutionists. At Toulon he was sent to support the land forces, and seized the shore forts. When Toulon was finally evacuated by the English, Elphinstone distinguished himself by getting away all the soldiers and thousands of the refugees. He was now made rear admiral and in 1795 commander in chief in Indian waters. He went to Cape Town and participated in the siege and capture of the Cape territory. As the French were now intriguing in India, Elphinstone, after organizing a naval station at Cape Town, made his way to Madras, where he was very ill. Learning that the combined French and Dutch fleets threatened Cape Town, he returned thither despite his illness, found the fleets in Saldanha bay, cut off all means of retreat for them, and caused them all to surrender without battle (August 1796). He then took the ships to Cape Town, turned them into English ships of war, and returned to England, where he was created Baron Keith. When the mutiny of the Nore broke out, 1797, Keith investigated it and was soon able to restore order; and he was similarly successful at Plymouth. In 1798 Keith was sent as second in command to Jervis, Earl St. Vincent. Owing to lack of harmony among the officers of the fleet, the French squadron at Brest escaped, and though forced by bad weather to return, none of the squadron was captured. St. Vincent's illness now left Keith in supreme com-

mand. In 1800 he was ordered to Egypt to recover it from the French. He made an admirable landing at Aboukir and captured Cairo and Alexandria in 1801. Returning to England in 1803, Keith was given command of the meager North Sea fleet and had to plan the coast defenses of England against France. His attempt to destroy French ships off Brest by means of fire-ships failed. In 1810 he was appointed admiral of the red and commander of the Channel fleet; as such he directed measures to meet the threatened invasion. When Bonaparte surrendered, Keith had to manage his care and keeping and expressed to the Emperor the decision of the government. Keith now retired to the estates that he was able to purchase with his great wealth. He built a large house at Kincardine-on-Forth, and planned piers, embankments, and reclamation walls. He was fond of society, but eschewed politics. He died in 1823. "Lord Keith was an accomplished and gallant officer, methodical, attentive, and correct; but otherwise he rose little above the commonplace." (Mahan, 1899, p. 364.)

Keith was a fighter of fighting stock, especially on his mother's side. Her mother's brother Francis (1696-1758) was graduated from the University of Edinburgh, and early showed a decided preference for a soldier's career; but as a Jacobite he and his brother George had to flee England (1715). He obtained a colonelcy in the Spanish army (1726-1727), later took command of a regiment in Russia (1728), and gained a high reputation. In 1747 he offered his services to Frederick II of Prussia, who made him field marshal and gave him and his brother George evidences of high personal regard. In 1756, when the Seven Years' War broke out, Francis Keith was given high command and gained still higher reputation for "resolution and promptitude of action as well as care and skill." After repeated engagements he was killed in 1758 at the battle of Hochkirch. Francis's brother George was less of a fighter and more of a diplomat; and having conveyed valuable information to Lord Chatham he was pardoned by George II and returned to Scotland in 1759.

Lord Keith had a brother, William (IV 7), who entered the Royal Navy, but later became connected with the East India Company and eventually became a director of it. Another brother, John (IV 5), entered the army and was later lieutenant governor of Edinburgh Castle; his son, Montstuart Elphinstone (1779-1859), received a civil appointment in the East India Company, through his uncle William, became attached as diplomatist to the mission of Sir Arthur Wellesley to the Mahrattas, and, though a civilian, acted virtually as Wellesley's aide-de-camp. At the battle of Assaye he displayed such military knowledge and insight that Wellesley told him he should have been a soldier. Appointed resident at Poona, he suspected treachery under the friendly mask of the peshwa and when that mask was thrown aside and war was declared Elphinstone assumed command of the British troops at a crisis in the battle of Kirkee and defeated the peshwa. Of his later career it is stated (Encycl. Britt., 11th ed.): "He may fairly be regarded as the founder of the system of state education in India." He twice refused the governor-generalship of India. He published a great history of India (1841). Still another brother of Keith was Charles (IV 6), who was also in the navy and who died on the *Prince George* when she took fire off Ushant Island in 1757.

The quality of diplomacy was marked in George also and had to be exercised at the Cape of Good Hope as well as in his relations with the captured Napoleon. George Lord Keith believed in obeying orders, however, and adhered to discipline even when his obedience of St. Vincent's orders lost him the capture of Bruix's fleet. He was just, considerate, and merciful, and was even reproved by the admiralty for furnishing a better diet to the sick than was prescribed by that authority.

## FAMILY HISTORY OF GEORGE KEITH ELPHINSTONE, VISCOUNT KEITH.

I 1 (M M F), William Keith, ninth Earl Marischal of Scotland.

*Fraternity of M M*: II 1, George Keith, tenth Earl Marischal (1693-1778), served under Marlborough and was a zealous Jacobite, taking part in the uprising of 1715, after which he escaped to the Continent. He lived for many years in Spain; then in 1745 he went to Prussia, where he held various diplomatic posts. II 2, Francis Edward James Keith (1696-1758), received a careful education under a relative, Robert Keith, Bishop of Fife, during which he "acquired that taste for literature which afterwards secured him the esteem of the most distinguished savants of Europe"; a field marshal in Russia. II 3 (M M), Lady Mary Keith (died 1799). II 4 (M F), John Fleming, sixth Earl Wigtoun. II 5 (F F), Charles Elphinstone, ninth Lord Elphinstone. II 6 (F M), Elizabeth Primrose.

III 1, James, third Lord Ruthven. III 2, Anne Stuart. III 3 (M), Clementine Fleming, a woman of great beauty and energy. III 4, Charles Elphinstone, tenth Lord Elphinstone. *Fraternity of F*: III 5, James and John Elphinstone. III 6, Archibald Elphinstone, an officer in the army. III 7, Grisel and Primrose Elphinstone.

IV 1, Cornelius Elliot. IV 3, John Ruthven (died 1771), a captain of the Royal Navy. IV 4, Anne Ruthven. *Fraternity of Propositus*: IV 5, John Elphinstone, eleventh Lord Elphinstone (1737-1794). IV

6, Charles Elphinstone, of the Royal Navy. IV 7, William Fullerton-Elphinstone, an East India director and previously commander of an Indianman. IV 8, Elizabeth Fullerton. IV 9, Mary, Eleanor, Primrose, and Clementina Elphinstone. IV 11, Sir Edward Buller, an admiral of the Royal Navy. IV 13 (first consort), James Mercer (died 1789). IV 14 (*Propositus*), GEORGE KEITH ELPHINSTONE, Viscount Keith. IV 14 (second consort), Hester Maria Thrale.

V 1, Janet (Elliot) Hyndford. V 2, John Elphinstone, twelfth Lord Elphinstone (died 1813), a lieutenant general in the army. V 3, Charles Elphinstone Fleming (born 1774), an admiral in the navy and governor of Greenwich Hospital. V 4, Donna Catalina Alessandro, a Spanish lady. V 5, James Elphinstone (died 1828) of Bengal, India. V 6, Mountstuart Elphinstone (1779-1859), a commissioner in India and governor of Bombay; one of the most able and distinguished men of his time in India. V 7, Anne, Clementina, Elizabeth, and Keith Elphinstone. V 8, John Elphinstone (died 1854), lived in India. V 9, Charles Elphinstone (born 1784) was in the Royal Navy and lost on the *Blenheim*. V 10, William George Keith Elphinstone, a major general in the army; died in command in India, 1842. V 11, James Buller-Fullerton-Elphinstone (1788-1857), a lieutenant colonel of the army. V 12, Anna Maria Buller. *Children of Propositus*: V 14, Margaret Mercer Elphinstone, Baroness Keith. V 15, Georgiana A. H. Elphinstone.

VI 1, John Elphinstone, thirteenth Lord Elphinstone (1807-1860), a captain in the army; governor of Madras and later of Bombay; created Baron Elphinstone in 1859. VI 2, John Elphinstone Fleming, fourteenth Lord Elphinstone (1819-1861), lieutenant colonel in the army. VI 4, William Buller Fullerton, fifteenth Lord Elphinstone (1828-1893), a captain in the Royal Navy. VI 5, Edward Charles Buller Fullerton (born 1832), a captain in the army. V 16, John Frederick Buller Fullerton (1837-1874), a lieutenant colonel in the army. VI 7, George James Buller Fullerton (1841-1879).

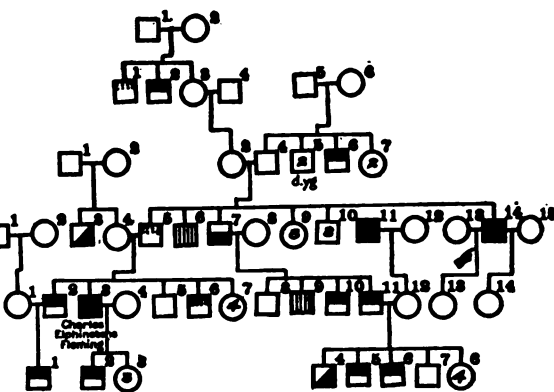

## BIBLIOGRAPHY.

- ALLARDYCE, A. 1882. Memoir of the Hon. George Keith Elphinstone, Viscount Keith, Admiral of the Red. Edinburgh and London: W. Blackwood and Sons.
- BURKE, Sir B., and A. 1909. A Genealogical and Heraldic History of the Peerage and Baronetage. London: Harrison and Son. 2570 pp.

## 19. DAVID GLASGOW FARRAGUT.

DAVID GLASGOW FARRAGUT was born at Campbell's Station, near Knoxville, Tennessee, on July 5, 1801. He spent a hardy and adventurous boyhood, first in Tennessee and then near New Orleans. An intimate friendship sprang up between the Farragut family and Commander David Porter, and the latter adopted young Farragut, since at the age of 8 years and shortly after the death of his mother he seemed to want to go to sea. He quickly became "fond of this adventurous sort of life." (Farragut, L., 1879, p. 11.) After a year of study in the East he received a midshipman's commission, December 1810. His first voyage was made on the *Essex*, of which his foster-father was captain, and he served on that ship during her romantic and fateful cruise in the Pacific in the War of 1812. He was in the bloody battle off Valparaiso when the ship was lost. Returning to the United States under parole, he studied for some months and in April 1815 sailed to Algiers. He soon returned to America, but in the spring of 1816 he sailed again for the Mediterranean, where he remained until 1820, becoming lieutenant at the end of that same year. He distinguished himself in encounters with pirates in the West Indies and showed decided ability and originality as a teacher on a receiving-ship. He served as an officer at the Norfolk navy yard and was executive officer of the *Pennsylvania* during the Mexican war. To him was assigned, in 1854, the establishment of the Mare Island navy yard, California. He was in San Francisco bay during the activities of the vigilance committee and steered a course of wisdom that tended to calm an excited population. After a year or two of service in the Gulf of Mexico, watching a revolution in Mexico, he returned to Norfolk, where he was stationed when Virginia seceded. He remained loyal. In 1862 he was appointed to the command of the Western Gulf blockading squadron, whose secret purpose was to open up the Mississippi from the gulf. He ran his fleet by the Forts Jackson and St. Philip, in the face of a terrific fire and with relatively slight loss. A few weeks later he carried his flotilla past the batteries at Vicksburg. He was now commissioned rear admiral. In March 1863 he passed the strongly placed batteries at Port Hudson in his flagship *Hartford*, but, with the exception of one gunboat, the remainder of the squadron was unable to follow. He remained between Port Hudson and Vicksburg, blockading the mouth of the Red river, until the fall of Vicksburg and Port Hudson in July 1863. After a few months in New York for recuperation and the repair of his ships, he departed, in January 1864, on the *Hartford*, to blockade Mobile. On August 5, 1864, he entered Mobile bay, despite strong fortifications and mines and the powerful ironclad *Tennessee*. A torpedo sunk the Federal monitor *Tecumseh*, which was in the van, and Farragut unhesitatingly seized the line at the critical moment; lashed to the mast, he ordered his flagship at full speed, taking the lead. The mines failed to explode and the bay was safely entered, though at the loss of many men, especially on the flagship. The *British Army and Navy Gazette* called him "the first naval officer of his day, as far as actual reputation, won by skill, courage, and hard fighting, goes." In the battle of Mobile bay shells were freely used instead of solid shot. A few days later all the forts were surrendered, with hundreds of men and scores of guns.

After the war Farragut had command for a time of the European squadron; he was voted the rank of admiral by Congress in 1866, and then retired from active service. He died at Portsmouth, New Hampshire, in 1870.

Farragut had "moral courage in assuming responsibility." At the age of 12, on the *Essex*, he was given command by Porter of the recaptured American ship *Barclay*, which had been seized by the British. The captain of the *Barclay* was furious at being superseded by such a lad, and when Porter's flagship had set sail this captain went for his pistols to prevent the seamen from executing Farragut's orders. Says Farragut, of this incident:

"I called my right-hand man of the crew and told him my situation. I also informed him that I wanted the main topsail filled. He answered with a clear, 'Ay, ay, sir!' in a manner which was not to be misunderstood, and my confidence was perfectly restored. From that moment I became master of the vessel, and immediately gave all necessary orders for making sail, notifying the captain not to come on deck with his pistols unless he wished to go overboard, for I would really have had very little trouble in having such an order obeyed."

When Farragut later reported to his superior, Captain Downes, the *Barclay's* captain's behavior, the latter insisted that he only tried to frighten the lad. "I replied by requesting Captain Downes to ask him how he succeeded." (Mahan, 1892, p. 26.)

When 12 years and 9 months of age he was on board the *Essex* in her final battle off Valparaiso, in which only 75 of her crew of 225 were uninjured. When Captain Porter was told that a gunner had deserted his post, Porter ordered Farragut to do his duty and the boy seized a pistol and went in pursuit of the fellow, but he had already left the ship in a boat. Of his gallantry in this engagement Porter made special mention in his dispatches. Of his activities during the terrible naval battle young Farragut says: "I performed the duties of captain's aid, quarter gunner, powder boy, and in fact did everything that was required of me." When, after the battle, Captain Hillyar, of the victorious English ship, saw Farragut's discomfiture, he spoke kindly, saying: "Never mind, my little fellow, it will be your turn next perhaps"; to which, says Farragut, "I replied I hoped so, and left the captain to hide my emotion." (Mahan, 1892, p. 49.)

Before he was 18 years of age Farragut, as acting lieutenant, was given command of a brig. He says of this circumstance: "I consider it a great advantage to obtain command young, having observed, as a general rule, that persons who come into authority late in life shrink from responsibility and often break down under its weight." (Mahan, 1892, pp. 60-61.)

When the passage of Forts Jackson and St. Philip was proposed to Farragut he showed "delight and enthusiasm," so that the secretary of the navy doubted for a moment if he were not too enthusiastic. The secretary soon "saw that in modest self-reliance he considered himself equal to the emergency and the expectation of the government."

Later, at the forts, Farragut decided to pass them without waiting to reduce them, as his orders from the navy department strictly implied. In this action he was opposed by Commander David D. Porter. Later Farragut passed the powerful forts at Port Hudson on his own responsibility. At the entrance to Mobile bay, when it was necessary for him to go in, the warning cry came that there were torpedoes ahead. "Damn the torpedoes," shouted the admiral in the exaltation of his high purpose. "Four bells [high speed], Captain Drayton, go ahead!" and none of the torpedoes exploded. Says Mahan (1892, pp. 318, 319):

"One of the greatest of naval commanders, whose experience with men extended through an unusually long and varied career — Earl St. Vincent — has declared that the true test of a man's courage is his power to bear responsibility; and Farragut's fearlessness of responsibility in order to accomplish necessary ends, while yet captain of a single ship, was the subject of admiring comment among his subordinates, who are not usually prone to recognize that quality in their commanders. 'I have as much pleasure in running into port in a gale of wind,' he wrote, 'as ever a boy did in a feat of skill.' The same characteristic was markedly shown under the weight of far greater issues in his determination to pass the river forts, in spite of remonstrances from his most able lieutenant, of cautious suggestions from other commanding officers, and with only the ambiguous instructions of the navy department to justify his action. It was not that the objections raised were trivial. They were of the most weighty and valid character, and in disregarding them Farragut showed not only the admirable insight which fastened upon the true military solution, but also the courage which dared to accept on his sole responsibility the immense risks of disaster which had to be taken.

"For the power to take these momentous decisions, Farragut was indebted to nature. He indeed justified them and his general course of action by good and sufficient reasons, but the reasons carried instant conviction to him because they struck a kindred chord in his breast. He once said: 'My motto in action is (quoting Danton), *L'audace, et encore de l'audace, et toujours de l'audace.*'"

Farragut had a love of the sea, though he was born far inland. It is said that the vast internal tracts and mountain slopes that he was free to roam over did not satisfy his craving. We have seen that, at a very early age, he had a love of adventure, a quality that marked his father.

Farragut as a lad, "while by no means insensible to the natural temptations of youth, . . . was ever more attracted to and influenced by the good than by the evil around him." He fortunately fell into good hands, and says: "Never having had any real love for dissipation, I easily got rid of the bad influences that had assailed me in the *John Adams*." (Mahan, 1892, p. 53.)

Strategic insight was shown in his method of passing forts, without reducing them, and depending for their fall upon their loss of communications, as at New Orleans and Mobile bay.

The temperament of Farragut was complex. He was subject to depressions, like Nelson, only less so. Bad news from Galveston, in January 1863, while he was in the lower Mississippi, depressed him greatly. But on the whole, especially in battle, he was very active. His temperament was of the kind that reacted strongly to insult. "At the age of 8 years, knowledge that a British naval vessel had fired into an American brig caused him to feel that the news was an insult to be paid in kind, and he was anxious to discharge the debt with interest."

*Father.* — George Farragut was born September 29, 1755, and "was sent to school at Barcelona, but was seized with the spirit of adventure and emigrated to America at an early age. . . . He arrived in 1776, promptly sided with the colonists, and served gallantly in their struggle for independence, as also in the War of 1812." In the mountains of eastern Tennessee he engaged in surveying. About 1802 "George Farragut moved to Louisiana, where he soon after entered the naval service and had charge of a gunboat on the Mississippi." "He was engaged in establishing the claim of the United States to the eastern Louisiana seacoast, occupied in part by the Spanish authorities." In 1811 he was "sailing master." Thus an official of the new territory reports: "At the special request

in 1839. III 5 (*Propositus*), DAVID G. FARRAGUT. III 6 (consort), Virginia Loyall, married Farragut, December 26, 1843. When the war broke out she decided to leave her family and go with her husband.

*Child of Propositus*: IV 1, Loyall Farragut, joined his father at Pensacola, October 1862, and was present with his father at the passing of Port Hudson, March 1863, where he showed great bravery and coolness; "he wanted to be stationed on deck and see the fight," though urged to go below. He was cool under fire (Farragut, 1879, p. 343). He wrote a life of his father in 1879.

## BIBLIOGRAPHY.

- BARNES, J. 1899. David G. Farragut. Boston: Small, Maynard & Co. xviii + 132 pp.  
 CHOATE, J. H. 1911. American Addresses, pp. 27-50. New York: The Century Co.  
 FARRAGUT, L. 1879. The life of David Glasgow Farragut. New York: D. Appleton & Co. vi + 586 pp.  
 HAYWOOD, M. 1903. Major George Farragut. (In: The Gulf States Historical Magazine, Vol. II, No. 2, pp. 90-98.)  
 HEADLEY, P. C. 1865. Life and Naval Career of Vice Admiral David Glasgow Farragut. New York: W. Appleton. 7-342 pp.  
 MAHAN, A. T. 1892. Admiral Farragut. New York: D. Appleton & Co. 333 pp.

## 20. MATTHEW FLINDERS.

MATTHEW FLINDERS was born, March 16, 1774, at Donington, England. He studied in the high school, from his twelfth to his fifteenth year, Latin, Greek, and mathematics. He then entered on a naval vessel, October 1789, and was made midshipman, July 1790, being assigned first to the *Bellerophon*. The next year he went under Captain William Bligh, on the *Providence*, to Tahiti, whence 500 young breadfruit trees were brought to St. Vincent and 500 to Jamaica, West Indies, the return route lying through Torres Strait. Upon his return to England Flinders was made aide-de-camp to Pasley on the *Bellerophon* and was in a battle off Brest in which Pasley lost a leg. In 1794 plans were made to send a new governor (Hunter) to Australia and Matthew Flinders and his brother Samuel Ward, who desired to go also, received appointments on the expedition. They left Plymouth in February 1795 and arrived at Port Jackson in September. He and another officer, Bass, at once set out to explore the coast in a boat 8 feet long with 5-foot beam and a sail. They went south to Botany Bay and beyond to Port Hacking. After spending some time on shore duty, Flinders, in February 1798, went in the schooner *Francis* on a trip to rescue some marooned sailors at the east end of Bass Strait and on this trip made extensive observations on the birds and mammals of the islands. Later in the year Flinders set out, accompanied by Bass, in command of a 25-ton sloop, the *Norfolk*, and circumnavigated Tasmania, thus making the first passage of Bass Strait. Returning to Sydney, Flinders sailed north along the Queensland coast looking in vain for large river-mouths. In March 1800 he returned to England with the ship that brought him. In the spring of 1801 while he was negotiating to be sent on an exploring and surveying trip to Australia, he married Ann Chappell, a sailor's daughter; and his plans to take his wife along were frustrated after they had nearly defeated his plans of the expedition. He finally sailed, July 18, 1801, in the 334-ton sloop *Investigator* with a company of 80, including John Franklin as midshipman and a number of other young, scientifically trained men. They made Cape Leeuwin, southwest Australia, in December 1801.

Flinders now carefully surveyed the south coast of Australia, particularly from King George's Sound eastward, so that many of his determinations and most



of his names serve to-day. He was the first white man to enter Spencer's Gulf and Gulf of St. Vincent, on which Adelaide now stands. He reached Port Jackson, May 8, 1802, pushed on and completed the circumnavigation of the continent in June 1803, the trip having been hastened because of the rottenness of the planks of his ship. Flinders now determined to go to England to carry his report to the admiralty and secure a better vessel in which to continue his explorations. On the return voyage he was wrecked on the Great Barrier Reef, but practically all of the company were landed on a sandy island. Flinders and an assistant rowed in an eight-oar cutter with 12 sailors back to Port Sydney, 700 miles. He returned with three vessels, by which the party was sent, some to Sydney, some to Canton, and a few with himself to England, via Torres Strait and Cape of Good Hope. In his 29-ton schooner Flinders was forced to stop at Mauritius, where the governor detained him from December 1803 to June 1810. Upon his return to England he set himself to prepare his charts and his book, "A Voyage to Terra Australis." As the book was passing through the press, Flinders died, at the age of 39, of some "constitutional internal trouble" which had caused him pain at Mauritius.

Flinders was a nomad with intellectual curiosity. He had a love of discovery. "As a child, he was one day lost for hours. He was ultimately found in the middle of one of the sea marshes, his pockets stuffed with pebbles, tracing the rivulets of water, so that by following them up he might find out whence they came." Asked in later life for juvenile anecdotes illustrative of personal character, he replied, that he was "induced to go to sea against the wishes of friends from reading Robinson Crusoe." But the book merely afforded the stimulus to which the mind and temperament of the reader determined the reaction. "The call of the sea was strong within him." The trip to Tahiti stimulated his "passion for exploring new countries," as Flinders says.

Whence this trait came is not clear from the biography; the father was a surgeon and so was the father's father. However, the father's brother, John, was in the navy, but did not altogether like it and was not successful in it. We naturally look for this nomadism among the male relatives of the mother, but about them we have no data. We know only that the mother's name was "Susannah Ward (1752-1783)."

The younger brother, Samuel Ward Flinders, desired to accompany his brother to Australia on two trips and became a lieutenant in the Royal Navy. Most interesting is the fact that Flinders's daughter Anne, who married a William Petrie, had a son, William Matthews Flinders Petrie, born 1863, who is the leading British Egyptologist, professor of Egyptology in the University College, London — as great a discoverer in his field as his mother's father was in another.

Flinders was a visualist. This shows itself in his neat, beautiful handwriting, in his careful, neat maps, in the appeal made upon him by organic as well as topographic forms. Indeed, it was largely the desire to see new things that lay at the basis of his love of discovery. Perhaps, as is often the case, his paternal ancestors were surgeons because of an appeal of form.

Flinders was intrepid. He started out in a 8-foot boat to explore the rugged shores of Australia. He pushed on around Australia in a sloop whose unseaworthiness was demonstrated shortly after the start on the voyage. He crossed the Indian Ocean in a schooner of 29 tons that leaked almost to the capacity of the pumps working night and day. He rowed in an open cutter 700 miles from Wreck Reef to Sydney along the coast of Australia.

He was industrious and conscientious. He was just; he opposed in naval court the sentencing of a man whom he believed to be wronged. He was haughty, and refused his captor's invitation to dinner — a refusal that brought him 7 years of internment. He was dogged; else he could never have succeeded with small or rotten ships and where the elements were arrayed against him.

Like most hyperkinetics (of which he was a mild representative), he was, when relaxed, a lively companion, a warm friend, and an entertaining conversationalist. He attracted men to him. He was generous to others, including other geographical discoverers on his own ground.

He was scholarly. He wrote a theory of tides, a paper on the magnetism of the globe, and a treatise on spherical trigonometry. Flinders was careful, conscientious, and accurate. "The excellence of his charts was such that to this day the Admiralty charts for those portions of the Australian coast where he did his original work bear upon them" his name.

FAMILY HISTORY OF MATTHEW FLINDERS.

I 1 (F F), John Flinders (born 1737), a surgeon.

II 1 (consort's F), — Chappell, a shipmaster. *Fraternity of F:* II 3, John Flinders (1766-1793), a lieutenant in the Royal Navy. II 4 (F), Matthew Flinders, a surgeon of excellent reputation who read a clinical paper before the Medical Society of London. II 5 (M), Susannah Ward (1752-1783).

III 1 (consort), Ann Chappell (1770-1852). III 2 (*Propositus*) MATTHEW FLINDERS. *Fraternity of Propositus:* III 3, Samuel Ward Flinders (1782-1842), a lieutenant in the Royal Navy.

*Child of Propositus:* IV 1, Ann Flinders. IV 2, William Petrie.

*Child of child of Propositus:* V 1, William Matthew Flinders Petrie (born 1863), the leading British Egyptologist and Professor of Egyptology in the University College, London.

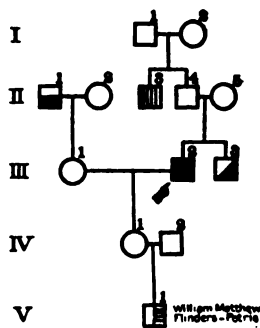

BIBLIOGRAPHY.

Scott, E. 1914. *The Life of Captain Matthew Flinders*, R. N. Sydney: Angus and Robertson. xviii + 492 pp.

## 21. ANDREW HULL FOOTE.

ANDREW HULL FOOTE was born at New Haven, Connecticut, September 12, 1806. He was a lively boy, indisposed to study or routine of any kind, and, though he had no bad traits, he loved freedom and fun. He led his brothers in pranks. Once, as a young lad, while crossing a field with his younger brother, Augustus, who was dressed in a red frock, he encountered an excited ram, which charged on the red frock. Andrew bravely threw himself in the way and received the shock of the ram, and this he did several times, until they had reached the fence in safety. He was ready to fight on occasion. At one time as a lad he entered a shoemaker's shop in the winter and neglected to close the door. One of the workmen ordered him peremptorily to shut the door. Not liking the tone of the order, Andrew refused to shut the door unless asked civilly. The workman replied that if he did not shut the door he would thrash him; Andrew, now aroused, knocked the workman down. "As a boy he was full of fun and frolic, a real boy, but he was genial, kind, and popular."

At Cheshire Academy he was not a good student, but was noted for his amiability and tact in getting out of the difficulties which his frolicsome disposition plunged him into. He early declared his intention of going to sea. His father compromised by entering him at West Point, but a few months later, at 16, he was transferred to the navy.

His first service in the navy was on the schooner *Grampus*, which was sent to exterminate the pirates around the West Indies. In March 1824 he started for the Pacific Ocean and served there for two years on the frigate *United States*, the flagship of Commodore Isaac Hull. During this voyage, at the age of about 18 years, he became "converted." He was commissioned lieutenant in May 1830 and cruised for some years in the Mediterranean. In 1837 he was assigned to the East India squadron and circumnavigated the globe in the *John Adams*. While at Honolulu he was a leading spirit in preparing and publishing a letter which corrected unfortunate misjudgments concerning American missionaries and maintained the principle that American missionaries everywhere are under the protection of the American flag.

In 1841 he was appointed to the Naval Asylum in Philadelphia and shortly after was put in full charge. At that time the asylum combined the functions of hospital and school and was the parent of the Naval Academy at Annapolis. Lieutenant Foote directed the care and education of the midshipmen. He also introduced the reform of no grog for the old seamen and supplied them all with Bibles. Foote was now sent in the brig *Perry* to the coast of Africa, to suppress the slave trade. Here he filled a difficult position with energy and clearheadedness. His relations with the English slave-ship hunters were cordial, but he could not consent to permit the British commander to board any vessel flying an American flag except on his own responsibility. In this he showed much diplomatic skill and secured British adherence to his main contention. His largest capture was the slaver *Martha*, whose captain denied having papers, but, on an examination of something floating near by, the captain's desk was discovered with information that resulted in the captain and crew going in irons to New York, where the ship was condemned as a slaver. She had planned to carry 1,800 slaves. The loss of the *Martha*, and slightly later of the slaver *Chatsworth*, did much to check the slave-trade. During four years ashore (1852-1856), Foote wrote a book, "Africa and

the American Flag"; also, he delivered lectures on temperance, on Liberia, and on Christian missions. He served on the Naval Efficiency Board at Washington.

In April 1856 Commander Foote was ordered to the East India station to join Commodore Armstrong's fleet in the *Portsmouth*, a sloop-of-war provided with Dahlgren guns. He was sent to the river at Canton, China, to protect Americans there. The Chinese and British were at war and Foote maintained an armed neutrality. On one occasion his boat was fired upon by the Chinese, without provocation. It was determined to prevent a recurrence of such an attack and all four forts guarding the river were captured, partly by fire from the ships and partly by storming, with a loss to the Americans of 7 killed and 22 wounded and to the Chinese of 200 to 500. This action made the American flag respected and paved the way for the advantageous treaties of Mr. Reed and Mr. Burlingame.

Upon his return to Atlantic waters Foote was placed in charge of the Brooklyn Navy Yard. Here his energy and executive talent led to improved discipline and to his frequent appointment as president of courts-martial. He also put in force his progressive ideas as to scientific as well as technical training for naval men.

When the Civil War broke out Foote was placed in command of naval operations on the "western rivers," meaning the rivers about the mouth of the Ohio. Nine iron-clad gunboats and numerous mortar-boats were being built and three wooden vessels had been purchased. By tremendous activity Foote got most of them ready for action before February 6, 1862, on which day he cooperated with Grant's troops in the attack on Fort Henry. Steaming his ironclads close up to the fort, they were fought, following his careful orders, with such vigor and accuracy that the fort was surrendered in a few hours, with a Union loss of only 2 men killed.

A few days later Foote cooperated again with Grant before Fort Donelson. This fort was placed partly on a high bluff and partly at the water's edge and was much stronger than Fort Henry. Foote planned to destroy the lower battery and then, ascending the river still farther, enfilade the front of the fort with broadsides. The fortifications were badly damaged, but the fleet had suffered so from the fire of the land guns that the boats had to retire just as the fort was about to fall. It was abandoned the following night. Foote was wounded in the foot and leg. This dangerous wound was eventually the cause of his death. Foote was for pushing the advantage of the fall of Fort Donelson by advancing up the river, but he was prevented from doing so fully by the military arm of the service. He was now directed to proceed toward Fort Columbus, on the Mississippi River. It occupied a powerful position, but the fall of the other river forts and the appearance of Foote's reinforced fleet in the river led his enemy to seek a parley under a flag of truce. Foote's curt replies still further shook their confidence and the fort was evacuated. Island No. 10, farther down the river, was passed at night by two gunboats which brought land forces across to the rear of its batteries. The batteries were thereupon abandoned and the island itself soon surrendered (April 7, 1862). The admiral had now to demand relief from service on account of his wound. He died June 26, 1863.

Andrew Hull Foote was self-reliant and adventurous, even audacious. His father once said that he had succeeded pretty well in controlling all of his boys except Andrew; him he had attempted only to guide. It was because he was so self-reliant and adventuresome that he succeeded in destroying the barrier forts

in the Canton river and the forts in the Cumberland and Tennessee rivers. Naval vessels are not ordinarily able to reduce strong land fortifications, as Nelson found to his sorrow at Teneriffe. It was highly audacious for Foote to bring his small fleet close to such strong fortifications; he succeeded because his vessels were the first naval ironclads in action. There was a good deal of this same self-reliance combined with pertinacity in his father, Samuel A. Foote, who was speaker of the Connecticut legislature, 1825-1826, and a member of Congress for three terms. He then was sent to the United States Senate, where he introduced the resolution as to the sale of public lands that was intended to raise the nullification doctrine and which led to the famous debate between Hayne and Webster. He forced the states' rights men to "show their colors." He became governor of Connecticut in 1834.

Foote was a fighter, even as a boy, as we have seen. His mother's father, Andrew Hull (1758-1827), became brigadier general of the Connecticut militia and was a distinctly efficient officer. At his death he was marshal of Connecticut.

Foote early declared his intention of going to sea, and at the age of 16 entered the navy. His mother's father, General Andrew Hull, was a merchant in the West India trade; he owned, among others, the brig *Trenton*, which was lost at sea. In those days many merchants went themselves to sea, as supercargo, to sell their merchandise and buy in exchange. Hull probably had a liking for the sea. Andrew's father was also in the West India trade for a time with his father-in-law and occasionally made voyages. Another grandson of General Andrew Hull was in the navy for a time — William Augustus Hitchcock, a son of Mary Hull and William R. Hitchcock.

General Andrew Hull had a second cousin, Joseph Hull, who during the Revolutionary war commanded a flotilla on Long Island Sound and later engaged in the whale fishery. His son, Isaac Hull (1773-1843), was born in Derby, Connecticut; with an "unconquerable passion for the sea," he became a cabin-boy on a merchant ship at the age of 14 years. It is related that, when the vessel was shipwrecked some two years later, young Hull saved the captain's life by supporting him in the water until they reached shore. Given command of a ship sailing to the West Indies, he gained such a reputation as a skillful mariner that, on the organization of the United States navy in 1798, he was commissioned a lieutenant and assigned to the *Constitution*. Sent by his captain, in 1799, to "cut out" the French letter-of-marque *Sandwich* at Puerto Plata, he boarded her successfully and spiked the guns of the land battery; but the illegal order and its consequences cost the Government dearly. Hull commanded a ship in Preble's squadron that was sent against the Barbary States. In 1811 he commanded the *Constitution*, which came near to an action with the British. During the war of 1812 the *Constitution* destroyed the *Guerrière*. After the war Hull served on the Navy Board and in charge of navy yards. He died in Philadelphia at the age of 70.

Foote loved fun from boyhood up, as we have seen. His brother, John Alfred Foote (1803-1891), was also especially fond of fun. Of his father it is said: "There was a vein of kindly humor in his make-up."

Foote was markedly pious, as shown repeatedly in the above history. His father, too, was a pious man and both the father's father and the father's mother's father became pastors of the Congregational Church at Cheshire, Connecticut.

The father of the propositus, Governor Samuel Augustus Foote, had a remarkably good heredity, especially on the mother's side. His mother's father, Samuel Hall (1695-1776), was a graduate of Yale College, sometime tutor there,

and later pastor at Cheshire; one of his brothers, John, was representative to the general court of Connecticut, and John's son, Lyman, signed the Declaration of Independence from Georgia and was elected governor of that State. John's sister, Eunice Hall, married Jonathan Law (1674-1750), governor of Connecticut (1741-1750); and her only son, Richard Law (1733-1806), was nominated to the Continental Congress that passed the Declaration of Independence, which he would have signed had he not been confined to the hospital at the time. In 1786 he was appointed chief-justice of the supreme court of the State and coöperated with Roger Sherman in revising the code of law of the State. This same Governor Jonathan Law was the mother's mother's father of Governor Samuel A. Foote. This line goes back to John Eliot, "Apostle to the Indians."

## FAMILY HISTORY OF ANDREW HULL FOOTE.

I 1 (F M M M F F), John Eliot (1604-1690), the "Apostle to the Indians." I 2 (F M M M F M), Hannah Mumford.

II 1 (F M M M F), Joseph Eliot (born 1638), a clergyman. II 2 (F M M M M), Sarah Brenton. *Fraternity of F M M M M*: II 3, William Brenton, from whom was descended Admiral Jahlcol Brenton (see Brenton family).

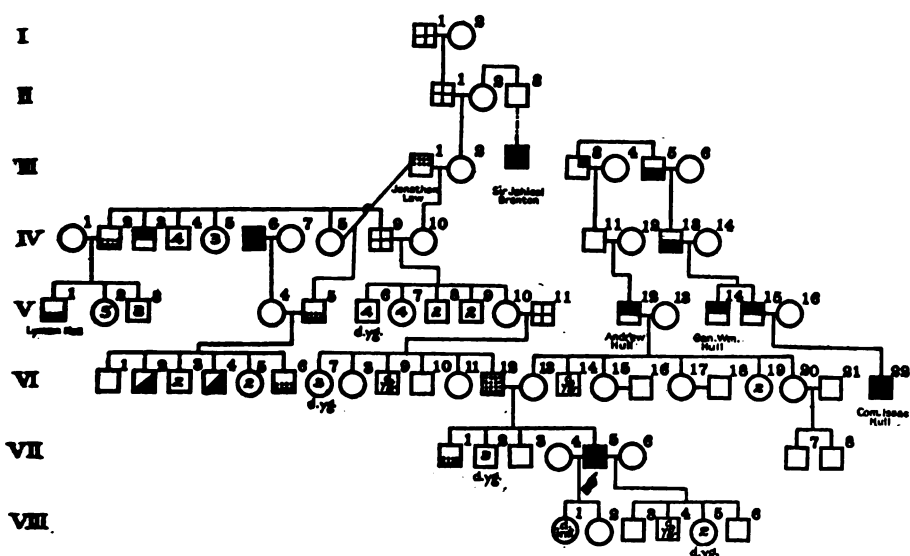

III 1 (F M M F), Jonathan Law (1674-1750), governor of Connecticut. III 2 (F M M M), Anne Eliot (born 1677). III 3 (M F F F), Caleb Hull (1695-1788), was an ensign who at the age of 80 years marched to the relief of Boston. III 4 (M F F M), Mercy Benham. *Fraternity of M F F F*: III 5, Joseph Hull (born 1694), a sea captain and a representative to the general assembly. III 6, Sarah Bennett.

IV 1, Mary Street. *Fraternity of F M F*: IV 2, John Hall (1692-1773), a representative to the general court. IV 3, Elihu Hall (born 1714), was graduated from Yale College; held the military rank of colonel; went to London. IV 4, Benjamin (died in infancy), Benjamin, Eliakim, and Caleb Hall. IV 5, Esther, Sarah, and Nancy Hall. IV 6, John Prentiss, commanded the armed colonial vessel *Defence*. IV 8, Eunice Hall (born 1700). IV 9 (F M F), Samuel Hall (1695-1776), pastor in Cheshire, Connecticut. IV 10 (F M M), Anna Law (born 1702). IV 11 (M F F), Andrew Hull (1726-1774). IV 12 (M F M), Lowly Cook. IV 13, Captain Joseph Hull (1728-1775). IV 14, Elizah Clark.

V 1, Lyman Hall (1731-1790), a physician of Georgia, who signed the Declaration of Independence. V 2, Hannah, Eunice, Susannah, Rhoda, and Mary Hall. V 3, John, Street, and

Giles Hall. V 4, Anne Prentiss. V 5, Richard Law (1733-1806), member of the Continental Congress. V 7, Lucy, Ann Mary, and Sarah Hall. V 8, Brenton and Jonathan Hall, were farmers. V 9, Samuel and Elisha Hall, were graduated from college. V 10 (F M), Abigail Hall (1748-1788). V 11 (F F), John Foote (born 1742), became pastor of the Congregational Church in Cheshire, Connecticut. V 12 (M F), Andrew Hull (born 1758), a brigadier general of the militia. V 13 (M M), Elizabeth Atwater. V 14, William Hull (1753-1800), served with distinction through the Revolution and was appointed lieutenant colonel in 1783. In the War of 1812 as brigadier general he surrendered to the English at Detroit. V 15, Joseph Hull, a lieutenant of artillery in the Revolutionary war; in early life was in the West India trade.

VI 1, John Law (born 1761), a lawyer. VI 2, Richard Law (born 1763), was captain of one of the first steam packets running between New York and New Haven; became a midshipman on the *Trumbull* and commandant and collector of the port of New London. VI 3, Jonathan (born 1765) and Christopher Law. VI 4, Benjamin Law (1767-1812), was in the United States navy. VI 5, Anne (1768-1849) and Mary (born 1775) Law. VI 6, Lyman Law (born 1770), a lawyer and member of Congress. *Fraternity of F*: VI 8, Mary Ann Foote (born 1770). VI 10, William Lambert Foote. VI 11, Lucinda Foote (born 1772), was qualified at the age of 12 years to enter Yale College. VI 12 (F), Samuel Augustus Foote (1780-1846), occasionally made voyages to the West Indies, having given up the study of law on account of his health. He was elected to both houses of Congress and in 1834 was chosen governor of Connecticut. VI 13 (M), Eudocia Hull, a "true executrix of the household." *Fraternity of M*: VI 15, Marab Hull. VI 16, Henry Whittlesey. VI 17, Elizabeth Hull. VI 18, Rev. Dr. A. Todd. VI 19, Sarah and Elizabeth Hull. V 20, Mary Hull. VI 21, William Hitchcock. VI 22, Isaac Hull (1773-1843), showed such skill in the West India trade that he was commissioned 4th lieutenant upon the organization of the United States navy in 1798. He distinguished himself in the War of 1812 as commander of the *Constitution* in the action with the *Guerrière*. A nephew of Isaac Hull, Joseph Bartine Hull (1832-1890), from 1862 to 1864 superintended the building of gunboats at St. Louis and commanded at the Philadelphia navy yard in 1866.

*Fraternity of Propositus*: VII 1, John Alfred Foote (1803-1891), member of Congress. VII 3, Augustus Edwin Foote. VII 4 (consort), Caroline Flagg. VII 5 (*Propositus*) ANDREW HULL FOOTE. VII 6 (consort), Caroline Street.

*Children of Propositus*: VIII 2, Josephine Foote (born 1837). VII 3, Augustus Foote (born 1847), in government employ at Washington, D.C. VIII 4, William Foote (1848-1862). VIII 6, John Foote (born 1859).

## BIBLIOGRAPHY.

- DAVIS, C. 1870. History of Wallingford, Connecticut. Meriden: The Author. pp. 806-821.  
 FOOTE, A. 1907. Foote Family. Rutland: Marble City Press. 5-607 pp.  
 HALL, S., and N. 1886. Genealogical Notes . . . of Hon. Lyman Hall of Georgia. Albany: J. Munsell's Sons. viii, 9-191 pp.  
 HOPPIN, J. 1874. Life of Andrew Hull Foote. New York: Harper & Bros. x, 14-411 pp.  
 MASON, P. 1894. A record of the Descendants of Richard Hull. Milwaukee: 3-78 pp.

## 22. EBENEZER FOX.

EBENEZER FOX was born at Roxbury, Massachusetts, January 30, 1763. He was the son of a tailor and belonged to a poor and large family. He was placed with a farmer at the age of 7 years. At 12 years of age, at a time when rebellion was in the air, he and another boy walked to Providence to go to sea; the love of freedom, the spirit of adventure, were with them. Fox shipped to the island of Santo Domingo and returned to near Providence, when two British war vessels intercepted them, their vessel was run aground, and Fox swam to shore. He entered the naval service, was captured, and kept on the prison-ship *Jersey*, but later he was sent to Jamaica, from which island he escaped and returned to America after the surrender of Cornwallis. In his autobiography he repeatedly admits a wanderlust.

## BIBLIOGRAPHY.

- FOX, E. 1847. The Adventures of Ebeneser Fox in the Revolutionary War. Boston: Fox. 240 pp.

## 23. JOHN FRANKLIN.

JOHN FRANKLIN was born at Spilsby, Lincolnshire, England, April 16, 1786. At about 14 years he cruised on a merchantman and at 15 was entered as midshipman on the *Polyphemus* and participated in her in the battle of Copenhagen (April 1801). Two months later he joined the *Investigator*, a ship of discovery, commanded by Captain Matthew Flinders (his kinsman), on which for nearly two years he surveyed the coasts of Australia. He was wrecked on a coral reef off Australia. Having returned to England, he joined the *Bellerophon* and was in charge of its signals during the battle of Trafalgar. At the close of the war with France (until which he was engaged in various naval services), he took up again the work of surveying. In 1818 he started for the Northwest Passage, in command of the *Trent*, but the accompanying *Dorothea* having become damaged by ice, Franklin had to convoy her home. The next year he was placed in command of an exploring party that started overland from the shores of Hudson's Bay to the Arctic shore near the mouth of the Coppermine river and back, a distance of 5,500 miles. In 1825 Captain Franklin was so steadfastly bent on going to sea that "to settle to business would be merely impossible." It was in action that his restless spirit always found it hardest to bear; a year and a half ashore was always a sufficient spell of the landsman's life for him. This year he went to Canada, descended the Mackenzie River to its mouth, and traced the North American coast as far as nearly to 150° West longitude. Honors were showered on him on his return to England, and he published, with Dr. Richardson, an account of his discoveries. He was next placed on the Mediterranean station for a few years and then, in 1836, he was made lieutenant governor of Tasmania, where he democratized the government, founded a college and a scientific society, and assisted in the formation of a magnetic observatory at Hobart Town. In 1844 he returned to England, where he entered into plans that had already been laid for polar research and was given charge of the expedition to discover a northwest passage. He left Greenland in high spirits, and this was the last heard of him directly. Subsequent search revealed that he spent the winter of 1845-1846 on Beechey Island; in the autumn of 1846 his ships *Erebus* and *Terror* were beset by ice and held by it during the following winter and summer. Sir John Franklin died in June 1847, and the survivors started, in April 1848, on an overland journey through northern Canada, but all perished on the way, leaving only their journals and bones to tell their fate to the search expeditions, notably that of McClintock (*q. v.*).

A brother, James (III 9), entered the East India Company's service as a cadet and served in the Pindari War; and a brother, Willingham, went to Madras as judge.

John Franklin had a native love of discovery — a curiosity. As a child he had an irrepressible desire to watch callers upon a family across the way who entertained a great deal. From the time of his visit in an exploring trip to Australia it was certainly maritime discovery rather than naval warfare upon which his mind was fixed. In 1835, while waiting for employment, he made a tour of Ireland with his wife; "Franklin's untiring intellectual curiosity and thirst for information made it impossible for him to regard any sojourn in a new country from the point of view of mere amusement, and his well-filled notebooks attest the diligence with which he endeavored to make himself thoroughly acquainted with the rural and economical conditions of Irish life." In Tasmania "he continued to lose himself and an exploring party in the hitherto unthreaded bush, from which, indeed, they



did not ultimately emerge into known or habitable regions until after his alarmed subjects had dispatched at least one expedition for his discovery and relief." "He loved adventure for adventure's sake, he reveled in strife, as strength and daring always revel. The thirst for discovery of the unknown glowed in his veins with an unquenchable and lifelong ardor." "He was a devourer of books of every kind."

A trait of scientific inquiry was in others of his family. His brother James in India became an officer of considerable scientific attainments and was employed on important surveys and was elected a fellow of the Royal Society. The well-known archeologist, William Matthew Flinders Petrie, is stated to be a grandson of Franklin's aunt.<sup>1</sup>

Other elements were a "dogged pertinacity and immovable self-control." His mother was a woman of great resolution of character. "He was frank in speech and bearing and had an open and affectionate disposition and a hot but generous temper, quick impetuosity, and marvelously elastic spirits. His manner was very quiet, as of one accustomed to command others." He received enthusiastic devotion from his followers.

FAMILY HISTORY OF SIR JOHN FRANKLIN.

I 1 (F F), John Franklin. I 2 (F M) —, "a woman of masculine capacity"; kept a small shop. I 3 (M F) —, a substantial farmer.

II 1 (F), Willingham Franklin, in early youth was apprenticed to a grocer and draper in Lincoln; became a banker. II 2 (M) Hannah —.

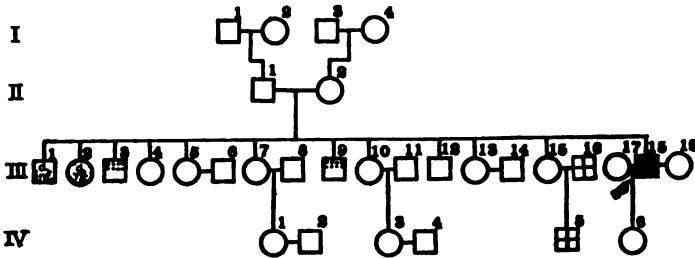

*Fraternity of Propositus:* III 3, Willingham Franklin (1779-1824), was educated at Oxford; a barrister. In 1822 he was appointed puisne judge of the supreme court at Madras. III 4, Elisabeth Franklin, died at an advanced age. III 7, Sarah Franklin, died early. III 8, Mr. Selwood. III 9, James Franklin (1783-1834), entered the East India Company's service as a cadet in 1805 and became an officer of considerable scientific attainment. He surveyed all of Bundelkhand and executed a valuable map of that region. III 10, Hannah Franklin. III 11, John Booth. III 13, Isabella Franklin. III 14, Thomas Robert Cracroft. III 15, Henrietta Franklin, died in extreme old age. III 16, Rev. Richard Wright. III 17 (first consort), Eleanor Anne Porden, had poetical ability. III 18 (*Propositus*), SIR JOHN FRANKLIN. III 19, Jane Griffin, sent out the relief expedition of 1857, which brought back the news of the fate of Sir John Franklin and records of the voyage.

IV 2, Alfred, Lord Tennyson, poet laureate of England. IV 3, Mary Booth. IV 4, Sir John Richardson (1787-1865), a famous surgeon and naturalist. IV 5, Canon Wright, Rector of Coningsby, Lincolnshire.

*Child of Propositus:* IV 6, Eleanor Franklin (born 1824).

BIBLIOGRAPHY.

MARKHAM, A. 1890. Life of Sir John Franklin and the Northwest Passage. New York: Dodd, Mead & Co. xii + 324 pp.  
 TRAILL, H. 1896. The Life of Sir John Franklin, R. N. London: J. Murray, 6 + 454 pp.

<sup>1</sup> Traill, 1896, states that Captain Matthew Flinders married an aunt of Franklin. The name of Flinders's consort was Ann Chappell. The name of Franklin's mother is not known.

## 24. THOMAS MASTERMAN HARDY.

THOMAS MASTERMAN HARDY was born April 5, 1769, in Dorset, England. After some early schooling he, in November 1781, went on board the naval brig *Helena* as "captain's servant" to Captain Francis Roberts. As a child, when the boys of the family were offered ponies by their father, he replied that Joe and Jack might have horses but that he wanted a wooden one, meaning, to go on a ship. From April 1783 to January 1784, he was on shore for an education. The story is told of his mounting the abbey tower with another boy and letting a third down by a rope to get eggs from a bird's nest. He then threatened to cut the rope unless the boy promised to give him 2 out of the 4 eggs.

Hardy was enrolled in the navy from January 1784 to October 1785, after which he evidently spent some time with his recently widowed mother and some time in the mercantile marine. In February 1790 he joined the *Hebe* as midshipman, cruised on the Channel, and was made lieutenant in 1793. In 1796 he moved into the *Minerve*, a large frigate recently captured from the French and upon which Nelson, now commanding, hoisted his pennant. In December 1796 the *Minerve* was in a battle with certain French frigates, one of which fell a prize, and Hardy was put in charge of it. But a Spanish squadron appeared just then, recaptured the frigate, and made Hardy prisoner; however, he was exchanged six weeks later. He took part in the naval victory off Cape St. Vincent. In May 1797 his ship came upon the beautiful and speedy French brig *Mutine* and Hardy was put in command of the boats sent to board her, and board her he did in daylight without the loss of a man; he was then promoted to the rank of commander and appointed to the *Mutine*. He accompanied Nelson to the Nile and in the battle his vessel did such service that he was promoted to be captain of Nelson's flagship. He was with Nelson during the latter's wasted months at and about Naples; was home for a time, and then again captain of Nelson's flagship on his expedition into the Baltic and before the battle of Copenhagen. In 1803 he was made captain of Nelson's ship *Victory*, and with it helped in the blockade of Toulon; in 1805 he led one squadron in Trafalgar (October 21, 1805), where Nelson was killed. Nelson had Hardy witness his will, and he died almost in Hardy's arms. Hardy was created a baronet in 1806. He now commanded ships in the North Atlantic and made some captures of American ships in the War of 1812. In 1815 he was appointed to a captaincy of the royal yacht *Princess Augusta*, which he retained for three years. In 1819 he was made commander in chief of the South Atlantic squadron, a position which, on account of the revolutions occurring in South American countries, required great tact and courage. In 1825 he was appointed rear admiral and was made chairman of a committee on changes in naval construction. He favored more 3-decked ships-of-the-line of 90 to 120 guns. He ended active service at sea on October 21, 1827, at the age of 58 years. For four years, 1830-1834, he was first sea lord of the admiralty; as such he "lived for the future," held opinions 30 years in advance of other admirals of his time, and appreciated the changes that science and steam were effecting. He favored large ships carrying heavy armament, and also he used to say: "Happen what will, England's duty is to take and keep the lead." From 1834 to 1839 Hardy was governor of the Greenwich Hospital. He died September 28, 1839, at the age of 70 years.

His traits were, first, a love of the sea, which showed itself very early and persisted; second, a quickness in meeting crises, as when he jumped into a boat to rescue a sailor who had fallen overboard. Nelson said of him: "Providence had imbued him with an intuitive right judgment." Hardy had no gift of eloquence and was no politician. He was a reformer, especially in matters of the navy, in which he showed great foresight.

He showed great tact and diplomacy. It is said of him (by Hall in Marshall's *Naval Biography*, page 180):

"Hardy was trusted everywhere, and enjoyed in wonderful degree the confidence and esteem of all parties. His advice, which was never obtruded, was never suspected, and a thousand little disputes were at once settled amicably, and to the advantage of all concerned, by a mere word of his, instead of being driven into what are called national questions, to last for years, and lead to no useful end. When this respect and confidence had once become fully established, everything went on so smoothly under his vigilant auspices that it was only those that chanced to be placed near the scene who could perceive the extent, or appreciate the importance, of the public good that he was quietly dispensing."

He had courage:

"He had always made his mark for good; raising, when the exigencies of the situation required it, the prestige of the English flag by some bold stroke of firm insistence."

Humanity was another of his traits, page 122:

"One of the most prominent characteristics of Hardy's generous and kindly nature was a solicitude for the comfort and happiness of those placed under his command. His anxiety about the young officers and sailors of his various ships is often quite touching. Even at that period, when the navy served as a sort of refuge for the very dregs of society, he believed in treating the British sailors as rational human beings, instead of as animals amenable only to fear of punishment. In the matter of discipline he was far in advance of his times. He was the first who had the courage to trust to the honor of his men and to dispense with the patrol of boats around the ships for the prevention of desertion. . . . At Greenwich Hospital Sir Thomas Hardy found a new sphere for his geniality and human sympathy. He rapidly became as popular with the pensioners . . . as he formerly was with the middies and the 'captains' servants.' . . . That which endeared him to every one was his amiable simplicity" (page 122).

#### BIBLIOGRAPHY.

BROADBENT, A. M., and R. G. BARTELOT. 1909. *Nelson's Hardy, His Life, Letters and Friends*. London: J. Murray. xx + 310 pp.

## 25. EDWARD HAWKE.

EDWARD HAWKE was born in 1705. He entered the British navy in 1720, was made post captain in 1734, and in 1743 was assigned to the command of the ship-of-the-line *Berwick*. In January 1744, under Admiral Mathews, he took part in the naval battle off Toulon and won distinction by the spirit he showed, engaging his antagonist in close action and capturing her. The king personally favored him and helped to advance him to the position of rear admiral in 1747. At that time he was given command of fourteen ships to intercept a French convoy. On October 14 he sighted the merchant fleet and its convoy of nine ships. He fought the convoy and six of its ships fell into his hands. In 1748 he became vice admiral of the blue squadron, having already been elected to Parliament, a seat which he retained for 30 years. On the outbreak of the war with France in 1756, Hawke was made full admiral. France was planning to invade England and Hawke was watching the French fleet under de Conflans in the Channel. When Hawke learned that the French fleet was at sea he put on all sail and after a chase of three days caught up with it. The enemy made for Quiberon bay, full of dangerous rocks and on a lee shore. Without order of battle the pursuers engaged the enemy's ships as they came up with them and poured shot into them. In three hours two French ships had sunk and two had struck, eight had run ashore, including the flagship, and eight had escaped. The British lost two ships on a shoal, but most of the people on board were saved. This great victory brought deserved recognition and the admiral was created Baron Hawke. He was lord of the admiralty from 1776 to 1781, when he died.

Hawke had the spirit of a fighter. There is insufficient knowledge as to his hereditary elements. We know, however, that his mother belonged to the Fairfaxes, one of England's greatest fighting families, and that his mother's mother's father was a general in the Parliamentary army in the early part of the seventeenth century.

## FAMILY HISTORY OF SIR EDWARD HAWKE.

I 1 (M F F), Thomas Bladen, a physician. I 2 (M F M), Sarah, daughter of Lord Blayney. I 3 (M M F), Sir William Fairfax of Steeton (born 1610), a general in the army, who saved the Parliamentary army from defeat and lost his life at the battle of Montgomery. I 4 (M M M), Frances Chaloner. I 5, Robert Stapleton. I 6, Catherine Fairfax, daughter of Viscount Thomas Fairfax of Gilling, a distant relative of M M F.

II 1 (M F), Nathaniel Bladen of Lincoln's Inn, barrister-at-law. II 2 (M M), Isabella Fairfax (1637-1691). *Fraternity of M M*: II 3, Thomas Fairfax (1633-1712), a general in the army and governor of Limerick. II 4, Catherine and Mary Fairfax. II 5, William Fairfax (1630-1672), saw military service. II 6, Catherine Stapleton.

III 1 (F), Edward Hawke, of Lincoln's Inn, barrister-at-law. III 2 (M), Elizabeth Bladen. *Fraternity of M*: III 3, Colonel Martin Bladen, comptroller of the mint, a Lord of Trade, and editor of a superb edition of "Cæsar's Commentaries." III 4, Hammond (died young) and Hammond Bladen. III 5, William Bladen, settled in Maryland. III 6, Frances and Isabel Bladen. III 7, Althea, Elizabeth, and Frances Fairfax. III 8, William Fairfax (died 1694). III 9, Robert Fairfax (1666-1725), was of a roving disposition and not fond of study. He first went to sea in a merchant ship. He was first lieutenant on the *Bonaventure* in the battle of Bantry Bay;

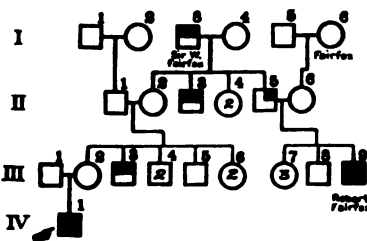

in 1690 he became captain and in 1708 was made vice admiral and later a lord of admiralty. Finally he retired to his estates and became a member of Parliament and lord mayor of York. He had sound judgment, was resourceful in an emergency, prompt, cool, and brave.

IV 1 (*Propositus*), SIR EDWARD HAWKE.

#### BIBLIOGRAPHY.

- BURKE, SIR B., and A. 1909. *A Genealogical and Heraldic History of the Peerage and Baronetage*. London: Harrison and Sons. 2570 pp.
- MAHAN, A. 1913. *Types of Naval Officers Drawn from the History of the British Navy*. Boston: Little, Brown & Co. pp. 77-147.
- MARKHAM, C. 1885. *Life of Robert Fairfax of Steeton*. London: Macmillan & Co.
- NEILL, E. 1868. *The Fairfaxes of England and America in the Seventeenth & Eighteenth Centuries*. Albany: J. Munsell. 234 pp.

#### 26. JOHN HAWKINS.

JOHN HAWKINS was born at Plymouth, England, in 1532, of a family of men of the sea. He "was bred to the sea in the ships of his family." He early sailed to the Guinea coast, robbed the Portuguese slavers, and then smuggled the captured negroes into the Spanish possessions of the New World at a time when foreign trade with them was strictly forbidden. His first voyage was in 1562-1563; later he lost two vessels, confiscated by the Spanish; but he repeated his earlier voyage with success, and thereby gained such a reputation that he was granted a coat of arms, with a negro, chained, as his crest. A third trip was undertaken as a national venture; again he kidnaped negroes, again he smuggled them into the Spanish colonies. Finding the settlement unfortified, he entered Vera Cruz harbor, but was caught there by a strong Spanish fleet and only two of his vessels (including his own) escaped. He now remained for a time on land, being, however, interested speculatively in privateering. In 1573 he became treasurer of the navy, succeeding his father-in-law. For the rest of his life he was the principal administrator of the navy. In 1588 he was sent, as rear admiral, against the Spanish armada and was knighted for his services. He twice went out to capture Spanish treasure-ships, but failed, and died at sea November 1595.

Hawkins "craved adventure," especially on the sea. He is called "the patriarch of the sea-rovers." Seamanship was his fixed passion; he read mathematics and studied navigation, theoretically and practically. "His devotion to the profession of the sea and his skill in it became a proverb in his own time." He lived on the sea from boyhood to the time when national duty "called him to administration"; but he went back to the sea and died on it. His father, William, was a great sea-captain. "In later years his seamanlike skill, his knowledge of the world, his adventurous disposition, and his genius for business obtained for him the distinguished favor of bluff King Hal." He was valiant in action and sage in counsel, a war commander of extreme versatility. On his mother's side the propositus was a son's daughter's son of Sir John Trelawny, who fought with King Henry at Agincourt and was rewarded for his bravery with a pension and an addition to his coat of arms. His brother, William, was a ship-owner and sailed to the Spanish Main in command of his own flotilla. Sir Richard, the son of the propositus, had similar daring. He fought with Drake and against the Spanish Armada, then set out for himself to prey on Spanish possessions in America under the guise of discovery. He entered the harbor of Valparaiso and plundered the

town, and came on to the bay of San Mateo, where he was captured by the Spaniards. He was imprisoned in Spain for five years and on his return to England was knighted. As vice admiral he went, in 1620-1621, to the Mediterranean to reduce the Algerian corsairs. His mother's father and grandfather were treasurers of the navy.

Associated with Hawkins's love of adventure was business astuteness, for the daring piratical raids and smuggling adventures were highly profitable. His father was thrifty, also, and was accounted perhaps the richest man in Plymouth. The son, Richard (V 5), commanded his Uncle William's ships on a trading expedition to the West Indies.

Another striking characteristic was statesmanship. "Among the richest of Britain's traders, they sought to establish the freedom of the seas" (though it involved piracy). They did much to destroy Spain's contention that she alone could trade with her colonies. Later in life his naval policy foreshadowed much that has since been worked into the English naval system." His brother was similarly a great administrator; he was tacitly regarded as governor of the port of Plymouth; he obtained from Queen Elizabeth a revised charter for the town and was early the town mayor. "Indeed, his local importance appears to have tended a little in the direction of monopoly." Their father in his early voyages to the coast of Brazil showed the characteristics of a statesman and a diplomat with his tact, discretion, and sagacity in dealing with the natives. He, too, was mayor of Plymouth and represented it in Parliament. Richard Hawkins also showed political sagacity in planning his trip to South American ports.

The propositus was bluff and blunt, sagacious and wily in council; his "nerve never deserted him." He was slow in formulating his own view, but when deliberately formed he could not be moved from it; but he was quick to see and prompt to act in urgent cases.

#### FAMILY HISTORY OF SIR JOHN HAWKINS.

I 1 (M F F), Sir John Trelawny (see text). I 2 (M F M), Blanche Pownde. I 3 (consort's F M F), —, Hussey, an admiralty judge.

II 1 (F F), John Hawkins. II 2 (F M), Joan Amadas. II 3 (M F), Roger Trelawny. II 5 (consort's F F), William Gonson, treasurer of the navy in the reigns of Henry VIII, Edward VI, and Mary. II 6 (consort's F M), Ursula Hussey.

III 1 (F), William Hawkins, one of the greatest sea captains in the west of England; an officer in the navy of Henry VIII; the first Englishman who sailed a ship into southern seas, making at least three voyages to Brazil. He was mayor of Plymouth and a member of Parliament. III 2 (M), Jane Trelawny. III 3 (consort's F), Benjamin Gonson, of Sebright Hall, near Chelmsford; treasurer of the navy (1549-1573).

*Fraternity of Propositus:* IV 2, William Hawkins, the most influential resident of Elizabethan Plymouth, of which town he was mayor; a ship-owner and commander, who held a commission under Prince Condé. IV 3, Mary Halse. IV 4 (*Propositus*), SIR JOHN HAWKINS. IV 5, (consort) Katherine Gonson. *Fraternity of M:* IV 6, Benjamin Gonson, born 1551. IV 7, Thomasine Gonson. IV 8, Edward Fenton, a noted navigator; captain of the *Gabriel* in the Arctic voyage of 1577 with Frobisher.

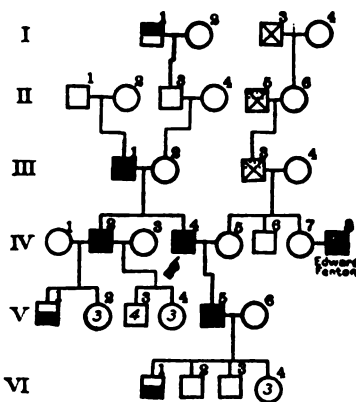

V I, William Hawkins (1565-1613), made voyages to the Straits of Magellan and the West Indies in 1582, sailing with Captain Fenton as lieutenant-general of his fleet, and being brought back in irons. In 1607 he sailed for the East Indies as captain of the *Hector*; founded the East India Company's first trading-house at Surat; was ambassador to the Great Mogul at Agra. V 2, Judith, Clare, and Grace Hawkins. V 3, Richard, Francis, Nicholas, and William Hawkins. V 4, Frances, Mary, and Elizabeth Hawkins. *Child of Propositus*: V 5, Sir Richard Hawkins (ca. 1560-1622), was his father's constant companion and was brought up to a sea life. In 1582 he made his first voyage to the West Indies with his uncle, William Hawkins; in 1585 he sailed with Drake and Frobisher to the West Indies. He commanded the *Swallow* against the Spanish Armada. In 1593 he went on an expedition of exploration around South America, was made a captive and sent to Spain for several years. He returned to England in 1603, was knighted, became vice admiral of Devon, a privy councilor and a member of Parliament. He died when engaged against the Algerian pirates. V 6, Judith.

*Child of child of Propositus*: VI 1, John Hawkins (born 1604), went to sea.

#### BIBLIOGRAPHY.

- HAWKINS, M. 1888. Plymouth Armada Heroes. The Hawkins Family. Plymouth: W. Brendon & Son. 189 pp.
- MARKHAM, C. R. 1878. The Hawkins' Voyages during the Reigns of Henry VIII, Queen Elizabeth, and James I. London: Printed for the Hakluyt Soc., vol. 57, liii: 453 pp.
- WALLING, R. 1907. A Sea-Dog of Devon. A Life of Sir John Hawkins. New York: The John Lane Co. xii + 288 pp.
- WORTH, R. N. 1886. A History of Devonshire. London: E. Stock. x + 347 pp.

#### 27. ESEK HOPKINS.

ESEK HOPKINS was born at Scituate, Rhode Island, 1718. At the age of 20 years he shipped on a vessel going to Surinam. He soon rose to the command of a vessel and became a prominent New England master mariner. He married in 1741 and moved to Providence in 1748. He served for a time on the school committee. Later he was, for 20 years, a trustee of Rhode Island College; also tax assessor, etc. From 1754 to 1763 he was privateering on French and Spanish vessels. He had become rich by 1756 and owned a farm of 200 acres and a house on it for his family; but he preferred "the dash and excitement incident to life on board a privateer." While on shore he was active in politics. When his brother Stephen was running for governor of the colony against Samuel Ward, Esek entered into the contest "with activity and acrimony." He was elected, in 1763 and 1764, to the general assembly; and he made long voyages to Africa, China, and the West Indies for four years. In 1771-1773 he was returned to the legislature. In 1775 a battery was established on Fox Hill in Providence Harbor and Hopkins was put in command of it. Shortly afterward he was appointed commander-in-chief of the fleet of the colony. In November 1775 he was appointed by Congress commander-in-chief of the continental navy. In February 1776 he started on a cruise to New Providence to get gunpowder, and secured cannon, shell, and a little gunpowder. Returning early in April, he captured a 6-gun English tender, *Hawke*, and the bomb-brig *Vulcan*, 8 guns. He next attacked the *Glasgow*, 29 guns, but she, being much larger than any of his fleet, succeeded in escaping. He was heavily censured for letting this ship escape, first by the people of the colonies and then by Congress, in August 1776. After some months of inactivity he was "dishonorably discharged" from the service, in April 1777. He passed the remainder of his life in Rhode Island, and was for many years a member of the assembly.

Hopkins was highly social and the struggles of political life appealed to him. In this respect he resembled his brother Stephen Hopkins (1707-1785), a signer

of the Declaration of Independence. Stephen was a surveyor as a young man, an occupation implying a high grade of scientific achievement for those days. He passed through all the political grades — town clerk, president of the town council, member of the assembly, and speaker thereof; he was also justice of the court of common pleas and later clerk of the court. In 1755 he opened an insurance office in Providence, and as he made money he bought books. In 1750 he sent to London for a collection of books. He became chief justice, 1751–1755; continental colonial governor, 1755–1762, 1763, 1764, and 1767–1768; and delegate to the colonial congresses of 1741, 1754, and 1757. In 1754 he espoused Franklin's plan for a union of the colonies, and during the whole period leading up to the Revolution he was one of the most active advocates of that plan. He signed the Declaration of Independence. He was a member of the Rhode Island council of war and a delegate to the convention of New England States. He helped found Rhode Island College (now Brown University) and was its first chancellor. He was editor, astronomer, historian, "orator, legislator, jurist, executive officer, and public-spirited citizen." He developed a marked paralysis agitans and died in 1785.

Esek Hopkins had a love of the sea. His brothers John and Samuel were masters of vessels. Esek married Desire Burroughs, daughter of Ezekiel Burroughs, a leading merchant and shipmaster of Newport, Rhode Island. One, at least, of their sons had the love of the sea (like Esek and his consort's father) and had the love of fighting like his own father. This son was John Burroughs Hopkins (1742–1796), who participated (at 30 years of age) in the burning of the *Gaspé* in Newport Harbor, 1772. He was a captain of one of the vessels of his father's fleet, the *Cabot*, in 1775. He led in the fight with the *Glasgow* and his ship suffered great damage, four of his crew being killed outright and seven wounded, including himself.

Esek Hopkins was a fearless man, despite his enemies' allegations. So too was his son. His father's father, a man of learning, when warned by the colonial authorities with others to remove to Newport for greater protection from the Indians, refused to do so; and, in 1698, he was put in command of the military forces of the mainland settlement of the colony.

Esek belonged to an intellectual strain; his own interest in learning led him to be put on school committees and to be made a trustee of the college. His father's father is said to have been a man of learning, a surveyor. Also, his mother's brother and father were surveyors. This love of learning, so marked in Stephen, was also found in Esek's daughter Heart (1744–1825), a woman of great culture, who, quite in advance of the period, took the regular course of study at the college under the special direction of its president, the husband of her sister, Susanna Maxey.

#### FAMILY HISTORY OF ESEK HOPKINS.

I 1 (FFF), Thomas Hopkins (born in England, 1616), joined in an agreement for a form of government for Providence Plantations; was commissioner, deputy, and town councilman. I 3 (MMF), Rev. William Wickenden.

II 1 (FF), William Hopkins (born ca. 1645), was a surveyor and military leader, and a man of learning and of courage (see text). II 2 (FM), Abigail Whipple. II 3, Samuel Dexter. II 4 (MF), Samuel Wilkinson, an expert surveyor and justice of peace. II 5 (MM), Plain Wickenden.

III 1, Major Sylvanus Scott. III 3 (F), William Hopkins, a farmer. III 4 (M), Ruth Wilkinson (1696–1738). *Fraternity of M*: III 5, Samuel Wilkinson (1674–172–), was a farmer, tanner, currier, and shoemaker. III 6, John Wilkinson (1677–1751), went to New Jersey and from thence to Pennsylvania. III 7, William Wilkinson (born 1680), was a preacher among



the Friends; went to Barbados and South America with a cargo and from thence to England, where he remained. III 8 (consort's F), Ezeziel Burroughs, a leading merchant and shipmaster of Newport, Rhode Island. III 10, Susannah Wilkinson, born 1688. III 11, James Angell. III 12, Joseph Wilkinson (1682-1740), a landowner and surveyor who held many offices. III 13, Martha Pray.

IV 1, Sarah Scott. *Fraternity of Propositus*: IV 2, Stephen Hopkins (1707-1785), a signer of the Declaration of Independence (see text). IV 3, William Hopkins (1705-1744), "early

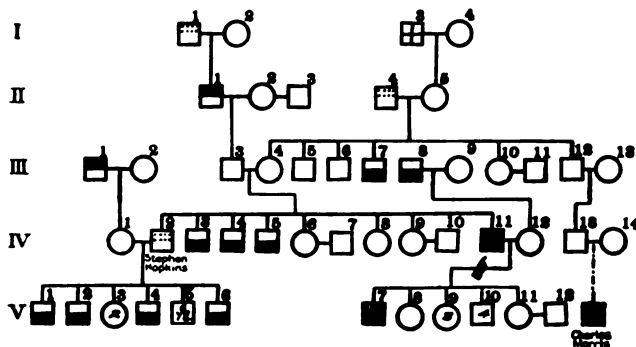

manifested a predilection for the sea" and became an expert navigator. In 1739 he was given command of an armed vessel to operate against the Spanish. IV 4, John Hopkins, master of a vessel. IV 5, Samuel Hopkins, master of a vessel. IV 6, Hope Hopkins. IV 7, Henry Harris, IV 8, Abigail Hopkins. IV 9, Susannah Hopkins. IV 10, Nathan Angell. IV 11 (*Propositus*). *Ezek Hopkins*. IV 12 (consort), Desire Burroughs. IV 13, Benjamin Wilkinson (1713-

1803). [See Morris family, No. 43, F M F.] IV 14, Mary Rhodes.

V 1, Rufus Hopkins (born 1727), was master of a ship and later a judge. V 2, John Hopkins (born 1728), a sea captain. V 3, Ruth and Lydia Hopkins. V 4, Sylvanus Hopkins (1734-1753), was a commander of a vessel at 18; was shipwrecked, and murdered by Indians. V 5, Simon Hopkins. V 6, George Hopkins, a sea captain who sailed from Providence and never was heard from again. *Children of Propositus*: V 7, John Burroughs Hopkins (1742-1796), a captain in his father's fleet. V 8, Heart Hopkins (1744-1825). V 9, Abigail, Amey, and Desire Hopkins. V 10, Samuel (born 1748), Stephen (1753-1761), Esek (1758-1777), and Samuel (died 1782) Hopkins. V 11, Susannah Hopkins (1756-1803). V 12, Jonathan Maxey, president of Rhode Island College.

#### BIBLIOGRAPHY.

- FIELD, E. 1898. Esek Hopkins, commander in chief of the Continental Navy (1775-1778). Providence: The Preston & Rounds Co. ix + 280 pp.
- WILKINSON, I. 1869. Memoirs of the Wilkinson Family. Jacksonville: Davis & Penniman. 585 pp.

#### 28. GEOFFREY THOMAS PHIPPS HORNBY.

GEOFFREY THOMAS PHIPPS HORNBY, was born at Winwick Church, England, February 20, 1825. At the age of 12 he went to sea in the flagship of Sir Robert Stopford, was present at the capture of Acre, in November 1840, visited the Cape of Good Hope, served as flag lieutenant to his father in the Pacific, and came home as a commander. In 1853 he married and, being politically out of favor of the admiralty, managed his father's estate until 1858, when he was sent to China to convoy a body of marines to Vancouver Island to contest with the United States the ownership of the archipelago of San Juan. As senior naval officer there Hornby's moderation prevented a fight and paved the way for arbitration. He kept at sea in various parts of the world until 1869. He then commanded the Channel fleet, and was for two years a junior lord of the admiralty. In 1877 he began service as commander in chief of the Mediterranean fleet; here he showed skill in maneuvers, disciplinary power, tact, and determination in conducting foreign relations at the time of the Russian advance on Constantinople, for all of which he was knighted. By 1880 he was regarded as the ablest commander on the active list of the navy. In 1888 he was promoted to be admiral of the fleet. He died March 1895.

Traits of Hornby's character are as follows:

*Nomadism and love of the sea.* — His great passion in childhood was the navy; every evening his occupation was to carve little boats out of small pieces of wood. He was fond of fishing, hunting, and shooting; "a sedentary life was entirely foreign to his habits and inclinations." Doubtless the elements of his tastes come to him from both sides. His mother's father was General "Saratoga" Burgoyne, who entered the army at an early age, eloped with a daughter of the Earl of Derby, soon had to sell his commission to meet his debts, and then lived abroad for seven years; and gambled recklessly. Later he devoted much time to art and drama. He fought against the American colonists and was badly defeated at Saratoga and deprived of his command. By an opera singer he had several illegitimate children, of whom one (Sir John Fox Burgoyne) became a British field marshal. Hornby's father was a naval officer who was given command of the Pacific squadron at 63 and was later appointed on the board of admiralty.

*Love of knowledge.* — This was early manifested at school. His favorite studies (next to strategy) were geology and chemistry. In later life he showed a scrupulous honesty and dislike of any half-truths. He took a keen interest in everything that came his way. One of his brothers studied at Oxford, and then became a captain in the Royal Engineers. Their mother was the "wisest woman that ever lived," her granddaughter writes.

*Appeal of form.* — This is shown in his interest in woodcraft, beginning with his childish carving of boats. As a boy he had a great passion for animals, especially horses and dogs. In the summer he gave much time to the care and study of bees.

He was of a calm temperament. As a boy he had a bad temper which he later brought under control. As a midshipman he was a "great favorite." He had, as an adult, "a wonderful charm of manner, a light-hearted bonhomie, and his eyes were lighted with an irresistible twinkle." He stirred others to enthusiasm by his keenness. He spoke shortly and to the point, sometimes very humorously. He was fond of the hunt. He was a man of judgment and insight into affairs, like his father, who was appointed to the board of admiralty.

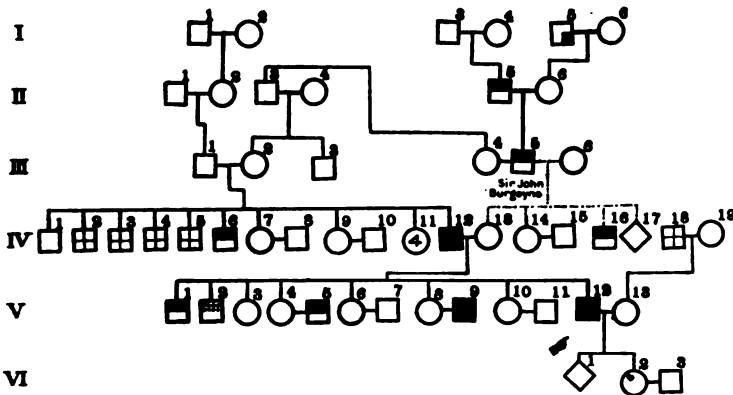

FAMILY HISTORY OF SIR GEOFFREY THOMAS PHIPPS HORNBY.

I 1 (F F M F), John Winckley. I 3 (M F F F), Sir John Burgoyne, reckless and extravagant. I 4 (M F F M), Constance Lucy. I 5 (M F M F), Charles Burnestone, a wealthy London merchant.

II 1 (F F F), Edmund Hornby. II 2 (F F M), Margaret Winckley. II 3 (F M F), James, Lord Stanley (1616-1671). II 4, Lucy Smith. II 5 (M F F), John Burgoyne, a captain in the army; ended his days on the King's Bench. II 6 (M F M), Maria Burnestone.

III 1 (F F), Geoffrey Hornby was a colonel in the army; afterwards he was rector of Winwick church. III 2 (F M), Lucy Stanley. III 3, Edward Stanley, twelfth Earl of Derby (1782-1834). His first marriage was unhappy; he became enamoured of a celebrated actress, whom he married six weeks after his first wife's death. He undertook the maintenance of the Burgoyne children. III 4, Charlotte Derby. III 5, John ("Saratoga") Burgoyne (1722-1792), entered the army early, made a runaway marriage, and had to sell his commission to pay his debts. He afterwards served in the Seven Years' War as brigadier general in Portugal, whom he won distinction, and at the beginning of the American War of Independence he was given a command. For his defeat at Saratoga he was deprived of his regiment. Later he was appointed commander in chief in Ireland. III 6, Susan Caulfield, an opera singer.

*Fraternity of Father:* IV 1, Edmund Hornby (1773-1857). IV 2, James John Hornby (1777-1855), rector of Winwick. IV 3, Geoffrey Hornby (1780-1850), rector of Bury. IV 4, Edward Hornby (born 1782), in holy orders. IV 5, George Hornby (1790-1872), in holy orders. IV 6, Charles Hornby (1791-1867), lieutenant colonel in the army. IV 7, Lucy Hornby. IV 8, Rev. H. Champneys. IV 8, Charlotte Hornby. IV 10, Edward, thirteenth Earl of Derby. IV 12 (F), Sir Phipps Hornby (1785-1867), entered the navy; was mate on the *Victory* under Nelson. March 1811 he commanded a 22-gun ship off *Lissa* and was awarded a gold medal. IV 13 (M), Maria Sophia Burgoyne, of lovely character. *Fraternity of Mother:* IV 15, — Parker. IV 16, John Fox Burgoyne (1782-1871), obtained his commission in the army in 1798. He won his brevets of major and lieutenant-colonel in 1812 for his skillful performance of engineer duties and after the war was made C. B. He finally rose to the rank of field marshal. IV 18 (consort's F), Rev. J. J. Coles.

*Fraternity of Propositus:* V 1, Phipps John Hornby (1820-1848), a captain of the Royal Engineers. V 2, James John Hornby (1826-1909), provost of Eton College. V 3, Maria Elizabeth Hornby. V 4, Caroline Lucy Hornby. V 5, Major General Sir William Denison. V 6, Susan Hornby. V 7, William Hornby. V 8, Lucy Hornby. V 9, Rear Admiral Robert Stopford. V 10, Elisabeth Hornby. V 11, Rev. John Cross. V 12 (*Propositus*), SIR GEORGE PHIPPS HORNBY. V 13 (consort), Emily Frances Coles.

*Children of Propositus:* VI 2, — Hornby, author of biography of her father. VI 3, — Egerton.

## BIBLIOGRAPHY.

- BURKE, J. 1914. *A Genealogical and Heraldic Dictionary of the Landed Gentry of Great Britain and Ireland*. London: Harrison and Sons. 2102 pp.
- BURKE, SIR B. and A. 1909. *A Genealogical and Heraldic History of the Peerage and Baronetage*. London: Harrison and Sons. 2570 pp.
- DE FONBLANQUE, E. 1876. *Political and Military Episodes in the Latter Half of the Eighteenth Century, Derived from the Life and Correspondence of the Right Hon. John Burgoyne*. London: Macmillan & Co. xiii + 500 pp.
- EGERTON, MRS. F. 1896. *Admiral of the Fleet Sir Geoffrey Phipps Hornby*. Edinburgh and London: W. Blackwood & Sons. xi + 404 pp.
- WROTTELSBY, G. 1873. *Life and Correspondence of Field Marshal Sir John Burgoyne*. 2 vols. London: R. Bentley & Sons.

29. WILLIAM HOSTE.

SIR WILLIAM HOSTE was born at Ingoldsthorpe, England, August 26, 1780. He entered the navy at 13 years of age under Nelson's special care. He was present at the battle of the Nile as lieutenant of the *Theseus* and after that battle was appointed commander and, in 1802, post captain. He continued operations in the Mediterranean and Adriatic until the end of his active career. From 1808 to 1814 he was watching for or fighting the French in the Adriatic and made a fortune from "prizes" of war. In 1811 his force of 4 frigates was attacked by a French squadron of six frigates and five small vessels; but Hoste, by his superior gunnery and maneuvering, defeated the enemy. He married Harriet, third daughter of Horatio, Earl of Orford, by whom he had 3 sons and 3 daughters. He died December 1828.

The traits that determined Hoste's success were:

*Restless activity.* — As a boy he was ever restless and buoyant; however, it is stated that he did not strongly prefer the navy but was placed in it by his parents. His favorite recreations were hunting and gunning, and these he continued to enjoy to the end of his life. In service he was ever active and vigilant. His brother Edward made an excellent sailor. He had an exceptional insight into the best way to meet a given naval situation, just as his brother George, a distinguished army engineer, was successful in meeting engineering problems.

Hoste was good-natured and generous. These traits endeared him to all who knew him. On shipboard he was universally beloved and followed with enthusiasm.

FAMILY HISTORY OF SIR WILLIAM HOSTE.

I 1 (F F F), James Hoste, of Dutch ancestry. I 2 (F F M), Anne Burleigh.

II 1 (F F), Theodore Hoste. II 2 (F M), Mary Hilmore. II 3 (M F), Henry Stanforth.

III 1 (F), Dixon Hoste, rector of Godwick and Sittershall.

III 2 (M), Margaret Stanforth. III 3 (consort's F), Horatio Walpole, first Earl of Orford.

*Fraternity of Propositus:* IV 1, George Hoste, received his commission in the corps of engineers in 1802; in 1805 he went with an expedition to Gibraltar and Italy and saw active service. Later he was present at the taking of Alexandria in Egypt. In 1810 he served at sea with Captain Brenton; during his service in Holland, in 1813, he obtained the brevet rank of major. He greatly distinguished himself at the battle of Waterloo, where he was attached to the Prince of Orange's corps (first) as commanding engineer, and was made C. B. He served on various military committees. IV 2, Dixon Hoste (1779-1805), was educated for the church and took a senior optime degree at Cambridge; was elected fellow of Trinity but soon after died of consumption. He was a young man of brilliant ability and promise. IV 4, Edward Hoste, went into the navy, serving under his brother; in 1813 he was appointed acting lieutenant of the brig *Wisard*. IV 5 (*Propositus*), SIR WILLIAM HOSTE. IV 6 (consort), Harriet Walpole.

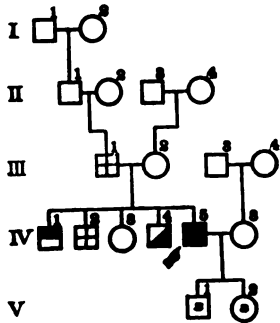

BIBLIOGRAPHY.

Howe, Mrs. W. 1883. *Memoirs and Letters of Captain Sir William Hoste*. London: R. Bentley. 2 vols.

## 30. RICHARD HOWE.

RICHARD HOWE, EARL HOWE, was born at London, March 8, 1726. He was a grandson of a mistress of George I ("a relationship," says David Hannay, in *Encycl. Britt.*, eleventh ed., "which does much to explain his early rise in the navy"). At the age of 14 he entered the *Severn* as midshipman and started for the South Seas, but the ship, having been disabled in a storm, returned to England. He went next to the West Indies on the *Burford* (Captain Lushington); in an attack on La Guayra the ship was damaged and the captain killed. In 1744 he was made acting lieutenant; and in the next year he commanded the sloop *Baltimore* and was wounded in the head in a fight with two French privateers. Made post captain in 1746, he commanded the *Cornwall* and brought her back injured from a fight with the Spaniards off Havana. He held various other commands between that time and the beginning of the Seven Years' War, and during that war he engaged in various trivial operations against the coast of France, which, whether failures or triumphs, added to his fame. In 1759, as captain of the *Magnanime*, he led Hawke's fleet to victory at Quiberon. From 1762 until the outbreak of the American Revolution Howe did shore duty; he ran for Parliament and was elected; was a member of the admiralty board and treasurer of the navy. In 1775 he was appointed vice admiral. In 1776 Lord Howe was appointed commander in chief of the North American station, with powers to treat with the disaffected colonists, as it was known that he was friendly to them. He conferred with governors of the colonies and communicated with George Washington, but meantime kept a firm hold on the cities of New York and Philadelphia. The sending of a new peace commission to America offended Howe and led him to resign, but before he could return to England the French fleet under d'Estaing, of nearly twice the strength of Howe's, arrived and he stayed on. He prevented it from entering New York harbor and forced it out of Newport harbor, so that it eventually found refuge in Boston harbor, where it was of least value. These maneuvers were a fine combination of caution and calculated daring. Howe returned to England and refused further service, embittered at the ministry's bungling and antagonism to him. In 1782 a change of ministry occurred and Howe was appointed admiral of the blue and ordered to watch the Dutch fleet in the Channel. He also protected incoming ships from the combined French and Spanish fleet. He next convoyed a large number of supply ships to the beleaguered garrison at Gibraltar and, though the fleet of the enemy was superior to his own, he landed his supplies and men and returned without injury, due to his extraordinarily fine handling of his fleet and to the incapacity of the enemy's. From the age of 56 to 67 years he performed land service, much of the time as first lord of the admiralty. In 1790 he was again called upon to command the Channel fleet, as admiral of the white. Finally, as admiral and commander in chief of the fleet, he, in 1794, fought the "battle of the first of June," in which he won a brilliant victory by hard fighting, though it was not decisive. He died five years later, his one remaining service being to compose an extensive mutiny, largely due to failure in discipline resulting from his advanced age. He quieted the disturbance by granting the mutineers all they asked. He died August 1799.

Howe was of the hypokinetic type, though not so depressed as Nelson. He was remarkably taciturn. Once, early in his career, an army officer of rank addressed him questions without receiving a reply and said: "Mr. Howe, don't you hear me?"

I have asked you several questions." Howe answered: "I don't like questions." Says a contemporary: "Howe was undaunted as a rock, and as silent, the characteristics of his whole race." "Howe never made a friendship except at the mouth of a cannon." Howe was thorough. His most important success was with a large fleet whose maneuvers he planned with great detail and completeness. He was a great tactician, but not so much of a fighter as Nelson. He was a rigid disciplinarian. Howe was patient, was without great personal ambitions, and never sought pension or remuneration.

Howe was fearless. To a lieutenant who came to him in perturbation saying "the ship is on fire close to the magazine; but don't be frightened, we shall get it under control shortly," Howe replied, "Frightened, sir! What do you mean? I never was frightened in my life." He was composed under suspense. Once in a stormy night, when there was danger of the ships running afoul of each other, a captain who had spent a sleepless night asked him how he had slept. Lord Howe replied that "he had slept perfectly well, for as he had taken every possible precaution he could before dark, he laid himself down with a conscious feeling that everything had been done which it was in his power to do for the safety of the ships . . . and this conviction set his mind at ease." The stimulus of impending battle, even at the age of 70, revived the fires of youth; he displayed an animation of which he would hardly have been thought capable at his age.

He felt deeply, as hypokinetics are wont to do; so he resented the treatment he had received while in America from the British ministry. His brother William, commander in chief of the British forces in America in the early part of the Revolution, resigned his command at about the same time with the same feeling.

His elder brother, George Augustus, ranked third in the naval list and was killed in the Ticonderoga expedition of 1758. Howe was a fighter, if necessary. He came of fighting stock, but he was at his best as tactician and administrator. His father was governor of the Barbados; his father and his father's father were members of Parliament.

#### FAMILY HISTORY OF RICHARD, EARL HOWE.

I 1 (F F F F), Sir Richard Grubham Howe. I 3 (F F M F), Emanuel Scrope, Earl of Sunderland.

II 1, Prince Rupert. II 3 (F F F), Sir John Howe. II 4 (F F M), Anabella Scrope, a natural daughter, who was afterwards legalised by an act of Parliament. II 5, John, Earl of Rutland. II 7 (F M F), Lord William Allington.

III 1, Ruperta, a natural daughter. *Fraternity of F F*: III 2, Emanuel Howe. III 3, John Howe, member of Parliament. III 4, Charles Howe. III 6, Lady Anabella. III 7 (F F), Scrope Howe (born 1648), was a member of Parliament and was created Baron Clenarolly and Viscount Howe. III 8 (F M), Juliana. III 9 (M F), Baron Kielmansegge. III 10 (M M), Countess of Darlington, mistress of George I.

IV 3 (F), Emanuel Scrope, second Viscount Howe, was a member of Parliament and in 1732 was appointed governor of the Barbados, where he died. IV 4 (M), Mary Sophia Charlotte. IV 5 (consort's F), Colonel Chiverton Hartop, of Walby.

*Fraternity of Propositus*: V 1, George Augustus, third Viscount Howe, was third on the naval list in the attack on the French in America. V 2, William, fifth Viscount Howe (died 1814), held the rank of lieutenant colonel general and was in command in America, but relinquished his command to General Clinton. V 3, — Howe, was "a clever, eccentric woman: well known in London society." V 4 (*Propositus*), RICHARD, EARL HOWE. V 5 (consort), Mary Hartop.

VI 1, Robert, sixth Earl of Cardigan. VI 2, Penelope Cooke. VI 3, Sir John Gore, admiral of the Royal Navy. VI 5, Hon. Penn Assheton Curzon. *Children of Propositus*: VI 6, Sophia

Charlotte Howe (1762-1835). VI 7, Sir Jonathan W. Waller. VI 8, Maria Howe. VI 9, Lord Altamont, Marquis of Sligo. VI 10, Louisa Catherine Howe. VI 11, Sir William Scott, Lord Stowell.

VII 1, George Anson (1797-1857), a major general; commander in chief in Italy. VII 2, Isabella Weld. VII 3, Harriet Georgiana, died 1836. *Children's children of Propositus*: VII 4, Richard William Penn Curson (1796-1870), Viscount Curson and first Earl Howe. VII 5, Anne Gore. VII 6, George Augustus Curson (1788-1806). VII 7, Marianne Curson, died 1830. VII 8, Brigadier General Halifax.

VIII 1, John Winston, seventh Duke of Marlborough (1822-1883), lord lieutenant of Ireland. VIII 2, Lady Frances Vane. VIII 3, Isabella Anson. *Children's children's children of Propositus*: VIII 4, George Augustus Curson (1821-1876), second Earl Howe, a lieutenant colonel of volunteers. VIII 5, Richard William Penn Curson, third Earl Howe (1822-1900), lord lieutenant of Leicester county, a colonel in the army. VIII 6, Frederick Curson (1825-1881), a captain in the Royal Navy. VIII 7, Henry D. Curson born 1824. VIII 8, William Henry Curson (born 1827), a major in the army; served in the Crimea and received a medal and clasp and a Turkish medal; won a medal in India. VIII 9, Sir Leicester Smyth (1829-1891), served in the Crimea; commanded troops in the southern district, 1889; governor and commander in chief, Gibraltar. VIII 10, Ernest George Curson (1828-1885), assistant adjutant and quartermaster general at Aldershot; deputy adjutant general in Ireland. VIII 11, Augusta Halifax. VIII 12, Montagu Curson (1846-1907), colonel in the army. VIII 13, Asheton

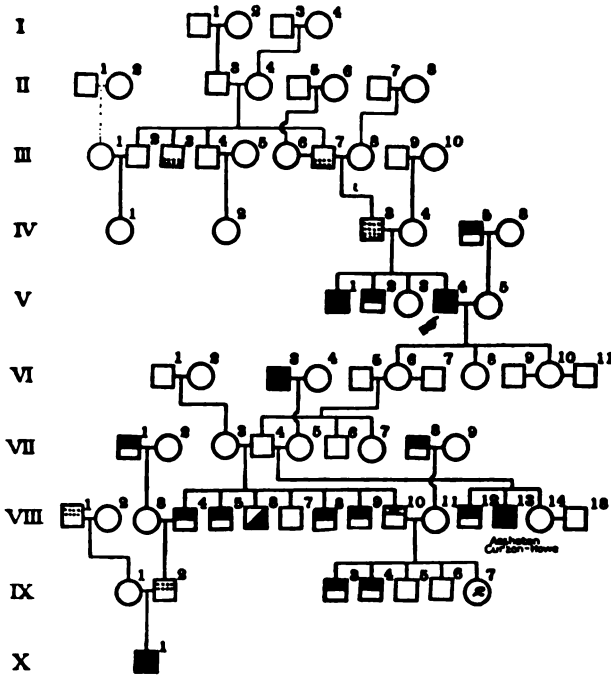

Gore Curson-Howe (born 1850), joined the Royal Navy as a cadet, 1863; made vice admiral 1905; K. C. B. 1905. VIII 14, Mary Anna Curson. VIII 15, James, second Duke of Abercorn. IX 1, Lady Georgiana Spencer Churchill. *Children's children's children's children of Propositus*: IX 2, Richard George Penn Curson-Howe, fourth Earl Howe (born 1861), a member of Parliament; treasurer of Her Majesty's household, lord chamberlain to Queen Alexandra. IX 3, Ernest C. Penn Curson (born 1856), a major of reserve of officers. IX 4, Fitz Roy Edmund Penn Curson (born 1859), a lieutenant colonel in the army; present at Khartoum and was specially mentioned in the dispatches; in the Sierra Leone expedition and in the South African war his work received special recognition. *Children's children's children's children's children of Propositus*: X 1, Francis Richard, Viscount Curson (born 1884), a commander in the Naval Reserve.

BIBLIOGRAPHY.

BARROWS, SIR JOHN. 1837. *The Life of Richard, Earl Howe, K. G., Admiral of the Fleet and General of Marines*. London: J. Murray.  
 BURKE, SIR B., and A. 1909. *A Genealogical and Heraldic History of the Peerage and Baronetage*. London: Harrison and Son. 2570 pp.

## 31. JOHN JERVIS.

JOHN JERVIS, ADMIRAL LORD ST. VINCENT, was born January 9, 1735, in Staffordshire, England. He entered the navy January 4, 1749, became lieutenant in 1755, and participated in the conquest of Quebec in 1759, being made commander the same year. During the next twelve or fifteen years he traveled somewhat widely through Europe, making professional notes. During the American Revolution he commanded in the English Channel, participated at Gibraltar, and was for years in Parliament. From 1793 to 1795, as vice admiral, he cooperated with the army in the conquest of the French islands in the West Indies. As Admiral, in 1795, he took command of the Mediterranean fleet, facing the allied fleets of France and Spain. In 1797, off Cape St. Vincent, he defeated the allies against heavy odds (in which affair Nelson won great honors), and was made Earl St. Vincent. His health having broken down, he resigned his command in 1799, but later took command of the Channel fleet and subsequently was, for some time, first lord of the admiralty. In 1810 he retired. He died in 1823. He had married his cousin, Martha Parker, who died childless, 1816.

The most striking traits that Jervis showed were the following:

*Self-reliance.* — His father wished him to follow law, but he preferred the advice of his father's coachman; and when he had once evinced his predilection for the sea no expostulations on the part of his parents could shake him. When his uncle got him placed, through the admiralty, on a guardship at the age of 13 years, he concluded that he should be going on some expedition of importance and volunteered for regular service. When he drew on his father for £20 and the draft came back protested, he says: "I immediately changed my mode of living, quitted my mess, lived alone, and took up the ship's allowance, washed and mended my own clothes, made a pair of trousers out of the ticking of my own bed." When he had leave on half pay he traveled over Europe to get a first-hand view of conditions. At sea he used his unlimited power, and would quell mutiny by hanging or flogging those of his men who offended him. His opinions of his officers were formed with great independence and held tenaciously. In action he showed resource in a moment of danger. As for himself he despised cant, prized independence, and was fearless in decision. As head of the admiralty he was a vigorous and thoroughgoing reformer and applied the same autocratic methods there that he had employed on shipboard.

*Administrative ability.* — Jervis was extremely industrious and a great organizer and disciplinarian. He studied hard, and had surprising aptitude and a fine memory for all branches of professional and general knowledge. He understood human nature and ruled his men "by a wise combination of prompt severity tempered by judicious clemency." To his discipline and his organization of his squadron the success of the battles of St. Vincent and, to a certain extent, Nelson's squadron at the Nile, were due. "The instant repair of any damages to the ships, whether caused by storm or battle, was almost a mania with him." In the admiralty he reformed notorious corruptions in the dockyards.

He was always energetic. When on half pay he went to France and nearly ruined his health in study to make up early deficiencies in his education. Again, in time of peace, he entered Parliament. At 71 years of age he took up with alacrity the command of the Channel fleet and carried out a naval campaign. It is said that he was extremely punctual in all his concerns, even the most trifling, and "answered every letter the moment he received it." His father also was a



good administrator and lawyer, was counsel to the admiralty, and auditor of Greenwich Hospital.

He had the slighter grade of hyperkinesis; was forcible, animated, humorous, quick, and determined; but dignified and patient in large matters.

FAMILY HISTORY OF JOHN JERVIS, VISCOUNT ST. VINCENT.

I 1 (M M M F), Colonel Samuel Moore, made a gallant defense of Hampton Castle in the old English wars and kept a diary of the siege. I 3 (M F M F), James Carrier. I 4 (M F M M), Elizabeth Parker, of Browsholme. I 5, Janet Parker. I 6, Charles Carrier.

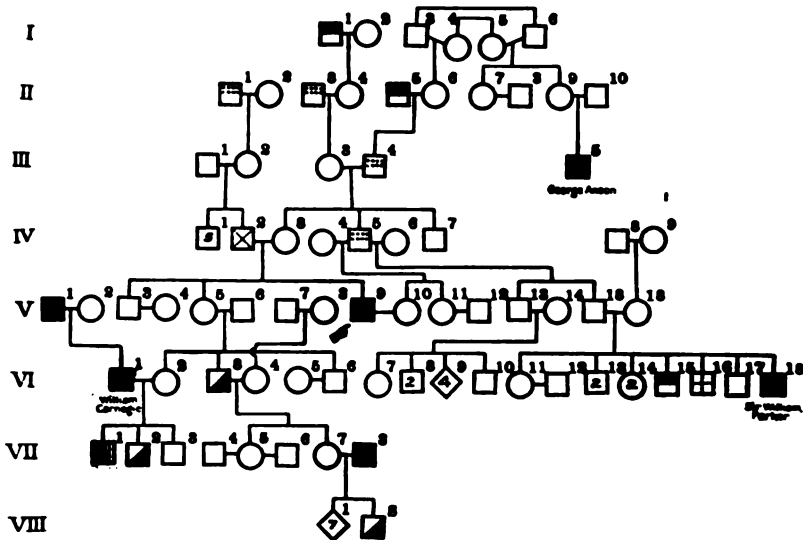

II 1 (F M F), John Swynfen, a noted member of Parliament; his plainness of demeanor gave him the name of "Russet Coat." II 3 (M M F), Sir John Turton, puisne judge in the court of the exchequer; afterwards in the king's bench. II 4 (M M M), Anne Moore. II 5 (M F F), William Parker, commanded a company of foot under Charles I; was also distinguished during the reign of Charles II. He was present at Marston Moor and Naseby. II 6 (M F M), Bridget Carrier. II 7, Janet Carrier. II 8, Thomas Parker, first Earl of Macclesfield; lord chancellor. II 9, Elizabeth (or Isabella) Carrier. II 10, William Anson.

III 1 (F F), John Jervis. III 2 (F M), Mary Swynfen. III 3 (M M), Margaret Turton. III 4 (M F), George Parker, of Stafford county, a justice of peace. III 5, George Anson, Baron Anson (1697-1762), entered the navy in 1712; in 1740 he was sent to attack Spanish possessions in South America, and while he was gone he circumnavigated the globe. Afterwards as a member of the admiralty board he did much to improve naval conditions; he rose to the rank of admiral and was known as the "Father of the British Navy."

IV 2 (F), Swynfen Jervis (1700-1784), counsel and solicitor to the admiralty; treasurer of Greenwich Hospital. IV 3 (M), Elizabeth Parker. *Fraternity of M*: IV 4, Martha Strong. IV 5, Sir Thomas Parker, chief baron of the court of the exchequer. IV 6, Anne Whitehall. IV 7, John Turton. IV 9, Mabella Swynfen.

V 1, George Carnegie, sixth Earl of Northesk, admiral of the white. *Fraternity of Propositus*: V 3, William Jervis (1728-1813), gentleman usher of the privy chamber. V 4, Jane Hatrell. V 5, Mary Jervis. V 6, William Henry Ricketts, bencher of King's Inn. V 7, Richard, Earl of Cavan. V 9 (*Propositus*), JOHN JERVIS, VISCOUNT ST. VINCENT. V 10 (consort), Martha Parker. *Fraternity of consort*: V 11, Laetitia Parker. V 12, Rev. Thomas Heathcote. V 13, Thomas Parker. V 14, Mary Hawe. V 15, George Parker. V 16, Elizabeth Turton.

*Fraternity of children of sib*: VI 1, William Carnegie (died 1831), rear admiral; was third in command at Trafalgar. VI 2, Mary Ricketts. VI 3, William Henry (Ricketts) Jervis (1764-

1805), became a captain in the Royal Navy and was drowned at sea. VI 4, Lady Elizabeth Jane Lambert. VI 5, Hon. Cassandra Twiselton. VI 6, Edward (Ricketts) Jervis, second Viscount St. Vincent. VI 7, Mary Parker. VI 8, Thomas and Robert Parker. VI 10, — Parker, died unmarried. VI 11, Elizabeth Parker. VI 12, John Nutthall. VI 15, Edward Parker, a captain of the Royal Engineers; killed 1814. VI 16, John Parker (died 1812), rector of St. George Botolph. VI 17, George Parker (died 1809), private secretary to Lord St. Vincent. VI 18, William Parker (died 1866), entered the navy in 1793 when 11 years of age; served with distinction and became naval commander in chief in China and India; in 1863 he was made admiral of the fleet.

*Fraternalities of children's children of sib:* VII 1, George Carnegie, Lord Rosehill, lost on board the *Blenheim* in his sixteenth year. VII 2, Swynfen Thomas Carnegie (born 1813), a captain of the Royal Navy. VII 3, — Carnegie, Earl of Northesk. VII 4, Lieutenant General Sir William Cockburn. VII 5, Martha Jervis. VII 6, Osborne Markham. VII 7, Henrietta Elizabeth Jervis. VII 8, Captain Edmund Palmer, of the Royal Navy; C. B.

VIII 2, John Jervis Palmer, became a lieutenant in the navy in 1843 and served on Sir William Parker's flagship in the East.

## BIBLIOGRAPHY.

- ARMYTAGH, G., and W. RYLANDS. 1912. *Staffordshire Pedigrees, etc.* London: Publications of the Harleian Society. Vol. lxxiii. 295 pp.
- ANSON, W. 1912. *Life of G. A. Anson, Admiral Lord Anson.* London: J. Murray. 202 pp.
- ANSON, W. 1913. *The Life of John Jervis, Admiral Lord St. Vincent.* London: J. Murray. xiii + 368 pp.
- BRENTON, E. 1838. *Life and Correspondence of John, Earl of St. Vincent, G. C. B., Admiral of the Fleet.* London: H. Colburn. 2 vols.
- MAHAN, A. 1913. *Types of Naval Officers drawn from the History of the British Navy.* Boston: Little, Brown and Co. xiv + 500 pp.
- O'BRYNE, W. 1849. *A Naval Biographical Dictionary, comprising The Life and Services of Every Living Officer in Her Majesty's Navy.* 1400 pp.
- PHILLMORE, A. 1876. *The Life of Admiral of the Fleet Sir William Parker.* 3 vols. London: Harrison.
- PITT, W. 1817. *A Topographical History of Staffordshire.* Newcastle-under-Lyme: J. Smith. xxvi + 319 pp.
- TUCKER, J. 1844. *Memoirs of Admiral the Right Hon. the Earl of St. Vincent.* London: R. Bentley. 2 vols.

## 32. CATESBY AP ROGER JONES.

CATESBY AP ROGER JONES was born in Clarke county, Virginia, about 1830. He became a midshipman under his father's brother, Thomas ap Catesby Jones, then in command of an exploring expedition. Later he served in the United States Coast Survey with Maury. He studied with Dahlgren. When his State seceded he went with her, in June 1861. At this time the Federal government abandoned the Norfolk Navy-yard, and as it did so burned or scuttled the naval vessels at the wharves. The new steam frigate *Merrimac* had been sunk and Lieutenant Jones was intrusted with the task of raising her. He also wholly reconstructed her so as to make an ironclad steam ram, rechristened the *Virginia*. When she was ready Jones was executive officer and third in command, Buchanan being captain. On the second day's engagement, that with the *Monitor*, both of his superiors were wounded and the command of the *Virginia* devolved upon Jones; but he could do nothing against the *Monitor*. He was superseded by Commodore Tatnall, who was unable to effect anything against the *Monitor*. Jones died in 1877.

Jones was a man of great purity of life and practice, quiet and firm, but very determined in time of danger. His work on the *Merrimac* puts him in the rank of great naval constructors. His pedigree clearly shows that he was of fighting stock.

## FAMILY HISTORY OF CATESBY AP ROGER JONES.

I 1 (F F F F), Colonel Thomas Jones (died 1758), had large plantations in Virginia. I 2 (F F F M), Elizabeth Pratt, daughter of William Pratt, a wealthy merchant. I 3 (F F M F), James Skelton. I 4 (F F M M), Jane Meriweather. I 5 (M F F F), John Page (born 1720). I 6 (M F F M), Jane Byrd.

*Fraternity of F F F*: II 3, Frederick Jones (born 1732), removed to North Carolina. II 4, William Jones (born 1734), went to sea before he was 16 years of age; he held some official positions in the colony. II 5, Walter Jones (born 1745), received his degree of doctor of medicine at the University of Edinburgh; was a member of Congress. II 6 (F F F), Colonel Thomas Jones (1726-1785-6), owned a large plantation; was clerk of Northumberland county court for years. II 7 (F F M), Sally Skelton. II 8 (F F M), John Tuberville. II 10 (M F M), Mary Mason Seldon. II 11 (M F F), Mann Page (born 1742). *Fraternity of M F F*: II 12, John Page, was a member of Phi Beta Kappa. II 13, Elisabeth Burwell.

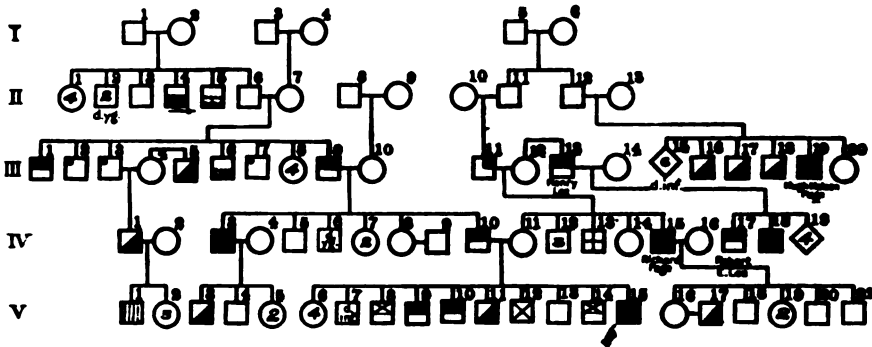

*Fraternity of F F*: III 1, Thomas ap Thomas Jones, was a major in the Revolutionary war, acting as recruiting officer. He owned a schooner which was largely used for pleasure excursions. III 2, Jekyll Jones, a political writer of some note. III 3, Meriweather Jones (born 1766), was a lawyer and a distinguished political writer and leader of Richmond. He was said to have eloped at 17; he engaged in many duels and was finally killed in one. III 4, Lucy Franklin Reed. III 5, Franklin Reed, of the United States navy. III 6, Bathurst Jones, a member of the Virginia assembly. There is a tale that he took his life because of his wife's jealousy. III 7, Skelton Jones, a lawyer and editor; was the participant in many duels and the number of men he had killed made him morose and remorseful; he was finally killed in a duel. III 9 (F F), Major Catesby Jones, a high-spirited, cultured gentleman and an active, energetic business man. III 10 (F M), Lettice Corbin Tuberville. III 11 (M F), William Byrd Page (born *ca.* 1768), was a planter; he was appointed assistant inspector of ordnance. III 12 (M M), Anne Lee, born 1776. *Fraternity of M M*: III 13, Henry Lee (1756-1818), known as "Light Horse" Harry Lee. He received a gold medal from Congress for his distinguished gallantry during the Revolutionary war. III 14, Anne Hill Carter. III 16, Octavius Augustus Page (1765-1813), a lieutenant in the United States navy, served on the *Chesapeake*. III 17, Peyton Randolph Page (born 1776), was in the United States navy and captured by the British. III 18, Lewis Burwell Page (1778-1826), a sailing-master in the United States navy. III 19, Hugh Nelson Page (born 1788), entered the United States navy as a midshipman in 1811. He volunteered for Perry's squadron, taking an active part in the battle of Lake Erie. He was voted a sword by Congress for his gallantry. He served in various capacities in South American waters, in the Levant, and on the Pacific coast, retiring with the rank of captain in 1855. III 20, Jane Page.

IV 1, Walter Jones, an officer in the United States navy. IV 2, — Taylor, of Norfolk, Virginia. *Fraternity of F*: IV 3, Thomas ap Catesby Jones (1789-1858), entered the navy in 1805 and rose to the rank of captain in 1829. He engaged in suppressing piracy, smuggling, and the slave-trade in the Gulf of Mexico, 1808-1812. In 1814 he attempted with a small flotilla to intercept a British squadron of 40 vessels but was obliged to surrender. IV 4, Mary Walker Carter. IV 5, Philip de Catesby Jones (born 1792). IV 10 (F), Roger Jones (1788-1852), was appointed second lieutenant of marines in 1809 and in 1812 was transferred to the artillery with the rank of captain. He was breveted major for his services in the battles of Chippewa and

Lundy's Lane. In 1825 he was appointed adjutant general and finally reached the rank of major general. He was a man of strong character and independent nature; aggressive and courageous. IV 11 (M), Mary Ann Mason Page. *Fraternity of M*: IV 13, Charles Page, a clergyman. IV 15, Richard Lucian Page (born 1807), entered the United States navy in 1824 and served continuously until the Civil War, reaching the rank of commander. At the outbreak of the war he joined the Confederate States navy, was promoted to captain, and established an ordnance construction depot in North Carolina. Later he had charge of the outer defenses of Mobile Bay, and was promoted to the rank of brigadier general. After the war he was appointed superintendent of the public schools in Norfolk, Virginia. He was actuated by a strong sense of duty and his simple uprightness of life made him greatly beloved. His nephew, the propositus, has many points of similarity with him. IV 16, Alexina Taylor of Norfolk, Virginia. IV 17, Robert E. Lee (1807-1870), the commander in chief of the Confederate army. IV 18, Sidney Smith Lee (1802-1869), was appointed a midshipman in the United States navy and commanded his own vessel in the war with Mexico. He rose to the rank of commodore, having been commandant of the United States Naval Academy at Annapolis and chief of the Bureau of Coast Survey. At the outbreak of the Civil War he offered his services to the Confederate States navy and became chief of orders and details at Richmond.

V 1, Walter Jones, of the United States navy, died 1855. V 3, Meriweather P. Jones, a lieutenant in the United States navy. V 4, Marck C. Jones. *Fraternity of Propositus*: V 8, Eusebius Jones (1827-1876), in 1852 settled in New York to practice medicine, but in 1873 he removed to California, where he died. During the Civil War he had charge of a large government hospital on David's Island, near New York City. V 9, William Page Jones, was graduated from West Point among the first of his class. He became a lieutenant and was killed at Fort Henry, near Baltimore. V 10, Walter Jones became a lieutenant in the United States army, but upon the outbreak of the Civil War he joined the Confederate forces. V 11, Charles Lucian Jones, became an officer in the Confederate States navy. After the war he carried on a commission business in Georgia. V 12, Thomas Skelton Jones (born 1837), served in the United States navy for three years as clerk to his uncle, Commander R. L. Page. He was admitted to the bar. During the Civil War he became a captain in the Confederate States army and afterwards followed mercantile pursuits in various states. V 13, Winfield Scott Jones, went to California when a mere youth and became vice president of the Security Savings Bank of San Francisco. V 14, Roger Jones, was graduated from West Point and became inspector general in the United States army with the rank of brigadier general. V 15 (*Propositus*), CATSBY AP ROGER JONES. V 16, Fanny Page. V 17, Captain Whittle, United States navy. V 18, William B. Page, a mining engineer. V 19, Alexina and Edmonia Page. V 20, Walter Page, an analytical chemist who removed to Nebraska. V 21, Thomas S. Page, a physician.

## BIBLIOGRAPHY.

- JONES, L. H. 1891. Captain Roger Jones of London and Virginia. Albany: J. Munsell's Sons. 295 pp.
- LEE, E. 1895. Lee of Virginia. Philadelphia: Franklin Printing Co. 586 pp.
- PAGE, R. 1893. Genealogy of the Page Family in Virginia. 2d ed. New York: Press of the Publishers' Printing Co. x + 275 pp.
- SCHARF, J. 1894. History of the Confederate States Navy. Albany: J. McDonough. pp. 553-554, 710-711.

## 33. JOHN PAUL JONES.

JOHN PAUL JONES was born as John Paul at Kirkbean, Kirkcudbright, Scotland, July 7, 1747. After a meager education he was apprenticed, at the age of 12, to a merchant in the American trade, and in this capacity visited Virginia and while there stayed with his brother William. On the failure of his employer, John was appointed a British midshipman and later served on two slavers, passing rapidly from third to first mate. In 1768 he abandoned this business in disgust and remained stranded in Jamaica, where he accepted a temporary position as actor in the company of John Moody. This did not appeal to him, and he started back to Scotland as a passenger on the *John*. During the passage both officers died, Paul brought the vessel into port, and for this service was made master. Between 1766 and 1770 he made commercial voyages. In the latter year a sailor whom he formerly had flogged for insubordination died and John Paul was held responsible. His firm dissolved and he was thrown out of employment. He entered into trade on his own account and was accused of smuggling. In 1773 his crew mutinied and he unfortunately killed a man, and fled, entering "upon a truly melancholy period of homeless and nameless wandering" from June 1773 to the winter of 1775. He fled from Tobago under an assumed name and, unable openly to claim his rightful property, he emerged as John Paul Jones, a regularly appointed officer in the American army. Later he refers to himself as during this period a "son of fortune." It was during the latter part of this period that he is said to have fallen into a condition of dangerous melancholy. In December 1775 John Paul Jones was commissioned first lieutenant in the Continental navy. As commander first of the *Providence* and then of the *Alfred* he attacked New Providence, and damaged British shipping and fisheries in the North Atlantic; in October 1776 he was made captain, though he felt he deserved a higher rank. In November 1777 he sailed from France in the sloop *Ranger* with dispatches for the American commissioners asking that Jones be supplied a swift frigate in which to harass the coasts of England. He failed to get the frigate and so sailed in the *Ranger* from Brest (April 10, 1778), and two days later surprised the garrison of the forts at Whitehaven, spiking the guns and attempting to fire the shipping. Four days later he encountered the British sloop-of-war *Drake*, somewhat superior to his own, and defeated it. In this cruise Jones landed a party at St. Mary's Isle to capture Lord Selkirk. Failing in this, his crew took a quantity of plate from the Selkirk house and sold it; but this Jones later redeemed and returned to its owner. With the rank of commodore he was now put at the head of a squadron of 5 ships, his flagship being the *Bon Homme Richard*. He set sail, August 1779, with his fleet and 2 French privateers, but the latter and 3 of his men-of-war deserted him in the cruise. He captured prizes, and finally the *Bon Homme Richard* and *Pallas* captured the powerful British men-of-war *Serapis* and *Countess of Scarborough*. During 1780 Jones spent much of his time in Paris, where royalty made much of him. In 1781 he returned to America to be given a new command, but peace was soon restored. Two years later he was sent to Paris to collect prizes for the ships he had captured. Here he engaged much in social affairs and even private enterprises, but fulfilled his mission well. In 1788 he entered the service of the Empress Catherine of Russia as rear admiral. He engaged in naval battles against the Turks, but his enemies later forced him to remain in idleness in St. Petersburg while they assailed his private character. He returned to Paris in 1790 and died there, 1792, of dropsy, at the age of 45 years.

The elements that determined the successful vocation of John Paul Jones were:

*Nomadism.* — While yet a child it was his custom to wander off to the Carse-thorn at the mouth of the river Nith, where he listened to the stories of the mariners. The village legends of his native town bear witness to his early talent for seamanship while he was more child than boy. At school he was proficient in his studies, but showed a roving spirit, an active imagination, and promise of unusual independence. Throughout his life inactivity led to irritation and eventually to illness.

*Hyperkinesis and hypokinesis.* — Jones showed periods of vast reckless energy, but also at times deep depression. The hyperkinesis is shown in his enthusiasm, which awakened the same state in others. "He was delighted with his crew, who were equally devoted to him" (de Koven, 1913, p. 125). It is shown in his tremendous activity, especially in action. "In the rapture of the strife he was, like Nelson, gay in demeanor and ideal in command" (1913, p. 427). His hyperkinesis was associated with initiative and courage. He was the first to see an opportunity and the first to avail himself of it. It also led to free expression of opinion and feelings and his "white-hot anger." The pleasure of doing and of succeeding fed his ambition, "the first and ruling passion" of his life. "This ambition, abnormal in its intensity, was the motive power which determined his career. While yet of tender years he abandoned his position in the Royal Navy for lack of opportunities for quick advancement. This same ambition, combined with great capacity, procured him the position of mate and commander of trading-vessels while he was still exceedingly youthful; and after disastrous adventures and reverses brought about his astonishing advancement to his conspicuous place in the United States navy."<sup>1</sup> He was adventuresome, as when in the *Ranger* he captured the *Drake*, a ship more powerful than his own. "He commanded a vessel disguised as a merchantman; he made sudden and stealthy midnight descents upon their vessels and their ports; his method of warfare, brilliantly skillful as it was, had a coolness and a daring unexpectedness which recalled the legends of the early Vikings."

His depression was no less marked and was evidenced at the time of his seclusion, 1773-1775. At the time (1777) when he was waiting for arrangements to be completed that he might sail for France "he became again a prey to tormenting reflections" (p. 220). In 1783 he left America in a mood of depression; in general, says his biographer, "he was dangerously prone to brood over his misfortunes." "This tendency was a natural and inevitable concomitant of the mind of genius and, as has been seen, nearly overwhelmed him in the long period of melancholy retirement which followed the mutiny at Tobago." "He was never again free, except for brief intervals, from a disposition to dwell upon his misfortunes."

Jones had little erotic control, like many another hyperkinetic. He had an inclination toward feminine society which was greatly aided by his engaging personality. "During his second long residence in Paris it had been fully indulged in. It is thought that a son was born to him at this time"<sup>2</sup> (p. 279). A contemporary writes: "He is said to be a man of gallantry and a favorite among the French ladies, whom he is frequently commending for the neatness of their persons, their easy manners, and their taste in dress." Apparently he came under the seductive influence of Catherine of Russia.

At times Jones showed a combination of self-esteem and suspicion, amounting almost to paranoia. "Ambition, working unhindered upon his immensely

<sup>1</sup> De Koven, 1913, p. 327.

<sup>2</sup> De Koven, p. 293.

<sup>3</sup> De Koven, 379.

vigorous imagination, built the delusion of an aristocratic extraction upon circumstantial evidence, wholly devoid of definite facts. From his self-love and burning determination to force his own valuation of himself into public recognition grew the extraordinary conception of carrying off his supposed father (Lord Selkirk) as a captive. From the height to which his untrammelled fancy had raised him he announced himself as the impartial defender of the insulted rights of human nature, declaring himself 'totally unfettered by the little mean distinctions of climate or of country.' His attitude of confirmed suspicion toward the United States and its officials was of the same type.

Of his heredity, little can be said. His mother is not described. What is known of his family is shown on the chart.

#### FAMILY HISTORY OF J. PAUL JONES.

I 1 (F) — Paul, kept in Leith, Scotland, a "mail garden," a combination of tavern and market garden. I 3 (M F). — McDuff, a "free landholder."

Progeny of P: II 1, George Paul, a landscape gardener at St. Mary's Isle. II 2 (F), John Paul, a landscape gardener in Leith. II 3 (M), Jossie McDuff.

Progeny of P: III 1, William Paul, departed for America, early in life. II 2, Elizabeth Paul, died unmarried. III 3, Joan Paul. III 4, Mr. Taylor, a watchmaker in Dumfries. III 5, Mr. Young. III 6, Mary Ann Paul. III 7, Mr. Lowden. III 9 (Progeny), JOHN PAUL JONES.

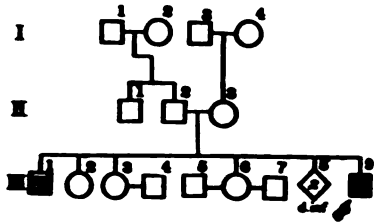

#### BIBLIOGRAPHY.

DE KOVEX, Mrs. R. 1913. *The Life and Letters of John Paul Jones*. New York: C. Scribner's Sons. 2 vols.

#### 34. HENRY KEPPEL.

HENRY KEPPEL was born June 14, 1809. He studied at the naval academy at Portsmouth and entered the navy in 1822; he reached the rank of commander in 1833. He was engaged in suppression of the slave trade and did service in the China sea against Malay pirates. At the siege of Sebastopol he commanded a naval brigade and won renown in the operations around that fortress. Sent to China in command of the *Raleigh*, he lost his ship on a rock, but in three small vessels with his crew he fought the Chinese at Fatshan Creek (1857) and was knighted for his success. He was made admiral in 1877 and died 27 years later, at the age of 95. He wrote his autobiography.

Keppel was a hyperkinetic. He was high-spirited, had a personal enthusiasm, a magnetic personality, and an infection of geniality. In battle he had the pugnacity of a bulldog and showed reckless daring. He was of the Albemarle tribe. His brother, the sixth earl, was a general, who served in the Waterloo campaign, at Mauritius, the Cape, and India, and was also a great traveler. Their father was a lover of racing, like his son Henry. Henry disliked funerals and broke out of the military procession held at his brother's death.

He was literary. He wrote two books, later combined in his autobiography. His brother, the earl, wrote an account of his travels.

His naval career was advanced by his social position. Many of the Albenmarks were generals or naval officers. He himself became an admiral; his brother Tom went into the navy as a youngster, but later became a clergyman and has a son who is a rear admiral. A son, Colin, is a distinguished naval officer who saw service on the Nile and was made rear admiral in command of the Atlantic fleet in 1909.

FAMILY HISTORY OF HENRY KEPPEL.

I 1 (F F F M F), Adam van der Duyn, governor of Bergen op Zoom, and a major general in the Dutch service. I 3 (F F M F F), Charles II, king of England. I 4 (F F M F M), Louise de Kéroualle, Duchess of Portsmouth, mistress of Charles II; a woman of great cleverness and strength of will.

II 1 (M F M F), Edward Watson, Viscount Sondes. II 2 (M F M M), Catherine Tufton. *Fraternity of M F M M*: II 3, Lady Margaret Tufton, haughty and ruled her household with a rod of iron. II 4, Thomas Coke, Earl of Leicester (born 1697), "achieved celebrity for his fine taste in art and literature," but was passionate and cruel. II 5 (F F F F), Arnold Joost van Keppel (born in Holland, 1670), attended King William into England, 1688; he was created Baron Ashford and Earl of Albemarle. He returned to Holland, where he became commander in chief of the Dutch army. High-spirited. II 6 (F F F M), Gertrude van der Duyn. II 7 (F F M F), Charles Lennox, first Duke of Richmond (1672-1723). II 8 (F F M M), Anne Brudenel.

III 1 (M F F), Edward Southwell, Viscount Sondes. III 2 (M F M), Catherine Watson died 1765. III 3 (M M F), Samuel Campbell. III 5, Edward Coke (1719-1783), led a life of debauchery, extravagance, and excess, and died from his excesses. III 6 (F M F), Sir John Miller of Hants. III 8 (F F F), William Anne Keppel, second Earl of Albemarle (1702-1754) at the age of 15 was appointed to the rank of a lieutenant colonel in the army. In 1748 he was made commander in chief of the British forces serving in the Low Countries. In 1749 he was appointed ambassador at Paris and remained at this post until his death. III 9 (F F M), Lady Anne Lennox. *Fraternity of F F M*: III 10, Charles Lennox, second Duke of Richmond (1701-1750), was a "soldier of distinction." III 11, Lady Sarah Cadogan. III 12, John Russell, fourth Duke of Bedford (1710-1771), first lord of the admiralty and secretary of state for the southern department.

IV 1 (M F), Sir Edward Southwell, Baron de Clifford (1732-1777), was sheriff of the county of Gloucester and member of Parliament. IV 2 (M M), Sophia Campbell (died 1828). She was governess to Princess Charlotte of Wales. She was a very intelligent, lively woman, full of anecdote, and of great personal courage, who when over 80 discharged her pistols at thieves climbing over the garden wall. *Fraternity of F M*: IV 5 (F M), Anne Miller, was a formal, not very good-tempered woman who was "not attractive to her grandchildren." IV 6 (F F), George Keppel, the third Earl of Albemarle (1724-1772), served in the army under the Duke of Cumberland at Fontenoy and Culloden and carried dispatches of the victory of Culloden to the king. He was commander in chief of the celebrated Cuban expedition at the reduction of Havana in 1762 and was created K. G. in 1765 in recognition of his services. *Fraternity of F F*: IV 7, Augustus Keppel (1725-1784), went to sea at 10 years

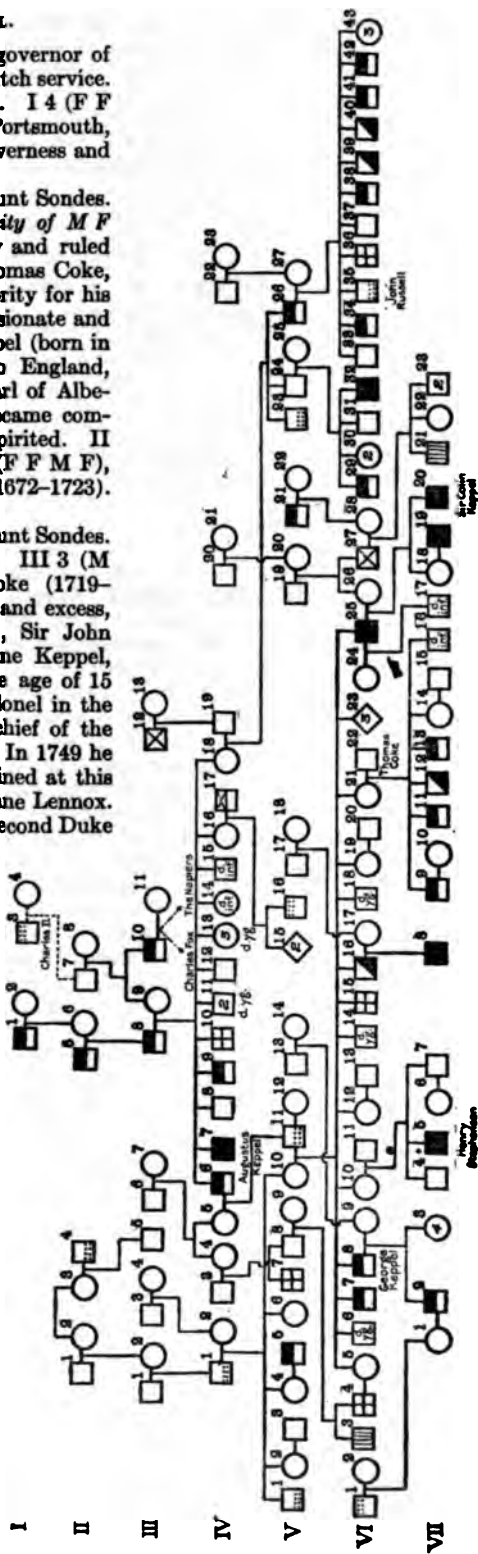



was commander at the age of 22. He won a treaty from the dey of Algiers, after many difficulties. In the battle of Quiberon his ship was the first to get into action. His later years were embittered by suspiciousness and quarrelsomeness, and though for a time he was first lord of the admiralty, his popularity soon disappeared entirely. IV 9, William Keppel (1727-1782), was a lieutenant general and commander in chief in Ireland, 1773. IV 10, Frederick Keppel (1723-1777), was bishop of Exeter and dean of Windsor. IV 16, Lady Caroline Keppel (born 1737 and died in childbirth), is thought to have composed the ballad "Robin Adair" when her family would not consent to her marriage. IV 17, Robin, or Robert, Adair (born 1790), became inspector general of military hospitals and then royal staff surgeon and surgeon of Chelsea hospital. IV 18, Lady Elizabeth Keppel (died 1768), a very beautiful woman; she was one of the bridesmaids of Queen Caroline. IV 19, — Russell, marquis of Tavistock, who was killed while out hunting at the age of 22. IV 20 (second consort's M F), Robert Walpole, second Earl of Orford (1701-1751). IV 21 (second consort's M M), Margaret Rolle.

*Fraternity of M:* V 1, Edward Southwell, Baron de Clifford (1767-1832), member of Parliament. V 2, Sophia Southwell. V 3, John Thomas Townshend, Viscount Sydney. V 4, Catherine Southwell (died 1802). V 5, Colonel George K. Coussmaker. V 7, William Garnier, prebendary of Winchester Cathedral. V 8, Dr. Thomas Garnier, Dean of Winchester. V 10 (M), Elizabeth Southwell (1776-1817), was not yet 16 years of age when she married, and one of her early bride exploits was sliding down the banisters and having her head trepanned in consequence. V 11 (F), William Charles Keppel, fourth Earl of Albemarle (1772-1849), was appointed master of the horse in 1830; was a member of Parliament. V 12 (F's second consort), Charlotte Hunloke. V 13, Sir Coutts Trotter. V 16, Sir Robert Adair, a distinguished diplomat who died in 1844, aged 80 years. V 17, Sir Thomas Lennard. V 19 (second consort's F), Martin J. West. V 20, Maria Walpole. V 21, Captain Hon. George Barrington. V 23, Francis Russell, fifth Duke of Bedford (1765-1802), became a leader in the House. V 24, William Russell (born 1767), lived abroad at Geneva. V 25, Charlotte Anne Bussy. V 26, John Russell, sixth Duke of Bedford (1766-1839), lord lieutenant of Ireland. V 27, Georgiana Elizabeth Byng.

VI 1, Hon. Sir Alan Napier M'Nabb, first and last British premier of Canada. VI 3, George Garnier, studied at the Royal Naval College. In 1822 he sailed for the Cape of Good Hope and was never heard of again. VI 4, Thomas Garnier, Dean of Lincoln. *Fraternity of Propositus:* VI 5, Caroline Keppel (died 1898), a sensitive child, but popular as a young woman; of charming personality, prompt in action and a great walker. VI 7, Augustus Frederick, fifth Earl of Albemarle (1794-1851), served in the Peninsular war with the Foot Guards. In later life he became eccentric and had to be placed under restraint; believed himself possessed of unbounded wealth. A post-mortem examination revealed a fracture of the skull. VI 8, George Thomas Keppel, sixth Earl of Albemarle (1799-1891), took part in the Waterloo campaign. He served in Africa and India and returned to England in 1823, traveling overland through Persia, Moscow, and St. Petersburg. He visited the seat of the Russo-Turkish war in 1829 and was with the British fleet in Turkish waters; rose to the rank of general, wrote books of travel. VI 9, Susan Trotter. VI 10, Mary Keppel (died in 1884, aged 80 years); was a great walker. VI 11, Henry Stephenson (died 1850). VI 12, Sophia Keppel (died 1824). VI 13, Sir James MacDonald. VI 14, Charles Keppel (1805-1817), killed in a shooting accident. VI 15, Edward Southwell Keppel (1800-1883), rector of Quidenham and canon of Norwich. VI 16, Thomas Robert Keppel (1811-1863), studied at the naval college, but later became rector of North Creake and honorary canon of Norwich. VI 17, Frances Lennard. VI 18, John Keppel (1815-1823). VI 19, Georgiana Charlotte (died 1854). VI 20, Edward E. Hill. VI 21, Anne Amelia Keppel (died 1844). VI 22, Thomas Coke, first Earl of Leicester (1754-1842), a famous agriculturist. VI 24 (first consort), Catherine Crosbie (died 1859). VI 25 (*Propositus*), HENRY KEPPEL. VI 26 (second consort), Jane Elizabeth West. *Fraternity of second consort:* V 27, Rt. Hon. Sir Algernon West (born 1832), was a clerk in the admiralty; was secretary at the India office and to Mr. Gladstone when he was prime minister. VI 28, Mary Barrington. *Second cousins of Propositus:* V 29, Francis Russell (1793-1832), a lieutenant colonel in the army. VI 32, John Russell (1796-1835), a commander of the Royal Navy. VI 33, Francis Russell, seventh Duke of Bedford (1788-1833). VI 34, George William Russell (1790-1846), a major general in the army, sometime envoy extraordinary and minister plenipotentiary at Berlin, and aide-de-camp, to Queen Victoria. VI 35, John Russell (1792-1878), created Earl Russell; sat in the House of Commons 47 years; a distinguished statesman, orator, and writer; fond of travel. VI 36, Wriothesley Russell (1804-1886), rector of Chenies, Bucks, and canon of Windsor. VI 37, Edward Russell (1805-1887), C. B.; an officer of the Legion of Honor. VI 38, Charles James Fox (1807-1894), formerly in the army; sergeant at arms, House of Commons. VI 39, Francis John Russell (1808-1869),

a captain of the Royal Navy. VI 40, Henry Russell (1816-1842), a captain in the Royal Navy. VI 41, Cosmo George Russell (1817-1875), a major in the army. VI 42, Alexander George Russell (1821-1907), a general in the army.

*Children of fraternity of Propositus and consorts:* VII 1, Sophia Mary M'Nabb. VII 2, William Coutts Keppel, seventh Earl of Albemarle (1832-1894), became an ensign, but retired from the army in 1853. He was a member of Parliament, superintendent of Indian affairs for Canada, and treasurer of the Queen's household. VII 4, Augustus Stephenson. VII 5, Henry Stephenson (born 1842), entered the Royal Navy in 1855 and retired in 1904 with the rank of admiral. VII 7, Sussex Stephenson. VII 8, Leicester Chantrey Keppel, a midshipman on the *H. M. S. Bellerophon* in 1854, served continuously and with distinction, retiring as a rear admiral. VII 9, Thomas William Coke, second Earl of Leicester (born 1822), became lord lieutenant of Norfolk and keeper of the privy seal. VII 10, Juliana Whitbreak. VII 11, Edward Coke (1824-1889), a captain in the army, member of Parliament, and high sheriff of Derbyshire. VII 12, Henry John Coke (born 1827), entered the Royal Navy and served in China, 1840-1842; has written books of travel. VII 13, Wenman C. Coke (1828-1907), served in Crimea as aide-de-camp to Lord Rokeby. *Children of Propositus:* VII 17, Rufus Keppel, born 1839. VII 18, Mary Keppel, born 1865. VII 19, Frederick T. Hamilton (born 1856), a rear admiral of the Royal Navy. VII 20, Sir Colin Keppel (born 1862), was educated on *H. M. S. Britannia*, 1775, and became rear admiral; 1909-1910, in command of the Atlantic fleet; C. B. 1898; K. C. V. O., 1908. VII 21, Gilbert West, entered the navy, but died early.

## BIBLIOGRAPHY.

- ALBEMARLE, EARL OF. 1876. *Fifty Years of My Life*. London: Macmillan & Co. 2 vols.
- BURKE, SIR B., and A. A *Genealogical and Heraldic History of the Peerage and Baronetage*. London: Harrison and Sons. 2570 pp.
- CLIFFORD, A. 1817. *Collectanea Cliffordiana in Three Parts*. Paris: M. Nouzon.
- GIBBS, V. 1912. *Complete Peerage of England, Scotland, Ireland, Great Britain and the United Kingdom*, ed. by G. E. C. London: G. Bell & Sons. Vol. II.
- KEPPEL, HON. SIR H. 1899. *A Sailor's Life under Four Sovereigns*. London: Macmillan & Co. 3 vols.
- KEPPEL, HON. & REV. THOMAS. 1842. *The Life of Augustus Viscount Keppel. Admiral of the White*. London: H. Colburn. 2 vols.
- STIRLING, A. 1908. *Coke of Norfolk and his Friends*. London: J. Lane. 2 vols.
- STIRLING, A. 1916. *A Painter of Dreams*. London & New York: J. Lane. xvi + 366 pp.
- WALPOLE, S. 1889. *The Life of Lord John Russell*. London: Longmans, Green & Co. 2 vols.
- WEST, A. 1905. *Memoir of Sir Henry Keppel*. London: Smith, Elder & Co. 186 pp.

## 35. JAMES LAWRENCE.

JAMES LAWRENCE was born at Burlington, New Jersey, October 1, 1781, passed through grammar school, and in 1798 was appointed a midshipman. In 1801 he went to Tripoli in the *Enterprise* and remained there for five years. From 1808 to 1812 he commanded various naval vessels. After the outbreak of the War of 1812 he wrought some destruction on the enemy's ships in the West Indies. Ordered to the command of the *Chesapeake*, he accepted a challenge to battle made by the British frigate *Shannon*. The *Chesapeake* was a poor ship. After a few broadsides the ships fouled and Lawrence received a musket ball in the leg and later in the abdomen. As he was carried below he cried, "Don't give up the ship"; but the enemy had already boarded it. Captain Lawrence died in a few days, June 6, 1813. The loss of this young officer was regarded as a keen blow to the national defense.

The elements of Lawrence's character were:

*Love of the sea.* — "While still a boy he longed to go to sea," but his father opposed, wanting him to become a lawyer. But when his father died he, at 18, began a theoretical course in navigation with his brother's aid.

*Fearlessness.* — His courage was of the highest order; he accepted battle with his inferior ship against a superior. He was calm in action.

*Hyperkinesis.* — He was high strung and sensitive, quick and impulsive, but in all critical situations his coolness was remarkable. He inspired all with ardor and was a general favorite with his men. When a coordinate was promoted over his head he protested first to the naval board, then to the United States Senate, and won his case. He was chivalrous, generous, just, kind of heart, gentle, and pure. Physically he was nearly six feet tall and very broad-shouldered.

James Lawrence had a sister Mary, who married Robert Boggs and bore a son, Charles S. Boggs. He entered the navy as a midshipman in 1826, served with distinction in the Mexican and Civil Wars, and died a rear admiral. He was courteous and mild, but strict in the enforcement of discipline. During the Civil War he was in command of the *Varuana*, attached to Farragut's fleet. This, the first ship to force its way past the batteries protecting New Orleans, was rammed by a Confederate ironclad and sunk. For gallantry in this action Boggs was voted a sword by his native State of New Jersey. In July 1862 he was placed in command of the *Sacramento*, of the blockading squadron off the Cape Fear river. On account of ill-health he was on shore duty during 1864-1865 and superintended the building and fitting out of a fleet of picket steamboats planned by himself.

James Lawrence's father was John Brown Lawrence, of Burlington, New Jersey, who was a lawyer, a staunch loyalist, a member of the council, and regarded by his townspeople as a man of importance. He was mayor of Burlington in 1775. He was a man of courage. He met the Hessians and prevailed on them to spare the town and later succeeded in stopping the firing of an American man-of-war when it was thought that Burlington was in the hands of the British. Arrested as a loyalist, he finally settled in Canada and died there in 1796. In the direct line of ancestors there are merchants and a major.

James Lawrence's mother, Martha Tallman, of Trenton, New Jersey, died when the propositus was an infant; nothing is recorded of her traits.

## FAMILY HISTORY OF JAMES LAWRENCE.

I 1 (F F F), Elisha Lawrence (born 1686), was a merchant on the south side of Raritan bay, New Jersey. I 2 (F F M), Lucy Stout.

II 1 (F F), Elisha Lawrence. II 3, Samuel Leonard, of Perth Amboy, New Jersey.

III 1 (consort's F), — Montaudevert, a French sea-captain, who was lost off the Scilly Islands. III 5 (M), Martha Tallman, of Trenton, New Jersey. III 6 (F), John Brown Lawrence, a lawyer of note and, in 1775, mayor of Burlington, New Jersey. He was arrested as a loyalist and finally went to Canada, where he died. III 7, Ann Leonard.

IV 1 (consort) Julia Montaudevert.

IV 2 (*Propositus*), JAMES LAWRENCE.

*Fraternity of Propositus*: IV 3, Sarah Lawrence.

IV 4, James Goellette. IV 5,

Katherine Lawrence. IV 6, Jackson

Brown French. IV 7, Anne Lawrence.

IV 8, John Parker. IV 9, Mary Law-

rence. IV 10, Robert Boggs. *Half*

*fraternity of Propositus*: IV 11, Eliza-

beth Lawrence, better known as "Ma-

dame Scribblerus," a woman of poetical and literary ability. IV 12, Michael Kearney, an Irish

gentleman of great social prominence.

*Children of Propositus*: V 1, Mary Lawrence, a beautiful and accomplished woman, who

died in Italy, 1843. V 2, William Preston Griffin, of the navy. V 3, — Lawrence, a post-

humous son, who died in infancy. V 4 (sister's child), Charles S. Boggs, entered the navy as

a midshipman in 1826, served with distinction in the Mexican and Civil wars and died a rear

admiral in 1888. V 5 (half-sister's child), Lawrence Kearney, died a commodore in 1868.

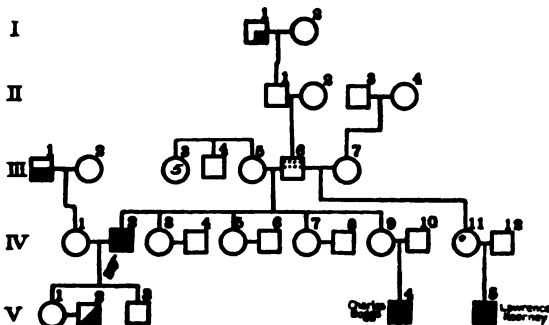

## BIBLIOGRAPHY.

GLEAVE, A. 1904. James Lawrence, Captain United States Navy. Commander of the *Chesapeake*. New York and London: G. P. Putnam's Sons. 337 pp.

## 36. THOMAS MACDONOUGH.

THOMAS MACDONOUGH was born in Newcastle county, Delaware, December 23, 1783. At the age of 17 years he received a midshipman's warrant and served on the *Philadelphia*, but was not captured when she was lost to the Moors. Later he was in the *Enterprise* under Captain Stephen Decatur. His bravery as one of a party under Decatur that recaptured and destroyed the *Philadelphia* received special commendation. At 24 years he was made lieutenant and 6 years later master commander. At the outbreak of the War of 1812 he was stationed at Lake Champlain. In the summer of 1814 a British fleet carrying about 95 guns and 1,000 men, supported by a land force of 1,500, attacked his fleet of 80 guns and 850 men. The British were defeated. It is said that, though commanding the fleet, Macdonough insisted on pointing his favorite gun, "putting his mathematical knowledge to the closest test and invariably making a death blow." As a reward he was made captain and received a gold medal from Congress. His last command was with the Mediterranean squadron. He died in November 1825, at the age of 42 years.

Some of the elements that fitted Macdonough for his work were the following:

He was fond of adventure and fighting; as a lad he liked practical jokes. As we have seen, he was specially commended for work done on the nocturnal exploit of recapturing and burning the *Philadelphia*. When, after the War of 1812, he was assigned only to land service, he protested that he wished to employ himself "in the arts of my profession." All of the Macdonough boys were reputed to be "full of life." Thomas's brother James was also a midshipman. His father's brother Micah saw service under General St. Clair. His father was wounded while gallantly fighting in the Revolutionary War. His mother's father was a captain in the colonial militia.

He had great foresight and tactical skill. Says Roosevelt concerning the Lake Champlain battle: "He had a decidedly superior force to contend against. He forced the British to engage at a disadvantage by his excellent choice of position; and he prepared beforehand for every possible contingency. His skill, seamanship, quick eye, readiness of resource, and indomitable pluck are beyond all praise." An "example of foresight and accurate reasoning in preparation for the battle, as well as of undaunted perseverance, gallantry, and skill in conducting it to a successful issue," says another critic.

He had tireless energy and patience which enabled him to prepare himself for the fight that was coming and to collect the necessary men and materials despite discouraging conditions. He had no sympathy with idlers. He was punctilious in the discharge of every duty; he knew he could point his best gun better than any other man and reserved that function for himself. This energy and patience were in his father also, who was trained in medicine, but when occasion arose fought well, later served for many years on the privy council and as justice of the court of common pleas, and showed a naturally sound judgment. His father's father, too, was energetic and possessed of business ability of a high order.

Macdonough was a man of fine character. He received the sword of his naval opponent on Lake Champlain without boasting, pointing out certain defects in the work of the smaller vessels of his opponent. His autobiography is modest and unassuming. His charity was broad and catholic and of his own he gave generously, just as his father's father, "a man of fine character and of strong convictions," did to his children during his lifetime.

## FAMILY HISTORY OF THOMAS MACDONOUGH.

I 1 (F F F), Thomas Macdonough, of Ireland. I 2 (F F M), Jane Coyle. I 3 (F M F), Peter Laroux, of Huguenot extraction. I 5 (M F F), John Vance.

*Fraternity of FF:* II 1, John Macdonough, settled in Newton, Long Island. II 2, Augustin Macdonough, went to the West Indies. II 3 (F F), James Macdonough (died 1792), who settled in New Castle county, Delaware, was a physician and an able business man. II 4 (F M), Lydia Laroux (1729-1764). II 5 (M F), Samuel Vance, who settled in Delaware about 1707, was the owner of a grist-mill and a captain in the Delaware colonial militia.

*Fraternity of F:* III 1, James Macdonough, died early in the service of the country in the Revolutionary war. III 4, Micah Macdonough, was an officer under General St. Clair in an expedition against the Indians in 1791. III 5 (F), Thomas Macdonough (1747-1795), in March 1776 was commissioned a major of the Delaware battalion and distinguished himself in active service. In February 1777 he was elected a member of the privy council and served for several years, being elected speaker of the council in 1784 and again in 1787. Later he was made second justice of the court of common pleas and orphans' court of New Castle county. III 6 (M), Mary Vance (1751-1792). III 7 (consort's F), Nicolas Shaler, of New York City.

*Fraternity of Propositus:* IV 1, Lydia, Hannah, Mary, Hester, and Jane Macdonough. IV 2, Samuel, John, and Joseph Macdonough. IV 3, James Macdonough, a midshipman in the navy, who took part in the action between the *Constellation* and the *Insurgente* in 1799. IV 4 (*Propositus*), THOMAS MACDONOUGH. IV 5 (consort), Lucy Ann Shaler.

*Children of Propositus:* V 2, James Edward Fisher Macdonough (1816-1849). V 3, Charles Shaler MacDonough (1818-1871). V 4, William Joseph Macdonough. V 5, Augustus Rodney MacDonough (1820-1907). V 6, Frances Brenton McVickar. V 7, Thomas MacDonough (1822-1894). V 8, Charlotte Rosella Macdonough (1825-1900). V 9, Henry G. Hubbard.

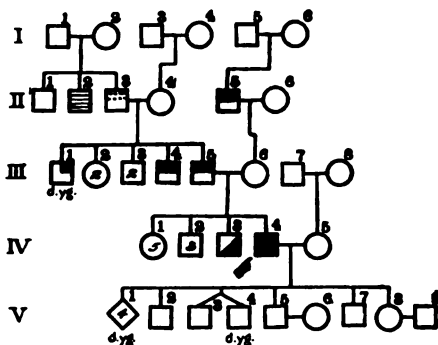

## BIBLIOGRAPHY.

- MACDONOUGH, R. 1895. A Paper on Commodore Thomas Macdonough, United States Navy. (In: Historical and Biographical Papers of the Historical Society of Delaware. Vol. II. 22 pp.)
- MACDONOUGH, R. 1909. Life of Commodore Thomas Macdonough. Boston: The Fort Hill Press, S. Usher. 12 + 313 pp.
- VANDERGRIFT, L. 1895. Memoir of Commodore Thomas Macdonough. (In: Historical and Biographical Papers of the Historical Society of Delaware. Vol. II, pp. 3-14.)

## 37. JOHN NEWLAND MAFFITT.

JOHN NEWLAND MAFFITT was born at sea, February 22, 1819. He was brought up chiefly in North Carolina at the home of his uncle, Dr. William Maffitt. He returned to his father in White Plains, New York, at the age of 9 years, traveling alone, "with a ticket pinned to his jacket." He went to school for a time and at the age of 13 he was commissioned midshipman in the United States navy. In 1835 he was ordered to the *Constitution* and went to the Mediterranean. Appointed acting lieutenant; in 1842 he was detached and ordered to the Coast Survey for a while under Hassler, and in 1843 under Blake. Thus he continued with Gulf Stream and harbor surveys and the like for 13 years, when the naval board voted to furlough him, but having protested that he was only following orders he was restored and placed in command of the United States brig *Dolphin* (1857). In 1859 he was ordered to the command of the United States steamer *Crusader* and sent to capture slavers and pirates. In June 1861 he resigned from the navy and joined the staff of General Robert E. Lee a little later in the year. In January 1862 he took command of the blockade-runner *Cecile* and later secured the *Florida*, which repeatedly ran the blockade of the southern ports, carrying cotton to Nassau and returning with British gunpowder. After the war Maffitt became a farmer near Wilmington, North Carolina, and devoted his evenings to literary pursuits and to reading. He died May 15, 1886.

Maffitt's primary characteristic was a love of adventure and absence of fear. As a small boy he was a leader in all boys' sports and used to run about the woods "like a Mohawk Indian"; at the age of 9 years he willingly traveled alone from North Carolina to White Plains, New York, and this in the days of stage-coaches. His adventurousness and courage are illustrated by his own vivid description of running a blockade, in *The United Service Magazine*, June and July, 1882.

Coming down the Cape Fear River in the swift steamer *Cecile*, to run out to Nassau, he reaches the mouth of the river. "Night glasses scan the bleared horizon for a time in vain; suddenly an officer with bated breath announces several steamers. Eagerly pointing, he reports two at anchor and others slowly cruising. Instantly out of the gloom and spondrift emerges the sober phantom form of the blockading fleet. The moment of trial is at hand; firmness and decision are essential for the emergency. Dashing between two at anchor, we pass so near as to excite astonishment at our non-discovery; but this resulted from the color of our hull, which, under certain stages of the atmosphere, blended so perfectly with the haze as to render the steamer nearly invisible. [The pilot declared they would get through undisturbed.]

"Ere a response could be uttered, a broad-spread flash of intense light blazed from the flag's drummond, for in passing to windward the noise of our paddles betrayed the proximity of a blockade runner. 'Full speed' I shouted to the engineer. Instantly the increased revolutions responded to the order. Then came the roar of heavy guns, the howl of shot and the scream of bursting shells. Around, above and through the severed rigging the iron demons howled, as if pandemonium had discharged its infernal spirits into the air.

"Under the influence of a terrible shock the steamer quivers with aspen vibrations. An explosion follows; she is struck!

"'What is the damage?' I asked.

"'A shell, sir, has knocked overboard several bales of cotton and wounded two of the crew,' was the response of the boatswain.

"By the sheen of the drummond lights the sea is so clearly illuminated as to exhibit the perils of our position, and show the grouping around us of the fleet, as their batteries belched forth a hailstorm of missiles, threatening instant annihilation. . . . As perils multiplied, our Mazeppa speed increased and gradually withdrew us from the circle of danger. At last we distance the party."

Maffitt's daughter, Florence (1842-1883), showed a similar absence of fear. On one occasion, during the running of blockades, she was sent to the States on board the steamer *Nassau*, which at that time was captured by an enemy ship. As told by the enemy:

"She sat on the open deck of the *Nassau* during our firing at her to make her bring to, until the captain warned her of her danger and advised her to go to her cabin. She would watch our guns, and as she saw the flame and smoke jut out would manifest just enough excitement to give the appearance of being well entertained. And she continued to enjoy the amusement through the window of her cabin when she went below. It must be borne in mind that the *Nassau* had tons of powder on board, to realize the awful danger of her situation. A single shell exploding in that cargo would have blown her into a thousand atoms. Her family were told by some who were on board the *Nassau* at the time that Florence urged the captain not to surrender, and when he reminded her of the danger from the cargo of powder and his duty to her father, she exclaimed, with tears in her eyes, that her father would prefer her being blown up than that the steamer should be captured."

Maffitt's son, Eugene A., was a midshipman on the Confederate States steamer *Alabama* under Semmes, and was in her when she was sunk by the *Kearsarge*. He and Semmes plunged into the water as the *Alabama* sunk, were picked up by the British *Deerhound*, and taken to England. On returning to the United States in 1865 he for a time suffered military imprisonment.

Maffitt was highly intelligent, as evinced by his employment on the coast survey. In blockade-running he was full of resources, devices, and deceptions to escape capture. He came of intellectual stock, especially on the paternal side. His father, Rev. John Newland Maffitt (born at Dublin in 1794; died at Mobile, Alabama, in 1850), was a graduate of Trinity College, Dublin, of wealthy parents, and a "born preacher"; he traveled in Ireland as a missionary, and occupied the highest place in popular esteem. Coming to New England, he was an itinerant Methodist preacher there (1822-1830); he then went to Nashville, Tennessee, and issued there the first number of the *Western Methodist*, now the *Christian Advocate*. In 1841 he was elected chaplain to the lower house of Congress.

His father's sister Emily had a mind that sparkled with wit and intelligence; she married into the nobility of England. Her brother William was a physician, who also came to the United States.

Of Maffitt's sibs, Eliza was celebrated for her intellectuality as well as for her beauty; living in Texas, she was called the "Belle of the Brazos." Another sister, Matilda, married a Texas judge and is reputed to have written some of her husband's speeches. A third sister, Henrietta, married General Mirabeau Lamar, the second president of Texas.

Maffitt expressed himself well in writing. He wrote "Nautilus, or Cruising under Canvas" (autobiographical); also articles on "Blockade-running," an extract from one of which is given above. Admiral D. D. Porter remarks on his genial humor as a messmate.



124 HEREDITY AND DEVELOPMENT OF NAVAL OFFICERS.

Maffitt was a great favorite in the United States navy before his resignation, and later with his associates in blockade-running and raiding. He was good-looking and was graceful in manners. Grace and beauty characterized his sisters and his father and father's sister.

FAMILY HISTORY OF JOHN N. MAFFITT.

*Fraternity of P:* I 1, Dr. William Maffitt, who came to Fayetteville, North Carolina. I 2, Emily Maffitt, had a "mind that sparkled with wit and intelligence"; she married into the nobility of England. I 3 (F), John Newland Maffitt (1794-1850), was a graduate of Trinity College, Dublin, and a "born preacher"; coming to America, he was famous as an itinerant Methodist preacher and editor. In 1841 he was elected chaplain to the lower house of Congress. I 4 (M), Ann Carnic.

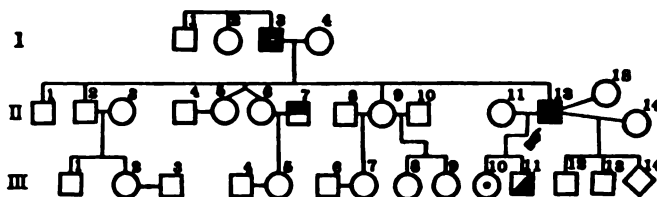

*Fraternity of Propositus:* II 1, William H. Maffitt. II 2, Frederick Maffitt. II 3, Caroline McKeen. II 4, Judge R. D. Johnson. II 5, Matilda Caroline Maffitt. II 6, Henrietta Maffitt. II 7, General Mirabeau Lamar. II 8, Thomas Budd. II 9, Elisa Maffitt, celebrated for her intellectuality as well as her beauty. II 10, Dr. Alexander, of Texas. II 11 (first consort), Mary Florence Murrell, of Alabama. II 12 (*Propositus*), JOHN NEWLAND MAFFITT. II 13 (third consort), Emma Martin, author of "Life and Services of John Newland Maffitt." II 14 (second consort), Mrs. Caroline Laurens Read.

*Children of sibs:* III 1, Walter C. Maffitt. III 2, Matilda Maffitt. III 3, Benjamin Crew. III 4, Samuel Calder. III 5, Loretta Lamar. III 6, Captain Tucker, of Virginia. III 7, Caroline Budd. *Children of Propositus:* III 10, Florence Laurens Maffitt (1842-1883), was devoid of fear. III 11, Eugene A. Maffitt (see text). III 12, John Laurens Maffitt. III 13, Colden Rhind Maffitt.

BIBLIOGRAPHY.

MAFFITT, E. 1906. The Life and Services of John Newland Maffitt. New York: Neale Publishing Co.

## 38. ALFRED THAYER MAHAN.

ALFRED THAYER MAHAN was born at West Point, New York, September 27, 1840. He went to boarding-school, then to Columbia College, New York City, in 1854, and to the Naval Academy in September 1856 (at 15 years of age), whence he was graduated in 1859, and went on a cruise in the *Congress* to the South Atlantic. Commissioned lieutenant in 1861, he saw service in the blockade of the Southern and Gulf States. For the next twenty years he was in active service at sea. While in the Asiatic squadron he saw much of China and Japan. He was appointed president of the newly established Naval War College at Newport, Rhode Island, and served in that capacity from 1886 to 1889 and in 1892-1893. In 1890 his "The influence of sea power upon history, 1660-1783," was published. It has been used as a text-book in all naval colleges of the world. While in command of the *Chicago* in European waters, he was given the honorary degrees of D. C. L. by Oxford and LL. D. by Cambridge in recognition of the value of this work; similar degrees were given him by universities of the United States. He was a member of the naval board during the war with Spain and was appointed by President McKinley a delegate to the Hague Peace Conference. He wrote numerous works on naval matters; a history of his experience in the blockade, "Influence of Sea Power on the French Revolution and Empire," "Life of Farragut," "Life of Nelson" (the greatest of Nelson biographies), "The Interest of America in Sea Power," "Lessons of the War with Spain," "Sea Power in its Relation to the War of 1812," and others, including an autobiographical work "From Sail to Steam," 1907. He died December 1, 1914.

Mahan had the hypokinetic temperament which is so common among the Irish. This appears clearly in the following self-revelation:

"While I have no difficulty in entering into civil conversation with a stranger who addresses me, I rarely begin, having, upon the whole, a preference for an introduction. This is not perverseness; but lack of facility. I have, too, an abhorrence of public speaking, and a desire to slip unobserved into a back seat wherever I am, which amounts to a mania; but I am bound to admit I get both these dispositions from my father, whose Irish was undiluted by foreign admixture."

This hypokinesia forms the background of his thorough work. He found pleasure in study and writing; he did not feel pressure to rush his work, and took time to do it well. His philosophic insight permeates it all. As a writer on naval history he has never been equaled. He understands the essential features of the naval battle he has to describe and he knows how to set them forth. He ranks among the first of the world's biographers. More, perhaps, than any other, he has pointed out how inherited traits of personality have determined performance. Since his biographies are rich in incidents showing the reaction of the propositus to particular situations, they are of the greatest importance for a psychological analysis of the personality. Of his own reactions as an author he writes: "The favorable criticism upon the first sea-power book not only surprised me, but had increased my ambition and my self-confidence." "I now often recall with envy the happiness of those days, when the work was its own reward, and quite sufficient, too; almost as good as a baby." "None but a blockhead would write for money, unless he had to." (Mahan, 1907, p. 311.)

Mahan belongs to a philosophical, scholarly race. His father, Dennis Hart Mahan, born April 1808, was professor of engineering, civil as well as military,

at West Point, for over 40 years. He was of pure Irish blood. He lived for a while in Norfolk, Virginia, was graduated at West Point, and earned a distinguished reputation there. He was sent to France for higher military education. He had no strong bias toward arms, but was very fond of drawing and sought the Military Academy as a means to this end. The following incident illustrates his thoughtfulness: Once he was on a board where an objectionable project was offered by an influential officer. A young member of the board asked his advice about opposing it, hesitating on account of the odium that such opposition would bring to him. Mahan advised the young man against such action and then threw the force of his great influence against the proposition and defeated it.

#### FAMILY HISTORY OF ALFRED T. MAHAN.

I 1 (F F), John Mahan, was born in Ireland and came to New York whence he removed to Virginia. I 2, Mary Cleary, born in Ireland. I 3 (M F), John Okill, of English stock. I 4 (M), Mary Jay, of Huguenot descent, a vivacious woman.

II 1 (F), Dennis Hart Mahan (1802-1871), led his class upon being graduated from the United States Military Academy. He was promoted to the corps of engineers, but remained at the academy as instructor. In 1832 he was appointed professor of civil and military engineering at the academy and, in 1838, dean of the faculty. He published many civil and military text-books. II 2 (M), Mary Helena Okill.

*Fraternity of Propositus:* III 1, Frederick Augustus Mahan (born 1847), was graduated from the United States Military Academy at West Point with the actual rank of second lieutenant of engineers. He served in various capacities as engineer, rising to the rank of major in 1894; in 1900 he retired. He aided in editing the last edition of his father's "Civil Engineering." III 2, Dennis Hart Mahan (born 1849), was graduated from the United States Naval Academy in 1869. He served in the Philippine campaign, 1899-1900, on the U. S. S. *Brooklyn*; he was at Kingston, Jamaica, during the earthquake rescue, commanding U. S. S. *Indiana*. III 4 (*Propositus*), ALFRED THAYER MAHAN. III 5 (consort), Ellen Lyle Evans.

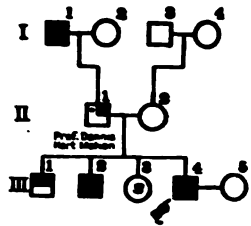

#### BIBLIOGRAPHY.

- ABBOT, H. 1788. *Memoir of Dennis Hart Mahan.* (In: *Biographical Memoirs of Nation. Acad. of Sciences*, 1886. Vol. II, pp. 29-37.)
- MAHAN, A. T. 1907. *From Sail to Steam. Recollections of a Naval Life.* New York: Harper & Bros. xvii + 326 pp.

## 39. JOHN MARKHAM.

JOHN MARKHAM was born at Dean's Yard, June 13, 1761. He was sent to Westminster School at the age of 8 years, was appointed a midshipman at 14 (1775), and sailed for Newfoundland. His ship chased privateers, and at 15 he was made prize-master of a sloop-of-war. In 1779 he took a gallant part in the capture of Charleston, South Carolina, was promoted to a lieutenancy and put in charge of the prize frigate *Confederacy*, and at 20 was given command of a British naval vessel. During this time he seems to have made no important error of judgment, but in May 1782 he mistook a ship sailing under a flag of truce for an enemy and was court-martialed, but later he was restored to his rank. In 1783 Markham commanded a naval vessel in the Mediterranean; later he traveled with a friend through Europe and to America. After the French war broke out he obtained command of a ship (1793) and cruised in the French West Indies. In 1797 he took part in the blockade of Brest, but in 1801 resigned his command. He was then elected a lord of the admiralty and entered Parliament; in 1804 he was made rear admiral; in 1806 first sea lord. His health began to decline and he died at Naples in 1827.

John Markham was not prudent or cautious and was a fearless though not a great fighter. He was honorable, warm-hearted, generous, and never forgot a friend, and his affection for his relatives was deep and strong. He had great application.

By a consort of good family (whose mother's mother's father was secretary of war) he had 4 sons, of whom one, Frederick (1818-1855), became a soldier and saw service in Canada, India, and the Crimea, was extremely fond of hunting big game, and wrote two books on hunting and travel. He never married. A second son, like his father's brothers, father's father, and mother's brother, was a clergyman.

John Markham's father (William Markham) was a clergyman, an Archbishop of York. Like his son he had great application, "an attention that nothing could disturb," also he was affectionate toward his children. He was especially interested in geography. "Dr. Markham often seemed to show a partiality for the profession of a soldier. He, no doubt, possessed in an eminent degree those qualities which would have led to distinction in military life. His judgment was cool, his courage undaunted, his decision quick, his mind energetic, active and enterprising, his constitution capable of enduring fatigue and patience not to be subdued." He was interested in military tactics. Of his sons, besides John, one, David, was remarkably bright and clever and an excellent Latin scholar. He entered the army by inclination, was sent to India, was wounded, returned home, and became major of infantry in 1793, and later, while commanding at Jamaica, lieutenant colonel. He was killed while leading his men at San Domingo in 1795. An intellectual and resolute man; at the same time gentle and warm-hearted.

Two other brothers became clergymen. One, William, after a few years in the civil service in India, settled down in Yorkshire as a country gentleman and indulged his taste for literature, especially the classics. He early became crippled by gout. From William and his wife Elizabeth Bowles are descended David, a clergyman, canon of Windsor, and the father of Sir Clements Markham, the explorer and author; and John, a captain in the Royal Navy and father of Admiral Sir Albert Hastings Markham, the explorer and author. Brother Osborn was a barrister. The fraternity showed a high degree of talent, with diverse tastes and constitutions.

## FAMILY HISTORY OF SIR JOHN MARKHAM.

I 1 (F F F), Daniel Markham, a colonel in the army, who settled in Ireland. I 2 (F F M), Elizabeth Fennel, a granddaughter in the maternal line of Oliver Cromwell. I 3 (consort's M F F), Baron Talbot, lord chancellor. I 4 (consort's M F M), Cecil Matthews, a Welsh heiress. I 5 (consort's M M F), Adam de Cardonnell, secretary of war.

II 1 (F F), William Markham (1686-1771), a major in the army after many years of service. II 2 (F M), Elizabeth Markham, a fourth cousin once removed. II 3 (M F), John Goddard (1690-1766), settled in Rotterdam as a merchant. II 4 (M M), Elizabeth Smith. II 5 (consort's M F), William Earl Talbot. II 6 (consort's M M), Mary de Cardonnell.

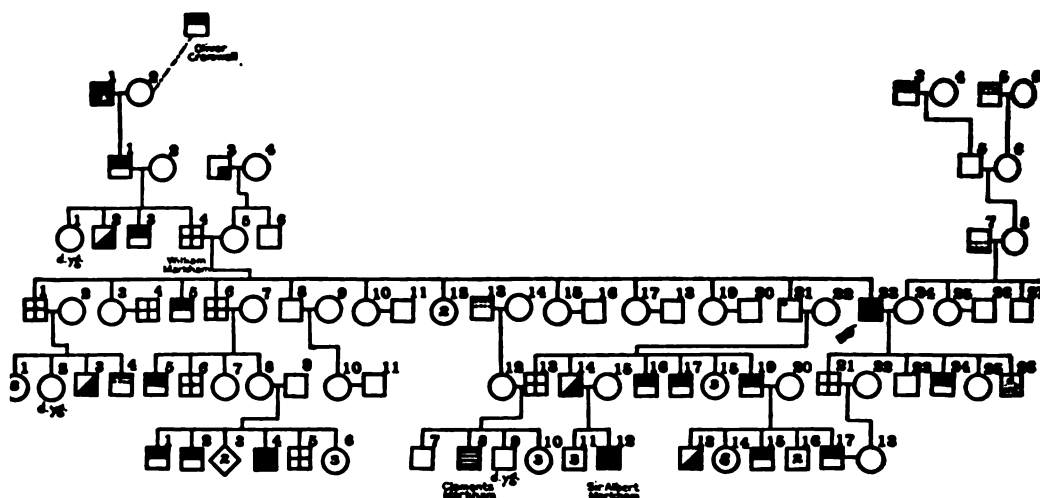

*Fraternity of F:* III 1, Elizabeth Markham. III 2, George Markham, entered the navy at an early age, but left in disgust after many years because he did not get the desired promotion. III 3, Enoch Markham, was a volunteer for American service; later he became major commandant of the Royal Musketeers and then a colonel in the army. III 4 (F), William Markham (1719-1807), a scholar, who became head of Winchester School and Archbishop of York. III 5 (M), Sarah Goddard (1738-1814). III 6, John Goddard. III 7 (consort's F), Hon. George Rice, M. P. III 8 (consort's M), Lady Cecil Talbot.

*Fraternity of Propositus:* IV 1, George Markham (1763-1822), dean of York. IV 2, Elizabeth Sutton. IV 3, Alicia Markham, born 1771. IV 4, Rev. H. F. Mills. IV 5, David Markham (1766-1795), was killed at San Domingo while gallantly leading his men. IV 6, Robert Markham (1768-1837), became canon residentiary of York in 1802. IV 7, Frances, daughter of Sir Gervase Clifton. IV 8, Osborne Markham (born 1769), a barrister-at-law. IV 9, Martha Jervis (see Admiral John Jervis). IV 10, Henrietta Markham, born 1764. IV 11, Evan Law. IV 13, Sir W. Milner, high sheriff, a first cousin on the maternal side of Charles Sturt, the renowned Australian explorer. IV 14, Selina Clements. IV 15, Elizabeth Markham, born 1765. IV 16, W. Barnett. IV 17, Cecilia Markham (born 1783). IV 18, Rev. R. P. Goodenough. IV 19, Frederica Markham, born 1774. IV 20, William, Earl of Mansfield. IV 21, William Markham (1760-1815), a county gentleman with a taste for literature. IV 22, Elizabeth Bowles. IV 23 (*Propositus*), SIR JOHN MARKHAM. IV 24 (consort), Hon. Maria Rice, born 1773. *Fraternity of consort:* IV 25, Henrietta Rice, born 1758. IV 26, Magens-Darrien Magens, a banker. IV 27, George Rice, Lord Dynevor (1765-1852). IV 28, Edward Rice (1776-1862), Dean of Gloucester.

V 3, George Markham (1796-1834), a lieutenant in the navy. V 4, Edward Markham (1801-1865), in the East India civil service. V 5, Robert Markham, a captain in the army, who was killed in a duel in 1832. V 6, Henry Markham (died 1844), canon of York. V 8, Georgina Markham. V 9, George, tenth Earl of Haddington. V 10, Martha Markham. V 11, Rev. William H. Pearson. V 12, Catherine Milner. V 13, David Markham (born 1800), canon of Windsor. V 14, John Markham (born 1797), a captain of the Royal Navy. IV 15, Marianne

Wood. V 16, Warren Markham (1801-1836), a captain in the army. V 17, Charles Markham (1803-1843), a lieutenant colonel in the army. V 19, Colonel William Markham (1796-1852). V 20, Lucy Holbech. *Children of Propositus*: V 21, William Rice Markham (1803-1877), vicar of Moreland. V 22, Jane Clayton. V 23, John Markham (1801-1837), educated at Westminster. V 24, Frederick Markham (1818-1855), a major general, sportsman, and traveler. V 25, Maria Frances Markham (1806-1836).

VI 1, George Baillie Hamilton, eleventh Earl of Haddington, high sheriff, and an army captain. VI 2, Major Robert Baillie Hamilton (1828-1891). VI 4, Henry Baillie-Hamilton (1832-1895), a commander, Royal Navy. VI 5, Arthur Baillie Hamilton (born 1838), vicar of Badley. VI 7, David Markham (1828-1850), died at sea. VI 8, Clements Markham (1830-1916), "as a boy always evinced a decided penchant for the sea." He became renowned as a geographer, explorer, and author of books of travel. VI 12, Sir Albert Hastings Markham, (born 1841), entered the Royal Navy in 1856 and rose to the rank of rear admiral. He is well known as an explorer and writer. VI 13, Alfred Markham, of the Royal Navy. VI 15, Sir Edwin Markham (born 1833), a colonel commandant, Royal Artillery, served in Crimea and India. VI 16, William Markham, born 1830. VI 17, Captain Francis Markham, born 1837. *Children of children of Propositus*: VI 18, Maria Markham, born 1842.

## BIBLIOGRAPHY.

MARKHAM, SIR C. 1883. *A Naval Career of the Old War. Being a Narrative of the Life of Admiral John Markham.* London: S. Low, Marston, Scarle & Rivington. viii + 269 pp.

MARKHAM, D. 1854. *A History of the Markham Family.* London: J. B. Nicols & Sons. xi + 96 pp.

## 40. FREDERICK MARRYAT.

FREDERICK MARRYAT (1792-1848) was born at Westminster, July 10, 1792. He was precocious, learned and forgot easily, and was frequently flogged for inattention. He often ran away from school — once to avoid wearing his brother's cast-off garments — and he always ran toward the sea. At last, at 14 years of age, his father arranged for him to enter the navy in 1806, where he first saw service on the *Impérieuse*, under Lord Cochrane, in the Mediterranean. During the next two and a half years Marryat was in fifty engagements. His captain mentioned him for his bravery. Between 1809 and 1815 he served in North American waters and in the West Indies under various commanders. In 1812 he was made lieutenant and in 1815 commander; he directly afterward married. In 1824 he was at Rangoon, in command of the naval forces there. In 1825 he commanded an expedition up the Bassein river. Returning to England, he was awarded the order of Companion of the Bath and, though often invited to the court of the King, was not in great favor because of his publication against impressment of seamen.

Now began a new life for Marryat, one of great literary productiveness, particularly in the field of novels based on sea-life. He purchased 1,000 acres in Norfolk, but as he could not endure its monotony he went back to London for fifteen years. There he edited a magazine in addition to writing books. In 1837 he went to America and traveled extensively. When the French under Papi-neau revolted in Canada, 1837-1838, he hastened to offer his services. He finally returned to his estate and tried farming again in 1843; but his experiments in this avocation were costly and consumed the large income derived from his books; evidently he had the desire to see things doing when he was on land also. He died in 1848, much depressed by the death of his son Frederick, whose ship sank in 1847.

Marryat loved adventure and was without fear. As a young man he played pranks, and in this respect his son Frederick resembled him. It is said that he

rescued 27 men who had fallen overboard; he early received the medal of the Humane Society for this. His son Frederick went overboard to rescue men in the same way. On one occasion when, off New York harbor, the ship was on her beams end, Maryatt alone had the courage to cut away her main yards. He was restless. Probably there was a nomadic tendency on the mother's side, as her father was a Hessian who had emigrated to Boston, England.

Marryat had the *impulse to write* and the ability to write well. Novels, books of travel, poems even, flowed from his pen. Several of his brothers and sisters were authors, partly of travels. His father wrote political pamphlets. The father's father was a physician, author of "Therapeutics, or the art of healing," and "The Philosophy of Masons"; also verse. Moreover, a cousin, Sir Edward Belcher, wrote two books of travel and a book on surveying. Marryat's son Frank had begun to write books of travel before his untimely death.

Marryat was a *visualist* and very skillful in sketching and caricaturing. During the Burmese war he made a series of sketches representing scenery, people, and engagements of the war. His son Frank, who died young of yellow fever, had his father's ability to draw. Marryat's eldest brother collected china and wrote a book on the subject; a sister wrote a "History of Lace." Doubtless this family appeal of the beauty of form was one of the things that made ships fascinating. He was also something of an inventor. He worked out a signal code for merchant vessels and invented a cipher for secret correspondence. He was very resourceful in bridge-building while at Rangoon.

#### FAMILY HISTORY OF FREDERICK MARRYAT.

I 1 (F F), Thomas Marryat, a physician and an author. I 3 (M F), Frederick von Geyer, a Hessian settler in Boston; a loyalist.

II 1 (F), Joseph Marryat, member of Parliament; author of political pamphlets. II 2 (M), Charlotte von Geyer. II 3 (consort's F), Sir Stephen Shairp, counsel general at the court of Russia.

*Fraternity of the Propositus:* III 1, Joseph Marryat, a collector of china; author of "Pottery and Porcelain." III 2, Horace Marryat, author of "One Year in Sweden." III 3, — Marryat, wrote "Nature and Art" and "History of Lace." III 4, Bury Pattison. III 7 (*Propositus*), FREDERICK MARRYAT. III 8 (consort), Catherine Shairp, had talent and literary taste.

*Children of the Propositus:* IV 1, Frederick Marryat, a lieutenant in the navy who was lost in the wreck of the *Avenger*, in 1847. IV 2, Frank Marryat, died a midshipman in the navy. IV 3, Emily, Augusta, and four other sisters. IV 4, Florence Marryat, novelist and author of "Life and Letters of Captain Marryat." IV 5, Ross Church.

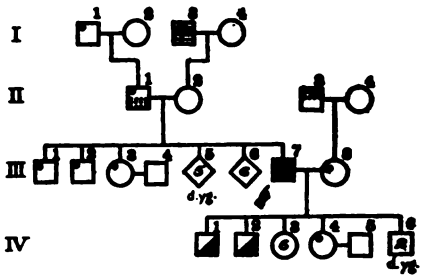

#### BIBLIOGRAPHY.

MARRYAT, F. 1872. *Life and Letters of Captain Marryat*. New York: D. Appleton & Co.

## 41. SIR FRANCIS LEOPOLD McCLINTOCK.

FRANCIS LEOPOLD McCLINTOCK was born at Dundalk, Ireland, July 8, 1819. He entered the Royal Navy at the age of 12 years. At 24 he passed his lieutenant's examination and joined the *Gorgan* steamship, which was driven ashore at Montevideo but salvaged. In 1848 he joined the search for Sir John Franklin, and on his third voyage, in 1854, commanded the *Intrepid*. He developed the system of sled traveling. After the admiralty had abandoned the rescue work, Lady Franklin fitted out the *Fox* in 1857 and put it in command of McClintock, who in 1859 discovered skeletons, other remains, and a manuscript record of the expedition. He also added 800 miles of new coast to our knowledge of the Arctic region. On his return he was knighted. He sounded the North Atlantic for the submarine-telegraph cable route in the sixties. He was elected a fellow of the Royal Society in 1865, was made vice admiral in 1877, and commanded the West Atlantic fleet. He was made K. C. B. in 1891. His book on the "Voyage of the *Fox*" passed through several editions. He died in 1907.

McClintock was a *visualist*; form and color appealed to him. He says himself that it was in part a print of Admiral Berkeley in uniform, which hung in his father's dressing-room, that led him to choose a naval career. Also the appearance of his cousin, Lieutenant Bunbury McClintock, probably dressed as an officer, made an appeal. At any rate, at the age of 12 years he "wanted to go to sea" and went on his cousin's ship, taking with him a bag of marbles that he prized highly (color and form). Returning home on one occasion, he explored the steeple of the Dundalk church, which he had always believed "was built of some beautiful green stone"; but he found it made of wood coated with copper. To him all sorts of organic and even artificial forms were attractive. At 14 years of age he was much interested in the prehistoric antiquities that abounded in his region, and explored the numerous "Danish" forts. Mineralogy, botany, and zoology were favorite sciences, and he read extensively about them, and in the Arctic he collected fossils, minerals, plants, and animals. He was an ardent hunter. This love of form extended also to machinery. At the age of 24 years he had already mastered the structure of steam machinery, and when, in the Arctic in 1859, the engineer who had taken the engines to pieces died, the commander was the only one on board who could get them into working order again. Some of the elements of the foregoing are found in his father, who hung the print of Admiral Berkeley in his own room and was himself a lover of the horse and of sport. His brother became an eminent physician, president of the College of Physicians and Surgeons in Ireland.

McClintock was something of a *nomad*; he longed to see new countries. As a young man he was a great walker. In the first Arctic trip he walked 770 miles in 80 days, exploring Melville Island for traces of the Franklin party.

*Ability in command* is another trait. He understood and managed men. His book reveals abundant evidence of his "consummate leadership." Those who worked with him or served under him felt the most unbounded confidence in his judgment and resolution. This ability appears also in the son of his father's brother John. Lieutenant W. Bunbury McClintock did not drink or swear and exerted a good influence on those under him. He was one of the first, if not the first, to introduce the use of "port" instead of "larboard" into the service. One of McClintock's sons was appointed a commander in the Royal Navy in 1905; another was a major in the Royal Engineers who served in Nigeria and in South Africa.



McClintock was something of a *hypokinetic*. As admiral he was "reserved and somewhat indisposed to talk." He was self-controlled. He was habitually quiet and perfectly calm, seeing everything done himself without noise or fuss. He weighed a question for some time before acting, but when once his mind was made up he acted promptly. He was "full of a kindly quiet humor, which smoothed away difficulties. He seemed to live above the petty annoyances of daily life. His judgment of others was always generous, and scandalous or unkind talk never failed to arouse his indignation." He was economical, even rigid toward himself in money matters, and very generous to others. When he became a lieutenant he began making a regular allowance to his mother. His personal tastes and habits were simple. He was governed by a deep religious feeling. His writings are accurate and free from display.

For the hypokinetic, adventure and a touch of danger bring a grateful stimulus. Such a situation "seemed to inspire him with the lofty touch of exhilaration." His face lit up with animation and his words came with more than usual readiness and cheerfulness of tone. This hypokinesis is common in the Scotch-Irish. A kinsman is Rev. William Alexander, D. D., archbishop of Armagh and primate of all Ireland. McClintock's mother was the daughter of the Venerable Doctor Fleury, D. D., archdeacon of Waterford; so a religious tendency probably came from this side also.

FAMILY HISTORY OF FRANCIS LEOPOLD MCCLINTOCK.

I 1 (F F), John McClintock (born 1742), was a large landed proprietor and a member of Parliament in the Irish House of Commons. I 2 (F M), Patience Foster. I 3 (M F), Doctor Fleury, archdeacon of Waterford; was of Huguenot ancestry. I 4 (M M), — an English lady. I 5 (consort's M F), Viscount Ferrard. I 6 (consort's M M), Viscountess Masureene.

*Fraternity of F:* II 1, Miss Bunbury. II 2, John McClintock. II 3, Lady Elizabeth Trench. II 4 (F), Henry McClintock (died 1843), was in the army; afterwards he was in charge of the custom-house in Dundalk. II 5 (M), Elizabeth Melesina Fleury, a "pretty woman of remarkable ability and energy." II 6 (consort's F), R. F. Dunlop. II 7 (consort's M), Anna Skeffington.

III 1, — McClintock, an officer in the Portsmouth garrison. III 2, W. B. McClintock, who afterwards changed his name to McClintock Bunbury; entered the navy and at the age of 36 years became a commander. Subsequently he inherited a fortune, retired from the navy, and went into Parliament. *Fraternity of Propositus:* III 3, Louis McClintock, died young. III 4, Alfred Henry McClintock (born 1821), became an eminent physician in Dublin and was president of the College of Surgeons of Ireland. III 5, Theodore Ernest McClintock, a lieutenant colonel. III 6, Charles Fortescue McClintock. III 24 (*Propositus*), FRANCIS LEOPOLD MCCLINTOCK. III 25 (consort), Annette Elizabeth Dunlop.

*Children of Propositus:* IV 1, Henry Foster McClintock, was in the secretary's department of the general post office; served as a reserve officer in the South African war for 3 years; received medals for his services. IV 2, John William Leopold McClintock, entered the navy and became a commander in 1905; won a medal for saving a seaman's life. IV 3, Robert Singleton McClintock, served in the British army abroad; in 1904 was made brevet major of the Royal Engineers; in 1908 he joined the staff college. He won 3 medals. IV 5, Bernard Eyre Greenwell.

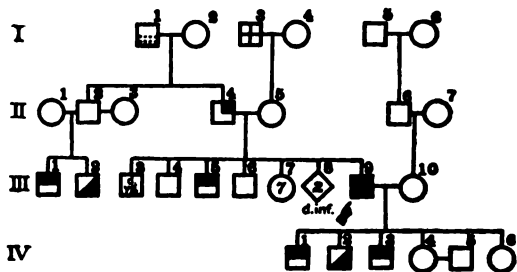

BIBLIOGRAPHY.

MARKHAM, SIR C. 1909. Life of Admiral Sir Leopold McClintock. London: J. Murray. xx + 370 pp.

## 42. FAIRFAX MORIESBY.

FAIRFAX MORIESBY was born at Calcutta, India, in 1787. He was reared as a child at Lichfield, England. It was said of him:

"Far inland as his home was, all his predilections were for the seafaring life, and in the long summer his delight was to lie concealed in the waving grass, watching its billowing with half-shut eyes, until, seeing only the blue sky and undulating green, he could imagine himself on the lonely ocean, far out of sight of land in the centre of circling horizons. . . . The realization of his dream came with the offer from a neighbor and friend, Captain William Parker, of a berth on board, and acceptance was a foregone conclusion. There was never a moment's hesitation."

When a midshipman on the *Amazon* the severity of the captain made young Moriesby desert; he left the ship at Portsmouth and "set out on a hopeless tramp to Coshan," but on the way he met a kindly captain who returned him to his ship and arranged matters for him. As a midshipman he was constantly in charge of prizes and was captured on one of them and taken prisoner to Malaga. Exchanged, he served for a time under Nelson. He formed one of Napoleon's sea-guard at St. Helena. Under his superintendence the first settlement was made at Port Elizabeth, on the east coast of Africa, to stop the slave traffic; he had many adventures. His health failed prematurely. In later years he was intrusted with diplomatic missions. He became rear admiral (1849) and later vice admiral.

Fairfax Moriesby had a compound of high idealism and almost romantic gallantry, subdued by a devotion to the practical side of duty. He was always ready to accept responsibility and was prompt in decision, tactful, and prudent.

A brother of Fairfax was Robert Moriesby, a surveyor and explorer, the first to survey the northern half of the Red Sea. His next great survey was that of the coral islands, and this work was of great assistance to Charles Darwin in preparing his work on the structure and distribution of coral reefs. (Markham, 1909, p. 336.)

John Moriesby (born 1830), son of the preceding, spent his childhood in Allerton, England, where his father rented a farm and was living on half pay. Autobiographically, he says: "The magnet which chiefly drew our restless feet was the mill, with its dripping water-wheel and mighty grinding-stones. "At the age of 12 he was appointed volunteer on H. M. S. *Victor* in the West Indies. After sundry cruises he sailed (1850) on the *Amphitrite* for the Pacific and delighted in the hunting at Falkland Islands and in the vicinity of Valparaiso. At Vancouver he gained leave of the captain to explore the mountains. He also made a successful trip to a distant tribe of Indians to capture the murderer of a white man. After some further years of miscellaneous service he was given (1871) command of the *Basilisk* and explored some 600 miles of the until then unvisited coast of New Guinea, adding to the chart some 140 islands and islets, and surveying many excellent harbors, including Port Moriesby, now the capital of British New Guinea. From 1872 to 1875 he cruised and explored in Melanesia and New Zealand. He published two books on New Guinea and a life of himself and his father.

Comparing father and son, we see that both have a *taste for adventures*. The former is more a diplomat; the latter, an explorer. As an explorer his tastes were almost exactly like his father's brother's. Both father and son readily accepted responsibility. The father's father was a lieutenant colonel in the militia.

## BIBLIOGRAPHY.

- MARKHAM, C. R. 1909. Review of Two Admirals, etc. Geogr. Journal. xxxiv. pp. 336-338.  
 MORIESBY, JOHN. 1909. Two Admirals: Admiral of the Fleet Sir Fairfax Moriesby and his son, John Moriesby. London: J. Murray. xii + 419 pp.

## 43. CHARLES MORRIS.

CHARLES MORRIS was born July 26, 1784, at Woodstock, Connecticut, and spent the first fifteen years of his life there, working on the farm and reading everything he could lay his hands on. Charles entered the navy as a midshipman at the age of 15 years, through the assistance of his father, who was purser in the navy. He first was on ships with his father. He saw his first war service on board the *Constitution*, Commodore Preble, during the war with Tripoli. His father's brother now became secretary to Commodore Preble, so young Morris had the benefit of his company and advice. After the *Philadelphia* had grounded and was captured by the Tripolitan gunboats, Morris was one of a party who undertook to drift into the harbor at night, on a vessel disguised as a merchantman, and who boarded the *Philadelphia*, set fire to her, and escaped. After some further experiences in various vessels he returned to America; but after a time was at sea again as first lieutenant (1809), enforcing the embargo. On the *Constitution*, under Captain Isaac Hull, he was one night at Portsmouth, England. An American sailor who had deserted to a British man-of-war, *Havana*, was not given up on the ground that he claimed to be a British subject. Shortly afterwards, a deserter swam to the *Constitution* and stated (in Irish brogue) that he was an American. When the British sent a boat for him, Morris (in the absence of Captain Hull) refused to surrender him, giving the same reason that the British had given shortly before; the British threatened to use force, but the swift *Constitution* outsailed them. When the War of 1812 broke out the *Constitution* was at Annapolis and was ordered to New York, but in Chesapeake Bay she fell in with a small blockading squadron under Captain Broke. A dead calm ensued, so that no fight or pursuit was possible, but the *Constitution* got away by use of the device of kedging suggested by Morris—rowing the kedge-anchor out for a mile beyond the ship and hauling in at the ship end. Thus the *Constitution* eluded her pursuers and reached Boston. Thence she went to Nova Scotia and captured a number of English vessels and, on August 19, 1812, met the *Guerrière*. Morris had charge of the firing and was with difficulty restrained until the two vessels had come close enough so that every shot of the *Constitution* would tell. The battle was won; Morris was wounded badly, but recovered. In March 1813 he was promoted to be captain. He remodeled the signal-book for the secretary of the navy. In 1814 he was put in charge of the sloop-of-war *Adams*, blockaded in the Potomac, and, on January 18, 1814, ran the blockade during a snowstorm and put to sea. During the next seven months he captured 10 merchantmen carrying in all 161 guns. On the Maine coast he ran upon the rocks, was pursued by a British squadron, got his vessel off at high tide and into the Penobscot river, where he burned the leaking *Adams* and escaped with all of his men. After this episode he was employed in the Boston navy-yard. In 1816 he commanded a squadron in the Gulf of Mexico, where the Spanish were making trouble, and in 1819-1820 was in South American waters during a revolution in Buenos Aires. From 1823 to 1827 he was a navy commissioner. In 1825 he was chosen to convey La Fayette to France in the *Brandywine*, and while in Europe he visited the dockyards in France and England. He was again a navy commissioner through 1832-1841, during which time he sent out the exploring expedition under Wilkes. He was for some time director of the United States Naval Academy at Annapolis, and in the last five years of his life was chief of the bureau of ordnance and hydrography.

Charles Morris was a *fighter of fighting stock*. His father, Charles Morris, born in 1762, enlisted in the Continental Army under General La Fayette at the

age of 16; later he shipped on board a privateer, was made prisoner, and confined in the hulks at New York until the close of the war; after that he commanded a merchant vessel in the South American trade. He and his crew were captured by pirates, his vessel was confiscated, and all were held prisoners for two years, until he escaped to an English war-vessel in the Orinoco river.

Of the brothers of the propositus, Horace (1789-1862) entered the War of 1812, becoming third lieutenant in 1813. He was then in the navy for a short time. The vessel on which he served was boarded by the British, who ordered him aboard their ship. He refused to go and, springing into the rigging, threatened death to anyone who tried to take him. He had an "active temperament" and was very courageous. He loved study and reading and was little inclined to talk. Another brother, George (born 1790), entered the army during the war of 1812 and rose to be a captain of artillery, remaining in the army after the war; his son Robert (1822-1839) was fond of botany, became a midshipman in the United States navy, undertook extensive cruises. Still another brother (1792-1812) was a lieutenant in the army, March 1812, and was killed in the attack on Queens-town in October of that year; he died unmarried. Two sons of the propositus (Charles William and Robert Murray Morris) were soldiers.

*Love of the sea* is also a family trait. The father and the father's brother, Noadiah Morris, were naval men and one of the sons of the propositus (George Upham Morris, 1830-1875) was a sailor.

## FAMILY HISTORY OF CHARLES MORRIS.

I 1 (F F F), Samuel Morris (born at Roxbury, Massachusetts, 1695), served during the French and Indian war. I 3 (F M F), Benjamin Wilkinson (1713-1803), an enterprising keeper of a tavern (see Hopkins, IV 13). I 4 (F M M), Mary Rhodes.

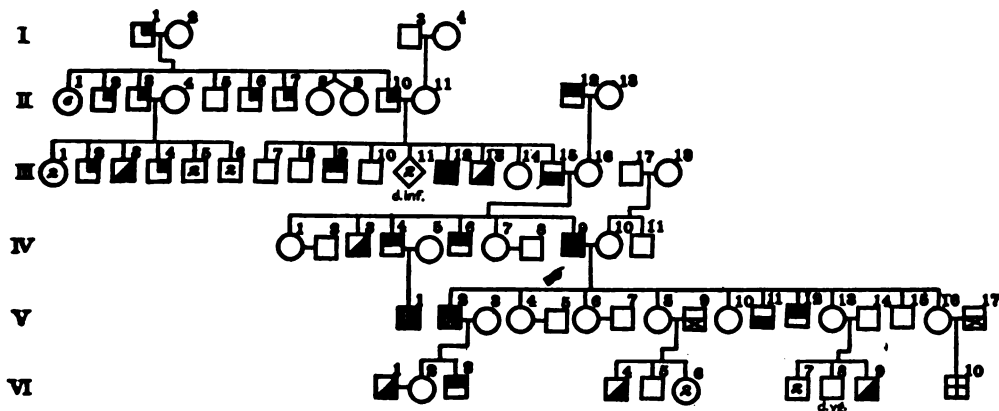

*Fraternity of F F*: II 1, Mehitable (1729-1730), Mehitable (1731-1750), Anne (born 1739), Abigail (born 1742), Susanna (1743-1768), and Lucretia (1749-1750) Morris. II 2, Samuel Morris (1731-1801), served in the Revolutionary war. II 3, Henry Morris (1734-1808), was a corporal in the French and Indian war; in 1758 a sutler at Lake George; in May 1775 he enlisted, becoming corporal and later sergeant. He was a great pedestrian and jumper; at the age of 70 years he could clear a fence at a bound. He removed to New Hampshire in 1790. II 4, Hannah Frissell. II 5, John Morris (born 1735). II 6, William Morris (born 1740), served in the Revolutionary war and later moved to Vermont. II 7, Edward Morris (1745-1821), a farmer who was a lieutenant in the army. II 8, 9, Elizabeth and Hannah Morris, born 1747. II 10 (F F), Lemuel Morris (1737-1813), lived in Thompson, Connecticut, and then removed to Scituate, Rhode Island, but finally settled in Woodstock, Connecticut. He was a farmer who served in the French and Indian war. II 11 (F M), Lydia Wilkinson, born in Scituate, Rhode Island, 1744. II 12 (M F), Captain Jonathan Nichols, of Mansfield, Connecticut. II 13 (M M), Sarah Bassett.

III 1, Lucretia (died at 13 years of age) and Lucretia Morris (born 1763). III 2, Henry Morris, was a prisoner of war on the *Jersey*. III 3, Simeon Morris, a midshipman. III 4, Benjamin Morris, disappeared in the War of 1812. III 5, William and Adolphus. III 6, Samuel (born 1774) and Ebenezer Morris (born 1778). *Fraternity of F*: III 7, George Morris (born 1763), went to England and was probably lost at sea. III 8, Samuel Morris (born 1767), removed to Otsego, New York. III 9, Rufus Morris (born Scituate, Rhode Island, 1772), was a farmer who moved to Florida, New York, where he held the office of supervisor. In the War of 1812 he was an officer in the State troops and was stationed at Sacketts Harbor. III 10, Pardon Morris (1776-1855), went to New York State; a farmer. III 11, Lydia (1779-1793) and Robert Morris (1781-1782). III 12, Lemuel Morris (born 1783), in 1808 was in South America and in 1809-1810 on the frigate *President* as secretary and chaplain to Captain Bainbridge. Then he engaged in commercial business in Rio de Janeiro. In 1813 he was on the *Adams*, commanded by Captain Charles Morris. In August, as a captain of the "Sea Fencibles" he was stationed at Sandy Hook. Later he was again at sea, then in France and South America. III 13, Noadiah Morris (1774-1808), entered the navy as secretary to Commodore Talbot and served in various capacities. In 1803 he went to Tripoli as secretary to Commodore Preble. In July 1803 he became a chaplain in the navy and in December was appointed purser. In 1805 he was in the Navy Department, but in 1806, engaging in commercial enterprises, he traded to Liverpool and the Mediterranean, and later to South America. III 14, Mary Morris (1786-1865). III 15 (F), Charles Morris (born 1762), at the age of 16 years served in the Continental army, then on board a privateer. After the war he engaged in commercial pursuits, sailing to the West Indies and South America. In 1799 he was a purser in the old navy on board the *Baltimore*. In September of that year he was elected to Congress. III 16 (M), Miriam Nichols (1764-1809). III 17 (consort's F), William Bowen (died 1812, aged 96 years), an eminent physician of Providence, Rhode Island.

*Fraternity of Propositus*: IV 1, Lucy Morris, born 1787. IV 2, David Hopkins of Middlebury, Vermont. IV 3, Horace Morris (1789-1862), served in the army and navy (see text). IV 4, George Morris (born 1790), became a captain of artillery, United States Army. IV 5, Sarah Mumford of New York. IV 6, Robert Morris (1792-1812), at the battle of Queenstown, October 13, 1812, was wounded in the arm, but kept on with his company until he was killed in action. IV 7, Maria Morris, born 1802. IV 8, Benjamin Lear. IV 9 (*Propositus*), CHARLES MORRIS. IV 10 (consort), Harriet Bowen (1791-1878). *Fraternity of Consort*: IV 11, William Corlis Bowen, studied medicine and went abroad, where he became interested in chemical pursuits and finally lost his property and his life in experiments.

V 1, Robert S. Morris (1822-1839), was appointed a midshipman in the United States navy, December 1837. He cruised to Africa, India, Manila, and the Hawaiian Islands, where he died. *Children of Propositus*: V 2, Charles William Morris (1815-1846), was appointed a midshipman of the United States navy in September 1829. During the war with Mexico he engaged in an expedition to Tobasco and, while going to the assistance of a brother officer, was mortally wounded. V 3, Caroline Devons. V 4, Harriet Bowen Morris, born 1817. V 5, Dr. James Ringgold. V 6, Louise Amory Morris (1818-1840). V 7, William Corcoran, a philanthropist. V 8, Elisabeth Morris (born 1821). V 9, Dr. John Fox, of the United States navy. V 10, Helen Maria Morris (1822-1843). V 11, George Upham Morris (1830-1875), followed the sea. V 12, Robert Murray Morris (1824-1880), was graduated from the United States Military Academy in 1842. He received the brevet of first lieutenant for gallant and meritorious conduct in the battle of Contreras, August 1847; brevet of captain at Chepultepec; and brevet lieutenant colonel at Dinwiddie Court House, Virginia, 1865. V 13, Maria Lear Morris, born 1828. V 14, Rev. Thomas Duncan. V 15, William Bowen Morris (1826-1878), a physician. V 16, Julia Howe Morris, born 1832. V 17, Dr. S. Ridout Addison, of the United States navy.

*Children of children of Propositus*: VI 1, Lieutenant Arthur Watson, of the United States Marine Corps. VI 2, Caroline Morris (born 1841). VI 3, Charles Morris (born 1844), upon being graduated from the United States Military Academy, was appointed second lieutenant and in 1867 took part in Hancock's Indian expedition. From 1878 to 1881 he was professor of military science at the Massachusetts Agricultural College; in 1882 he was raised to the rank of captain of the artillery. VI 4, Charles Fox (born 1851), a lieutenant, United States navy. VI 5, William Fox, born 1857. VI 6, Helen (1848-1854) and Elisabeth (1853-1880) Fox. VI 7, Murray (born 1858) and Richard (born 1868) Duncan. VI 8, William Duncan (1859-1876). VI 9, Louis Duncan (born 1861), an ensign, United States navy. V 10, Charles Addison (born 1856), a clergyman.

## BIBLIOGRAPHY.

- MORRIS, C. 1880. *Autobiography of Commodore C. Morris*. Annapolis: A. Williams and Co.  
 MORRIS, J. 1887. *A Genealogical and Historical Register of the Descendants of Edward Morris of Roxbury, Massachusetts, and Woodstock, Connecticut*. Hartford: Case, Lockwood and Brainard Co. xvii + 406 pp.

## 44. HORATIO NELSON.

HORATIO NELSON was born at Burnham Thorpe, county of Norfolk, England, September 29, 1758, the fifth son of a clergyman in limited circumstances. Two stories told of his childhood were significant for his future. One winter day he and his elder brother were going to school upon their ponies. The snow was so deep as to hinder their progress and to lead them to return home, where the elder reported that they could not get on. It is stated that the father replied: "If that be so, I have of course nothing to say; but I wish you to try again, and I leave it to your honor not to turn back, unless necessary." On the second attempt the elder brother was for returning, but Horatio persisted, repeating continually: "Remember it was left to our honor," and the difficult journey was successfully accomplished. The other story is to the effect that the master of the school had a fine pear tree covered with ripe fruit, which the boys wanted but dared not pick. Finally Nelson climbed the tree by night, carried off the pears, gave them all to his school-mates, and refused to eat any of them, saying that he had taken them only because the others were afraid. All through life he was picking the fruit of victory and asking little for himself except the honor.

When Horatio was 12 years of age he suggested to his father the plan of going to sea with his mother's brother, Captain Maurice Suckling, then in command of the *Raisonné*, 64 guns, and this plan was carried out. His uncle having been assigned to a station on the river Medway (Thames estuary) saw to it that Horatio got experience on the sea and sent him on a merchantman to the West Indies. His uncle next assigned him to duty in the cutter and decked long-boat attached to the war-vessel. In charge of these boats he became a good pilot of the estuary, and learned confidence and responsibility. At about 16 he went on a north polar expedition. The story is told of his daring pursuit of a polar bear on the ice; he was saved from probable death only by a gun fired from the ship to terrify the animal. Next he went, at his urgent request and through his uncle's influence, on a small naval vessel to the East Indies. Next he served for six months in the Mediterranean, and then passed his examination as lieutenant at the age of 19 years. The young officer was now attached to the naval frigate *Lowestoft*, Captain William Locker, which went to the Jamaica station. He got himself assigned to a schooner, tender of the *Lowestoft*, and carefully studied all the passages through the keys north of Cuba. As Captain Locker had to return to England because of illness, he got Nelson transferred to the flagship, under Admiral Sir Peter Parker — a move of great advantage to Nelson's future. Nelson's independent career begins with his appointment as post captain to the *Hinchinbrook* frigate in June 1779, in which he cruised about the Gulf of Mexico and Caribbean sea. He convoyed an expedition of 500 men to Nicaragua; but, though his duty was done when the troops were brought to Greytown, he took 47 seamen and marines in boats up the river, captured a small outpost by storm, and urged that Fort San Juan be reduced in the same way; but the military commander preferred the method of siege, though this led to delay and a heavy loss of life from yellow fever, malaria, and dysentery. Nelson himself barely survived the last-named disease; but, returning to England, was recovered by August 1781 sufficiently to enter upon his appointment to the frigate *Albemarle* for convoy duty in the Baltic and after that to Quebec. Thence he went with Lord Hood's fleet to the West Indies and shortly afterwards home to England. He then spent some months in France.

Nelson was next, at the age of 26, appointed to the command of the *Boreas* frigate, in which he sailed for the West Indies. Here his breadth of view and tenacious temperament showed themselves markedly. When his ship entered the French harbor at Martinique and did not receive the proper salute from land, Nelson demanded and received amends; when at Antigua he found a British vessel, whose captain was junior to him, flying a commodore's pennant (signifying superiority in rank and command), he demanded the meaning of this. Informed that the venerable captain who was commissioner of the navy at the dockyard there had so ordered it, Nelson took the ground that no civil appointee could exercise naval command and he refused to obey the captain's orders. Again he insisted that, under the navigation laws, American merchantmen could not trade in the West Indies. In this stand Nelson opposed his own easy-going admiral and the desires of the governors and peoples of the islands; but he was technically correct and was supported by the government. Here, at Nevis, he met and married the widow of Dr. Josiah Nisbit.

After some years of non-employment in the navy, Nelson, now 34 years of age, was given command of the *Agamemnon*. This was in 1793, during the height of the French revolution. Nelson's rise was henceforth to lie parallel to that of Napoleon; and the defeat of the plans of the latter on the sea was due primarily to the genius of the former. Nelson now entered the Mediterranean, which was to be the scene of his activity for the next seven years. He helped in the blockade and occupation of Toulon and cooperated from his squadron with the Austrian army which was disputing Napoleon's progress into Italy along the Riviera. When it seemed to the admiralty wisest to abandon the Mediterranean, Nelson evacuated Bastia, on Corsica, bringing with him all the British property, despite the resistance of the inhabitants; and later he effected the evacuation of Elba. Under Jervis he fought in the battle of St. Vincent. As his ship proceeded in battle-line, according to orders, past the enemy's fleet, he saw clearly that the thing to do was to leave the battle-line to prevent the separated portions of the enemy's fleet from uniting. This he did, singlehanded, without orders, and his ship was terribly punished before he was supported by Collingwood and others; but his action prevented the union of the enemy and insured the greater victory. In this engagement two of the enemy's ships had become entangled in each other's rigging. Nelson ran alongside of one and boarded both of them, receiving the swords of two vanquished Spanish captains at once. Again he had seen the big thing to do and had done it. For his gallantry and intelligence he was knighted. He next attempted to capture the island of Teneriffe, but was defeated and lost his right arm in the effort (July 1797).

The way was now prepared for Nelson's three great campaigns, in which he showed his unrivaled strategy and tactics. The first was his campaign to intercept Napoleon's naval expedition to Egypt. Though Napoleon eluded him, Nelson found the French fleet in Aboukir bay as the day was closing. Without hesitation he descended on the fleet and fought into the darkness; and only two of the French vessels escaped, to yield to his ships some months later.

Ordered west, he sailed for Naples to make repairs. Here he met Lady Hamilton, his infatuation with whom persisted throughout his life and led to the divorce of his wife and the scandal of England. At Naples he wasted much of two years. In 1800 he returned overland to England in the company of Sir William and Lady Hamilton. In the spring of 1801 he was sent, under Admiral

Sir Hyde Parker, to destroy the confederacy against England (of Denmark, Sweden, and Russia) instigated by Napoleon. When the fleet arrived at the bay of Copenhagen the admiral regarded the enemy as impregnable; but Nelson was permitted to attack with 12 ships-of-the-line and, though his losses were heavy, he won what his fleet was sent for — the dissolution of the confederacy. Nelson was promptly given full command over the fleet, relieving Parker.

The third great campaign was that against the French-Spanish naval combination with which Napoleon planned to invade England. After much effort he finally succeeded in engaging the main fleet off Trafalgar, October 21, 1805. He had already carefully instructed his captains as to tactics; but on the day of battle the position of the enemy's fleet was unexpected. Rapidly adjusting his tactics to meet the emergency and signaling "England expects that every man will do his duty," he ordered Collingwood, second in command, to cut the enemy's line in two near the middle while Nelson engaged the enemy's flagship just in front of the middle. With his 27 ships Nelson defeated the 33-ship fleet of the allies and took or destroyed in action 18 of them. But Nelson was killed by a musket-shot from the rigging of the enemy and died on the day of his victory.

In attempting to interpret the life-work of Nelson we do well to consider the words of his greatest biographer, Mahan (1897, 1, p. 2):

"The man's self and the man's work, what he was and what he did, the nature which brought forth such fruits, the thoughts which issued in such acts, hopes, fears, desires, quick intuitions, painful struggles, lofty ambitions, happy opportunities have blended to form that luminous whole, known and seen of all, but not to be understood except by the patient effort to resolve the great result into its several rays, to separate the strands whose twisting has made so strong a cord."

Of this "nature" the most striking characteristic is a *dualism* — on the one hand a prevailing depression and on the other a tendency at times to loose all fetters of his spirit and exhibit as little control of it as a young child. In the latter state ambition rises; fear, even reasonable caution, disappears; action follows close upon ideas, and ideas often crowd one upon the other; the output of energy, of joy, of self-satisfaction is extreme; responsibility is readily assumed. This state is that of feeble inhibition; in an extreme type of this state "hysterical" symptoms are shown.

Nelson was often *depressed*. He repeatedly writes in this strain. Thus, in June 1795: "I am out of spirits, although never in better health." (Mahan, 1, p. 175.) Some time after the battle of the Nile, while at Palermo, he writes: "My only wish is to sink with honour into the grave, and when that shall please God, I shall meet death with a smile. . . . I am ready to quit this world of trouble, and envy none but those of the estate six feet by two." Says Mahan (1, 413): "Mingled as these expressions were with despondent broodings over his health, even if the latter were well founded, they are the voice of a mind which has lost the string of self-content. The sense of duty abides, but dogged, cheerless; respondent rather to the force of habit than to the generous ardor of former days." Again, on Channel service, in 1801, he writes to Lady Hamilton: "My heart is ready to flow out of my eyes. I am not unwell but I am very low [*i.e.* in spirits]. I can only account for it by my absence from all I hold dear in this world" (Mahan, 11, 139). As a young man of 27, at the island of St. Nevis, it was observed of him at a party: "He came up just before dinner, much heated, and was very silent; but he seemed, according to the old adage, to think the more. Having drunk



the toasts, he uniformly passed the bottle, and relapsed into his former taciturnity. It was impossible . . . to make out his real character; there was such a reserve and sternness in his behaviour" (Mahan, I, 66).

In obvious contrast to the depressed state is the *active, self-satisfied, joyful* one which in Nelson often found himself. Of him at the age of 22 years Mahan (I, 28), says: "His instinct . . . was ever inclined to instant and vigorous action." Much later, in 1805, he suggested (correctly) that Spain was contemplating declaring war with England and without instructions ordered a general seizure of Spanish vessels of war and commerce throughout his station. And Mahan (I, p. 259) adds: "What a wonderful instinct it shows in him that, with action ever prompt to the verge of precipitancy, he made so few blunders in deed." This promptness of reaction is a hyperkinetic symptom. In such state the inhibitory mechanism seems to be inactive, and consideration of consequences, the weighing of advantages and disadvantages, is omitted. If the hyperkinetic has a good memory of past experiences and of historical incidents and is a keen and sympathetic observer, his "intuitions" are corrected as they are formed and his action is generally approved. If, on the other hand, the hyperkinetic has poor memory and observation he is called rash, precipitous, and is generally regarded as dangerous. Nelson's "intuitions" were usually correct. It is characteristic of the hyperkinetic that he wants strongly to act in accordance with his ideas; and if prevented he becomes excited. This excitation which follows blocking may be regarded as being biologically "useful," since in excitement the superrenals secrete copiously and their secretions strengthen muscular contractions, and this added power tends to enable the excited person to overcome the obstacle. In Nelson's case the excitement showed itself sometimes in the form of impatience. Having decided to buy a house in the Downs, he found difficulty in doing so. "As usual," says Mahan (II, 149), "in undertakings of every kind, he chafed under delays." "[Even] 'if the Devil stands at the door,' he tells St. Vincent, 'we shall sail to-morrow forenoon.' The admiralty . . . imposed upon him a delay under which he chafed angrily" (Mahan, II, 188). Angry outbursts are, indeed, the next strongest symptoms of excitement. When the admiralty refused to let him leave his Channel fleet and come to London, he breaks out angrily: "'They are beasts for their pains,' he says: 'it was only depriving me of one day's comfort and happiness, for which they have my hearty prayers.' His spleen breaks out in oddly comical ways: 'I have a letter from Troubridge [of the admiralty; a former captain under Nelson, much lauded by him] recommending me to wear flannel shirts. Does he care for me? No, but never mind.' 'Troubridge writes me, that as the weather is set in fine again, he hopes I shall get walks on shore. He is, I suppose, laughing at me; but never mind.'" And these petulant remarks Mahan (II, p. 142) properly ascribes to "the excitement of baffled longings." When he lost the French fleet at the West Indies because of incorrect information, he wrote "wrathfully": "There would have been no occasion for opinions had not General Brereton sent his damned intelligence from St. Lucia." After the French fleet had escaped him out of Toulon he is described "as almost raving with anger and vexation" (Mahan, II, 289).

When, on the other hand, the impulse was followed by action, the accompanying emotions were in every way agreeable. The excitement of doing weakened the inhibitions, and further action followed easily and pleasurably. It is stated by Southey that in battle Nelson became animated and even jovial. Says

Mahan (II, 52): "The exultant delight unquestionably felt by Nelson in battle did not indicate insensibility to danger, or to its customary effects upon men, but resulted from the pleasurable predominance of other emotions which accepted danger and the startling tokens of its presence as the accompaniments, that only enhanced the majesty of the part he was called upon to play." At the battle of Copenhagen his superior officer signaled him to leave off action. "Leave off action!" he repeated, and then added, with a shrug, "Now damn me if I do!" He also observed, I believe to Captain Foley, 'You know, Foley, I have only one eye — I have a right to be blind sometimes,' and then with an archness peculiar to his character, putting the glass to his blind eye, he exclaimed, 'I really do not see the signal.'"<sup>1</sup>

This capacity for full expression of his impulses and emotions is thus due to the circumstance that at times his inhibitions were feeble. All sorts of emotions at such times were on the surface; repression was weak. Thus he often expressed, naively, his *longing for glory and distinction*. One of his friends, Lord Radstock, states: "A perpetual thirst of glory was ever raging within him" (Mahan, I, 152). While defending the Channel he writes to St. Vincent: "I feel myself, my dear Lord, as anxious to get a medal or a step in the peerage as if I had never got either. If I succeeded, and burnt the Dutch fleet, probably medals and an earldom." Before going into battle in the Mediterranean days he writes: "Before this time to-morrow I shall have gained a peerage or Westminster Abbey." To this love of glory, vanity is closely allied. Of the period about 1796 Mahan (I, 256) writes: "Already at times his consciousness of distinction among men betrays something of that childlike, delighted vanity, half unwitting, which was afterward forced into exuberant growth and distasteful prominence by the tawdry flatteries of Lady Hamilton and the Court of Naples."

This *abundant emotional output* is seen in his love affairs. At the age of 24 years in Canada, he fell desperately in love with a fair Canadian and would imprudently have offered to marry her had not a cool-headed friend successfully intervened. A year later in Paris he met a young Englishwoman, had an exaggerated sense of her good qualities, writes "the most accomplished woman my eyes ever beheld," and asks for money to enable him to marry; but the lady seems to have refused him. At the age of 27 years he met a young widow at Nevis, West Indies, and married her. Later, after the battle of the Nile, he became enamored of Lady Hamilton, a woman with a disreputable past, and lived with her publicly, causing his wife to divorce him. "Principle apart, — and principle wholly failed him, — all else," says Mahan (I, 67) "that most appeals to a man's self-respect and regard for the esteem of others was powerless to exert control. Loyalty to friendship, the sanctity which man is naturally fain to see in the woman he loves, and, in Nelson's own case, a peculiar reluctance to wound another — all these were trampled under foot, and ruthlessly piled on the holocaust which he offered to her whom he worshipped." This is the natural reaction where the inhibition — the self-control — is weak.

Nelson showed strong religious, emotional output, perhaps not to be wondered at in the son of a minister. This is strongest at times of great excitement. After the battle of the Nile he began his dispatch: "Almighty God has blessed His Majesty's arms." As he is departing for his last sea voyage, ending in Trafalgar, he writes in his diary: "May the great God whom I adore enable me to fulfill the

<sup>1</sup> Statement by Colonel William Stewart, in Mahan, II, 90.

expectations of my country; and if it is His good pleasure that I should return, my thanks will never cease being offered up to the Throne of His mercy, etc." (Mahan, II, 335). His ship's chaplain, who was also his confidential secretary, said: "He was a thorough clergyman's son — I should think he never went to bed or got up without kneeling down to say his prayers." He always had divine service on shipboard whenever the weather permitted (Mahan, II, 160).

A part of this same emotional output was his strong expression of affection for his men and fellow-officers. This was characteristic. When his squadron was striving to beat the French fleet to the West Indies he wrote to the captain of the slowest ship not to worry, he appreciated that his ship was doing all it could. When, on the eve of the battle of Trafalgar, he happened to learn that a midshipman had forgotten to post his letter on the naval frigate that was already under way for England, he had the frigate recalled to take the letter. Such thoughtfulness for his men won their loyalty and their enthusiastic support in the battles planned by him.

To the superficial observer Nelson thus appears as a strange contradiction. Lord Minto wrote of him: "He is in many points a really great man, in others a baby." The childish reaction of an adult is often referred to as the criterion of hysteria; and Nelson's behavior, at times, seems to fit more nearly that category than any other. The emotional characteristic of the hysterical is lack of control — easy excitability, with show of vanity, joy, affection, religion; but also sometimes overactive drive and fearlessness of consequences. On the physical side the hysterical often show temporarily numb areas on the skin or they suffer temporary paralysis. Such symptoms Nelson repeatedly suffered. After his trip to India (1776) he for some time lost the use of his limbs. This happened again in 1780. He writes in 1781: "I have now perfect use of all my limbs, except my left arm, which I can hardly tell what is the matter with it. From the shoulder to my fingers' ends are as if half dead." In 1801, on duty in the English Channel, he writes: "I have all night had a fever, which is very little abated this morning; my mind carries me beyond my strength, and will do me up; but such is my nature. I require nursing like a child" (Mahan, II, 139). He was apparently at other times subject to such fevers, which resembled the so-called hysteric fevers that follow great excitement.

Nelson was not only extraordinary temperamentally, but also intellectually. As Mahan (I, 83) says: "Good generalship, on its intellectual side, is simply the application, to the solution of a military problem, of a mind naturally gifted therefore, and stored with experience, either personal or of others." Now, Nelson's education, like that of most midshipmen who enlisted at 12 years of age, was unsystematic, and he never learned to express himself well in writing; but despite this he had the mental qualities of a "great intellect." His memory was tenacious, his observation close and constant, and he acquired knowledge by extensive intercourse with men and, like Napoleon I, by provoking others to debate and listening to the discussion (Mahan, II, 233). He also, especially in his hypokinetic moods, thought deeply and his mind naturally saw relations of cause and effect. Hence he was able to become a great *strategist*. At 30, even, he impressed the home office with the "justice and correctness of his views, the result, as they were, of reflection based upon a mastery of the data involved." He showed great capacity in diplomacy. At Naples, in 1793, he knew that troops were wanted at

Toulon and secured, without the knowledge of his superior officer, the promise of 6,000 Italians to meet this need. In Corsica, when the relations between the general and admiral became strained, he was the intermediary who secured the desired cooperation. It was so throughout life. His own affectionate, winning nature, his pertinacity, and thorough insight into the motives of men added to his success. The hypokinetic man is the intellectual ruminant, the philosopher, because in that state grosser movements are inhibited and there is time to think. Nelson's depressed states made him a strategist and statesman; his excited states made him a tactician and fighter.

The advantage of Nelson's *hysteroidal, feebly-inhibited temperament* for a great naval fighter is shown in the battle of Copenhagen in contrast with the calm, deliberate (normal) temperament of Sir Hyde Parker, who was in command of the expedition. Parker was very doubtful of the feasibility of attacking the enemy's strong force in Copenhagen harbor, but permitted Nelson to go with 12 battleships up close to the Danish ships and batteries; and against these Nelson fought so successfully that the Danes readily agreed to an armistice on terms practically of Nelson's dictation. The calm Parker, meantime, stands with the main fleet some 5 to 4 miles out and, without having fired a gun himself, signals Nelson in the midst of the battle to leave off action — a signal which Nelson deliberately disobeys. Nelson was able to throw precaution and other minor considerations to the wind in the excitement of the anticipated battle; but Parker could not do so and remained inactive.

Three other traits of Nelson remain to be discussed — ambition, sense of duty, and pertinacity:

*Ambition.* — The desire to excel arises from love of esteem, an *amour propre*, a dislike to be considered inferior. In extreme cases it leads, by perversion, to a desire for power and supremacy at any cost. The instinct to be first, doubtless, is a part of the sexual instinct. It shows itself in male animals which fight for leadership in the herd; such leadership gives them the choice in matings. It shows itself in females which make themselves as attractive as possible in order to secure attention from the males. It was strong, but not to a perverted degree, in Nelson. As a lad he would not be turned back from going to school by the deep snow, as his father relied on his honor to get through if possible. While second lieutenant, the captain called for volunteers to board a captured prize when the sea was running high. The first lieutenant failed in the attempt; Nelson succeeded and his success gave him the keenest satisfaction. Nelson expressed himself as "determined to climb to the top of the tree" and neglected no chance, however slight, that could help him on. Of this work at San Juan in Nicaragua he says: "I made batteries and afterwards fought them and was the principal cause of our success." Thus he shows a naïve, almost childlike delight in his own performances, which, indeed, he had not overstated. When on the North Atlantic station, after the American Revolution, he desired to be transferred to a squadron going to Jamaica, his chief reminded him that where he was was a good place to make prize money. "Yes," he replied, "but the West Indies is the station for honor" (Mahan, I. 37); and he said on another occasion: "True honor, I hope, predominates in my mind far above riches." Thus Nelson's ambition and insight combined led him to prefer the supremacy of achievement by daring and national aggrandisement to the supremacy of wealth.

*Sense of duty.* — This is closely related to ambition. In Nelson's case it was the appreciation of the fact that he must subordinate the immediate gratification to larger interests. As he tells his betrothed: "Duty is the great business of a sea officer — all private considerations must give way to it, however painful it is." Again, he writes to his wife: "I have pride in doing my duty well, and a self-approbation, which if it is not so lucrative, yet perhaps affords more pleasing sensations" (Mahan, 1, 133). His last signal at Trafalgar before "close action" was "England expects every man will do his duty," and his last words: "Thank God, I have done my duty; God and my country."

It is to be noted that his devotion to duty did bring him that fame which he idolized. If devotion to duty and fame did not achieve the end of a eugenical mating it was because a certain feebleness in the inhibition of the sex impulse led him to marry before he had acquired fame. It did make possible a later illegitimate mating, with Lady Hamilton, at a higher social level than the first, and its product was Horatia, his only child who survived infancy.

*Strength and tenacity of convictions.* — This trait is a part of the depressed temperament. The hyperkinetics readily and quickly change their ideas and even ideals, but the hypokinetics are tenacious of them. Nelson said: "I feel I am perfectly right, and you know upon these occasions I am not famous for giving up a point." As a captain in the West Indies he disputed the right of a civil officer — "Commissioner of the Navy" — to fly the commodore's pennant and to give him orders, and insisted on this principle. "Under a conviction of right he throughout life feared no responsibility and shrank from no consequences" (Mahan, p. 52). He stuck to his conviction that American ships, after the Revolution, had no right to trade in the British West Indies, although in doing so he opposed his naval superior and the civil governments of the islands. Finally the courts decided that his contention was correct. These instances are characteristic of his reactions throughout life.

Let us now consider the origin of the constitutional traits which determined Nelson's reactions. We look with interest for the traits of Nelson's descendants, and here we find few data. Of Horatia, generally regarded as his daughter by Lady Hamilton, it was observed by Nelson, Grenville, and Hamilton: "Horatia is like her mother; will have her own way, or kick up a devil of a dust." This insistence upon carrying out ideas was, of course, strongly seen at times in Nelson also. Horatia married Philip Ward and had a son, Nelson Ward, about whom details are wanting.

Nelson's fraternity comprised 11, of whom 3 died in infancy. Besides Horatio there were:

Maurice, born in 1753, who secured through the assistance of his mother's brother, Captain Maurice Suckling, a comptroller of the navy, a position as clerk in the navy office. Maurice was rather apt to be in debt and difficulties, from which he was once rescued by Horatio. It was not until he was over 40 that his father was able to write: "He has the income of a gentleman" (Matcham, 1911, p. 126). In 1801 he was promoted to the principal seat in the naval office and great regret was felt when he died, childless, shortly after.

Susannah (1755-1813), who married, in 1780, Thomas Bolton. She had a cheerful, affectionate, plucky temperament. She had 2 sons and 4 daughters. Of the sons Thomas became the second Earl Nelson and had many descendants, including Rear Admiral Maurice Horatio Nelson (1832-1906). George died at sea at the age of 12 years.

**William (1757-1835)**, who was an M. A. of Christ College, Cambridge, became rector of Little Brandon, 1773. In 1784 he tried sea-life as chaplain on his brother's ship *Boreas*, but not caring for the life he left after a voyage and returned to England, "thereafter living quietly and snugly" (Matcham, 1911, p. 20). He settled on the family advowson of Hilborough, was a prebendary of Canterbury and a doctor of divinity. On the death of the admiral he became the first Earl of Nelson and immediately assumed an attitude of ungraciousness that led to a temporary estrangement from his sisters. His only son died suddenly at the age of 20. His daughter Charlotte inherited the title, from the admiral, of Duchess of Bronté and married the second Baron Bridport, great-nephew of Admiral Alexander Hood. Despite this union of the strains of two of England's greatest admirals, neither her son Alexander nor any of her 6 grandsons showed exceptional performance.

**Anne (1762-1783)**, who died in her twenty-first year after nine days' illness, due to coming out of a ballroom immediately after dancing. (Matcham, 1911, 20.)

**Edmund (1762-1790)**, who was unenterprising and unsuccessful. He joined in partnership with his sister Susannah's husband in various undertakings, and died, unmarried, of tuberculosis.

**Suckling (1764-1799)**, who was "silent and reserved," good-natured, indolent, and fond of sport. He tried business with no success, was constantly in financial difficulties, and yet he was easily influenced for good. He took holy orders, was his father's curate, and died when still young and unmarried.

**Catherine (1767-1842)**, the "Kitty" of Nelson and his favorite sister, who was the most like him of any of the family — warm-hearted, energetic, petulant at times, thorough and content in domestic life, and constantly interested in men and things. In 1787 she married George Matcham (1753-1833), who was born in Bombay, where his father was superintendent of the marine of the East India Company. Sent early to London to school, Matchman entered the service of the company in India, traveled extensively, went from India to England overland, and finally settled in England, 1785, as a country gentleman, being especially interested in inventions and public improvements. Of their three sons, two attained some success in the law and one migrated to Australia, where he died.

Thus it appears that all four of Nelson's brothers were without the drive that characterized him; indeed, they were somewhat, or even strikingly, indolent and from them all was descended only one child, a daughter, who survived to marry. The sisters were livelier and two of them had descendants; but these descendants apparently showed few traits of the admiral. It would be interesting to learn more about Catherine's son, whose migration to Australia suggests a love of new scenes and perhaps ambition.<sup>1</sup>

On the paternal side Lord Nelson is said to have come from a family of clergymen. His father, Rev. Edmund Nelson (1722-1802), is shown by his letters (Matcham, 1911) to be a gentle, sweet-tempered English gentleman, interested affectionately in the affairs of his numerous children, who were early bereft of their

<sup>1</sup> Female lines in which a future admiral may arise are: 1, daughters of Susanna: *a*, Catherine, who married (1803) Capt. Sir William Bolton, Royal Navy; *b*, Elizabeth, who married Rev. Henry Girdlestone; 2, daughters of Catherine: *a*, Catherine, who married (1820) John Bendyshe, lieutenant, Royal Navy, of Cambridgeshire, and had 5 sons and 4 daughters; *b*, Elizabeth, who married (1824) Arthur Davies, post captain, Royal Navy; *c*, Harriet, who married (1819) Edward Blanckley, captain, Royal Navy; *d*, Horatia who married (1826) Henry W. Mason, lieutenant, Royal Navy; and *e*, Susannah, who married, 1832, Alexander M. Moore, of County Tyrone.

mother. He brought up his children with gentleness and religious instruction and followed them with frequent letters. To his boys he used to say: "Remember, I leave it to your honor." He won respect and affection from all. He was of a contented nature, but somber rather than jolly. Ambition, drive, dash, statesmanship were not his traits. His constitution was weak and sickly. His only brother died unmarried; one of his sisters married Rev. John Goult, rector of Hilborough, and their grandson was Robert Monsey, Lord Cranworth, a leading legal light, noted for his sound sense. The father's father, Edmund Nelson (1693-1747), was rector of Hilborough, Norfolk, and was without distinctive characteristics. Two of Horatio's first cousins on the Nelson side were clergymen. The father's mother was Mary, daughter of John Bland of Cambridge, gentleman, and sister to a chaplain of the Duke of Encaster. Thus, the paternal side shows no example of the striking traits revealed by the great admiral.

Let us examine the maternal side. His mother was Catherine Suckling, a woman of "some force of character" (Moorhouse, 1913, p. 9). Her brother, Captain Maurice Suckling, was an ambitious naval fighter; as we have seen, he married a distant cousin, Mary Walpole, but I have no record of any children. Another brother, William, had a grandson, William B. Suckling, who became a rear admiral.

The mother's father was Rev. Maurice Suckling, D. D., of whom I have no further data. His brother Robert had a great grandson, Maurice, who was in the Royal Navy.

The mother's mother was Anne Turner, of whose traits there is no information, but her mother was Mary Walpole, the sister of Sir Robert Walpole (1676-1745), England's great prime minister, created first Earl of Orford. On this side, then, we find ambition, great capacity for work, and the hyperkinetic drive. Another brother of Mary was Gilfridus Walpole (1683-1726), who commanded the *Lion*, of 60 guns, in a gallant action in the Mediterranean, in 1711. He died at the age of 43 years. Here we see a possible nomadic trait, love of adventure, and capacity for naval fighting.

While the gene for nomadism is sex-linked and may be carried in eggs through generations, but not in male zygotes, this is not true of the genes for hyperkinesis. Since there is no evidence of a hyperkinetic temperament in either parent, or even in the four grandparents, it seems probable that in Nelson that inhibition to danger, which is so marked in other members of the family, was prevented by a dominant mutation that permitted the weakening of such inhibitory mechanism.

#### FAMILY HISTORY OF HORATIO NELSON.

I 1 (M F F F), Robert Suckling, high sheriff of Norfolk. I 2 (M F F M), Anne Wodehouse. I 3 (M M M F), Robert Walpole (1650-1700), a prominent Whig in Parliament. I 4 (M M M M), Mary Burwell, daughter of Sir Jeffrey Burwell.

I 1 (M F F), Robert Suckling, high sheriff of Norfolk. II 2 (M F M), Sarah Skelton. II 3 (M M F), Sir Charles Turner, died 1738. II 4 (M M M), Mary Walpole, died 1711. *Fraternity of M M M*: II, 5 Robert Walpole, first Earl of Orford (1676(1745), the celebrated prime minister of England. II 6, Horatio Walpole (1678-1757), a diplomat of the first class. II 7, Galfridus Walpole, of the Royal Navy.

*Fraternity of M F*: III 1, Robert Suckling. III 2, Dorothy Berney. III 3 (M F), Rev. Maurice Suckling. III 4 (M M), Anne Turner, died 1768. III 5 (F F), Rev. Edmund Nelson (1693-1747). III 6 (F M), Mary Bland. *Fraternity of F M*: III 7, Rev. John Bland. III 8, Bryant Bland.

IV 1, Richard Suckling. IV 2, Anne Kibert. *Fraternity of M*: IV 3, Maurice Suckling, of the Royal Navy. IV 4, William Suckling. IV 5, Elizabeth Browne. IV 6 (M), Catherine Suckling (1725-1767). IV 7 (F), Rev. Edmund Nelson (1722-1802). IV 10, Rev. John Goulty.

V 1, Robert Suckling (died 1812), of the army. V 2, Susanna Webb. V 3, Colonel William Suckling (born 1762). V 5, Thomas Bolton. *Fraternity of Propositus*: V 6, Susanna Nelson (1755-1813). V 7, Anne Nelson (1762-1783). V 9, Maurice Nelson (born 1753), a clerk in the Navy Office. V 10, William Nelson (1757-1833), a rector. V 11, Sarah Yonge. V 12, Catherine Nelson (1767-1842). V 13, George Matcham (1753-1833), in the service of the East India Company. V 14, Edmund Nelson (1762-1790). V 15, Suckling Nelson (1764-1799), a curate. V 16 (consort), Frances Woodward. V 17 (*Propositus*), HORATIO NELSON. V 18, Lady Hamilton.

VI 1, Robert George Suckling, a captain, Royal Artillery. VI 2, Maurice Suckling (died 1820), of the Royal Navy. VI 3, Rev. John Suckling. VI 4, Anna Maria Suckling (1765-1848). VI 5, Sir Charles Burrard (1793-1870), an admiral of the Royal Navy. VI 6, Louisa Lushington. VI 7, William Benjamin Suckling, a rear admiral. VI 9, Catherine Bolton. VI 10, Sir William Bolton, of the Royal Navy. VI 11, Elizabeth Anne Bolton. VI 12, Rev. Henry Girdlestone. VI 13, Thomas Bolton (1786-1835), second Earl Nelson. VI 14, Frances Eyre. VI 15, George Bolton (1787-1799), died at sea. VI 17, Charlotte Nelson. VI 18, Samuel, second Lord Bridport. VI 19, Catherine Matcham. VI 20, John Bendyshe, a lieutenant, Royal Navy. VI 21, Elizabeth Matcham. VI 22, Arthur Davies, a post captain, Royal Navy. VI 23, Harriet Matcham. VI 24, Edward Blanckley, a captain, Royal Navy. VI 25, Horatio Matcham. VI 26, Henry Mason, a lieutenant, Royal Navy. VI 27, Susannah Matcham. VI 28, Alexander Moore. VI 29, George Matcham (born 1789), a lawyer and author. VI 30, Charles Horatio Matcham (1806-1844), went to Australia. VI 31, Nelson Matcham (1811-1886), a barrister-at-law. VI 32, Horatia Nelson. VI 33, Philip Ward. VI 43, Robert Monsey, Lord Cranworth.

VII 1, Emily Burrard. VII 2, Maurice Horatio Bolton (1832-1906), a rear admiral. VII 3, Horatio Bolton, third Lord Nelson. VII 4, John Horatio Bolton (born 1825), vicar of Scottow. VII 5, Rev. Edward Bolton (1833-1859). VII 6, William Henry Bolton (1835-1863). VII 8, Alexander Nelson Hood, first Viscount Bridport, a colonel of the Scots Guards. VII 11, Richard Bendyshe (born 1822), a curate. VII 14, Henry D. Blanckley, became a lieutenant in the navy in 1844. VII 15, Alexander Moore (born 1833), a general.

VIII 1, Maurice Henry Horatio Bolton (born 1864), a commander of the Royal Navy. VIII 2, Rev. Edward John Bolton (born 1867). VIII 3, Lieutenant Colonel Charles Burrard Bolton, born 1868. VIII 4, Horatio William Bolton (born 1871), registrar of the supreme court, Ceylon.

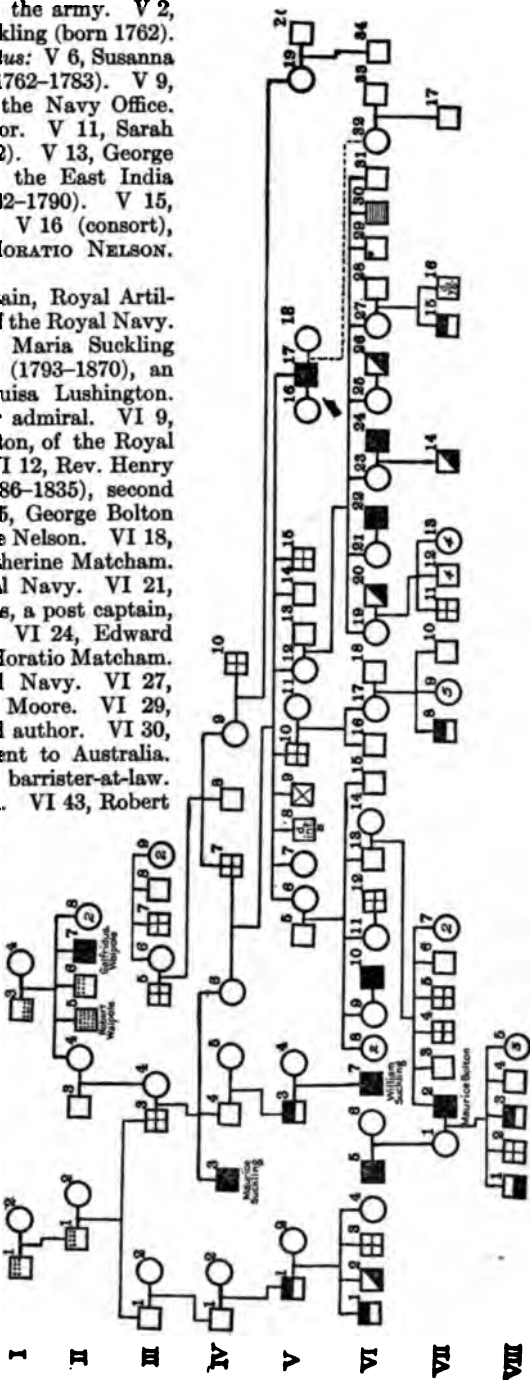



## BIBLIOGRAPHY.

- BURKE, SIR B., and A. 1909. A Genealogical and Heraldic History of the Peerage and Baronetage. London: Harrison and Sons. 2570 pp.
- BURKE, SIR B. 1914. A Genealogical and Heraldic History of the Landed Gentry of Great Britain. London: Harrison. 2102 pp.
- CALLENDER, G. 1912. The Life of Nelson. London: Longmans, Green & Co. xxxviii + 154 pp.
- MARAN, A. 1897. Life of Nelson. Boston: Little and Brown. 2 vols.
- MATCHAM, M. 1911. The Nelsons of Burnham Thorpe. London and New York: J. Lane. 306 pp.
- MOORHOUSE, E. H. 1913. Nelson in England, A Domestic Chronicle. New York: E. P. Dutton & Co. xi + 274 pp.
- NELSON, T. 1908. A Genealogical History of the Nelson Family with an Introduction by the Right Hon. The Earl Nelson. King's Lynn: Thew and Son.
- O'BRYNE, W. 1849. A Naval Biographical Dictionary. London: J. Murray. 1400 pp.
- RUSSELL, W. 1890. Horatio Nelson and the Naval Supremacy of England. New York: G. Putnam's Sons. xiv + 357 pp.

## 45. JEREMIAH O'BRIEN.

JEREMIAH O'BRIEN was born in 1744, at Kittery, Maine. As a young man he was engaged in lumbering and shipping and became a leader in the town. In June 1775 a Boston merchant, convoyed by a British armed schooner *Margaretta*, appeared at Machias for lumber. Having learned of the battle of Lexington and believing that the lumber would be used to fortify the British in Boston, the townspeople, led by the father of the propositus (Morris O'Brien), at first declined to sell, but later agreed to exchange lumber for the needed provisions that the merchant vessel carried; but the captain refused to sell food to the leaders of the opposition. This, and the demands of the officer in charge of the *Margaretta* that the liberty pole which the townspeople had erected should be taken down, stirred the resolution of the patriots. A number of the residents of nearby towns met at Morris O'Brien's house and decided to seize the *Margaretta*. One day a local sloop, the *Unity*, was filled with townspeople carrying various kinds of weapons, a small cannon was mounted on the deck, six of Morris O'Brien's sons went on board, and Jeremiah was elected captain. They ran alongside the *Margaretta*, boarded and captured her, and made her officers and crew prisoners. This was the first naval battle of the Revolution. When two armed sloops were sent out from Halifax, to capture O'Brien, he and Captain Foster, of the *Machias Liberty* and *Falmouth Packet*, respectively, captured the two sloops and brought them both to Machias. Then O'Brien took his prisoners to Portland by vessel and thence to Cambridge overland. Commissioned by the Massachusetts provincial congress, Jeremiah and John O'Brien, commanding the *Machias Liberty* and the *Diligence* (captured from the British), respectively, cruised for two years on the coast of the Gulf of Maine and captured various British vessels. In 1780 the brothers built the *Hannibal*, 24 guns, for privateering, but she was captured by two British frigates and Jeremiah was placed in the prison-ship *Jersey*. Taken to Plymouth, England, he escaped from prison and crossed the English Channel in a boat propelled by oars. He returned to Machias, where he remained the rest of his life as collector of customs. When, during the War of 1812, the British officers searched his house, he gave them refreshments and as they toasted the king he toasted success to the American arms. He died at Machias, September 1818.

*Brothers.* — John O'Brien, born in Scarborough, Maine, 1750, was one of the party that on June 12, 1775, captured the British armed schooner *Margaretta* off Machias. He was the first to board the *Margaretta* when the *Unity* collided with

her and, as the latter withdrew, was left alone on the enemy's ship. Seven muskets were discharged at him, but he was not hit; then they charged at him with bayonets, but he jumped overboard and swam to the *Unity* uninjured, despite the hail of balls from the British vessels. John was made first lieutenant on the *Vigilant* after she and the *Machias Liberty* had been fitted out. In 1780 he and his brother Joseph built the *Hannibal*, carrying 24 guns, for privateer service. John captured important prizes in her during her first cruise. As captain of various vessels he made numerous captures in the next year or two. Once, chased by a naval frigate into Long Island Sound, he ran up the Thames river (up which the frigate could not go at night because of her draft). He made a sort of raft, put lights upon it, and sent it down the river the same night; the frigate fired at it and sailed away concluding that it had sunk its opponent. After the war he settled in Newburyport and was ship-owner and captain; was a man of public affairs and charitable; he exercised a large hospitality and, by his contemporaries, is said to have had no idea of the meaning of fear. He died in 1826.

Gideon, born at Scarboro, Maine, January 14, 1746, was on the *Unity* in her capture of the *Margaretta*, and was a captain in the Continental army, 1782, being detailed at Machias. In 1822 he was elected representative to the Maine legislature.

William, also one of the *Unity* crew, always followed the sea and died at Bilbao, Spain, 1781. He married Lydia Clarkson (Widow Toppan) in 1790 at Newburyport, and had a daughter, Lydia, who was the mother of John Parker Hale. This grandson of William O'Brien (born at Rochester, Strafford county, New Hampshire, March 31, 1806) was graduated at Bowdoin, 1827 and entered law practice in 1830 and the legislature in 1832. In Congress, 1843-1845, he defended the right of petition and in 1845 he refused to vote for the annexation of Texas, against the direction of his State legislature. In 1846 he was again in the State legislature, was made speaker, and six days later elected to the United States Senate. There he was the first and for two years (1847-1849) the only avowed opponent of slavery. He was eloquent, witty, and full of good humor, which made him liked, despite his views. Always a reformer, between 1850 and 1852 he secured laws to abolish flogging and grog rations in the navy. He declined a presidential nomination by the Liberty party in 1847, but accepted that of the Freesoilers in 1852. In 1853 he removed to New York, but in 1855 went again to the Senate from New Hampshire and kept his seat there until 1865, gradually witnessing the success of the views early advocated by him. Sent to the court of Spain, he had some disagreements with the secretary of the legation that caused a scandal. Later mental as well as physical disorders appeared and he died in 1873.

Brother Dennis O'Brien also was one of the *Unity* crew, and, finally, Joseph, a lad of 16 years, the youngest, who was forbidden to go, but nevertheless secreted himself on the sloop, was a brave fighter in the attack on the *Margaretta*.

The most distinguishing character of this fraternity is *great daring and absence of fear*. Of Jeremiah an acquaintance said "a man who knew no fear." Again, "Captain Jeremiah O'Brien was as fearless as the king of the forest, not for a moment hesitating to throw himself into the forefront of any cause by him freely espoused or to face any peril, however great, toward which the voice of duty called him in the prosecution of that cause." Similarly, John O'Brien all alone, practically unarmed, leaps on a war vessel full of armed men — a rash and reckless act. So, too, the 16-year-old Joseph, though warned of danger, stows himself away to be

carried to the fight. And in later life we find the three older brothers active in the Revolution, on sea or land, in some of the most hazardous occupations.

Unfortunately nothing is known of the maternal side except that the mother's father was a sea captain. The father was at the siege of Louisburg, but was ordinarily a tailor and later a lumberman.

*Love of the sea* was marked in this fraternity; the lads were taught to sail a boat by their father.

It is clear that Jeremiah O'Brien is a typical *hyperkinetic*. "Into whatever undertaking he enlisted he threw his whole soul"; he was outspoken and fiercely patriotic, of a high sense of honor, a man of "that temperament which is susceptible of high excitement, constitutional ardor, spirit, full of fire."<sup>1</sup> "By temperament he was impulsive almost to the point of rashness and, in action, particularly when thoroughly aroused, he was impetuous and irresistible as the raging torrent — exhibiting at such times a forcefulness of character which under ordinary circumstances was not apparent to the casual observer." "Outspoken he was — and fear of consequences was never, so far as the author has been able to gather, allowed to bridle his tongue when once indignant feeling or great thought throbbed in heart or brain and pressed for utterance, and individual and aggregate of individuals found the same when once Captain O'Brien felt his keen sense of justice outraged."

FAMILY HISTORY OF JEREMIAH O'BRIEN.

I 1 (M F), — Keen, a sea captain sailing from Portsmouth, New Hampshire.  
I 2 (M M), died quite young.

II 1 (F), Morris O'Brien (1715-99), learned the tailor's trade, migrated from Ireland to United States in 1738. In 1750 he was in Scarboro, Maine; in 1765 he removed to Machias, where he started a sawmill and became a prosperous lumber man. He was present at the siege of Louisburg, 1745. When his sons went to attack the British vessel *Margaretta* he followed down the river in a rowboat with a surgeon. II 2 (M), Mary Keen.

*Fraternity of Propositus*: III 1, Mary O'Brien. III 3, Gideon O'Brien (born 1746), one of the *Unity* crew (see text). III 4, John O'Brien (born Scarboro, Maine, 1750) (see text). III 5, William O'Brien, (see text). III 6, Lydia Clarkson. III 7, Dennis O'Brien, one of the *Unity* crew. III 8, Joseph O'Brien, at the age of 16 years was on the *Unity* (see text). III 9, Martha O'Brien. III 10, Joana O'Brien. III 11, (*Propositus*), JEREMIAH O'BRIEN. III 12 (consort), Hannah Toppan.

IV 1, Lydia O'Brien. IV 2, — Hale. *Children of Propositus*: IV 3, Maria O'Brien. IV 4, Rev. Jeremiah Chaplin, president of Waterville College, Maine. IV 5, John O'Brien (1790-1866), was a captain of the marines in the War of 1812 and was confined for ten months in an English prison. Later he became superintendent of the Dead Letter Office in Washington, D. C.

V 1, John Parker Hale (see text).

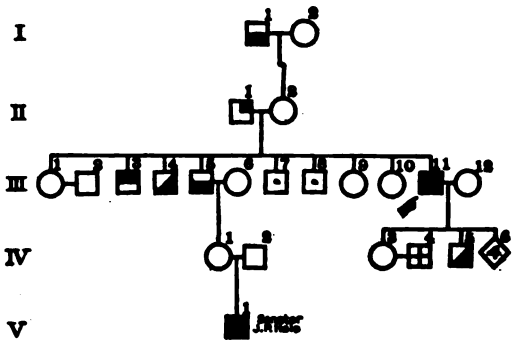

BIBLIOGRAPHY.

SHERMAN, A. 1902. Life of Captain Jeremiah O'Brien, Commander of the first American Naval Flying Squadron of the War of the Revolution.  
SMITH, W. B. 1863. Historical Sketch in Memorial of the Centennial Anniversary of the Settlement of Machias (Maine). Machias: C. Fairbush.

<sup>1</sup> Sherman, 1902, p. 105.

## 46. WILLIAM HARWAR PARKER.

WILLIAM H. PARKER was born in 1827. As a boy he read Marryat's novels, was always fond of adventure, of hearing and telling stories, and of fun. He entered the navy as a midshipman in October 1841, at the age of 14 years, and was ordered to the *Carolina*, one of Matthew C. Perry's squadron, where he studied navigation. In 1846 he was on the *Potomac*, sent to Port Isabel to support General Taylor. In 1847-1848 he studied at Annapolis. After passing his examination and in search of adventure, he selected a sloop-of-war going to Africa rather than a fine frigate for the Mediterranean. When an American brig dragged ashore in a storm, young Parker rowed over to her in a gale and helped save her. In 1853 to 1857 he was an instructor in mathematics at the Naval Academy and afterwards in navigation and astronomy, then in seamanship and naval tactics. In April 1861 he resigned his lieutenant's commission and joined the Confederates and was attached to the Beaufort squadron. He participated in the battle of Roanoke island and the weak defense of Elizabeth City. In command of the *Beaufort*, he participated in the battle between the *Merrimac* and the *Cumberland* and *Congress* the day before the *Monitor* arrived in Hampton Roads. He was called on for the examination and classification of midshipmen in the Confederate Navy and, in July 1863, he organized the Confederate Naval Academy, of which he was superintendent until the fall of the Confederacy. At the fall he and his naval men guarded the coin chest of the Confederacy for over 30 days. He was in the service of the Pacific Mail Company from 1865 to 1874, and for a time the captain of a steamer running between Panama and San Francisco. He was the author of several works on naval tactics and in 1883 published his entertaining "Recollections of a naval officer." He died suddenly in 1896.

Captain Parker had 4 brothers: (1) Robert. (2) Foxhall Alexander, who was executive officer at the Washington navy yard at the outbreak of the Civil War and did much to protect Washington in the early days of the war; he became a commodore in the United States navy, and chief signal officer; commanded the Boston navy yard in 1877-1878, and was superintendent of the Naval Academy at Annapolis at the time of his death in 1879. Like his brother William, he had literary gifts. He wrote two books on tactics and two on the howitzer, all of which are used as text-books in the Naval Academy. A son, William H., is in the navy. (3) Richard, who was a young man of fine intellect, became master in the United States volunteer navy. (4) Daingerfield, who entered the army in 1861 and was breveted for gallantry at Gettysburg; he became a colonel of infantry and retired in 1896. Thus this was a fraternity of *fighters and administrators*, with a preference, on the whole, for the sea.

The father of William H. Parker's fraternity was Foxhall Alexander Parker, who rose to the highest rank (commodore) of his day in the United States navy. The mother was Sara, daughter of General Robert Bogardus, of New York City, who was colonel of the Forty-first regiment of infantry in the War of 1812. The father's father was William Harwar Parker (born in 1752), who was an officer in the Virginia navy. Two of the latter's sons became brilliant lawyers, one a United States senator. In his fraternity all the males were fighters. These are all descended in the male line from George Parker, who early settled in Accomac county, Virginia, from whom also are descended the Parker-Upshurs.

To the latter branch belongs Thomas Parker, a captain of infantry at Germantown (1777); he was captured by the British and, as the British commander rode along and asked each of the Americans what his occupation was, Parker stood erect and said: "I am, as my father before me was, a gentleman, and be d—d to you!" His brother George was a judge. A sister, Anne Parker (born 1763), married Littleton Upshur and had a large family. One of her sons, George Parker Upshur (1799–1852), rose in the United States navy to the rank of commander. Another, Abel Parker (1790–1844), went with his brother Arthur to Yale, but left and entered Princeton in 1806. Abel was suspended, along with ten others, as a leader of resistance to the authority of the college. He studied law under William Wirt and was admitted to the bar in 1810. Abel had a sister who married a Mr. Nottingham and had a son, John Henry, who changed his surname to Upshur at the time he was appointed midshipman, November 1841. He participated in the Mexican war under Commodore Perry and, as lieutenant on the frigate *Cumberland*, helped to suppress the African slave-trade in 1858–1859. During the Civil War he was on the blockading squadron, helped to reduce the forts at Hatteras Inlet, North Carolina, and Port Royal, led successful expeditions up the rivers of South Carolina, and participated in the capture of Fort Fisher in 1865. He was created rear admiral in 1884, was commander in chief of the Pacific squadron in 1884 and 1885, retired at his own request June 1885 (N. C. A. B., iv, 316), and died May 1917. It is noteworthy that John Henry's fighting qualities came through the maternal side.

## FAMILY HISTORY OF WILLIAM H. PARKER.

*Common ancestor*, Captain George Parker, high sheriff of Accomac county, Virginia.

I 1 (F F F F), Dr. Alexander Parker. I 2 (F F F M), Susanna.

II 1 (F F F), Judge Richard Parker (died 1815). II 3 (F M F), — Sturman. II 4 (F M M), — Foxhall.

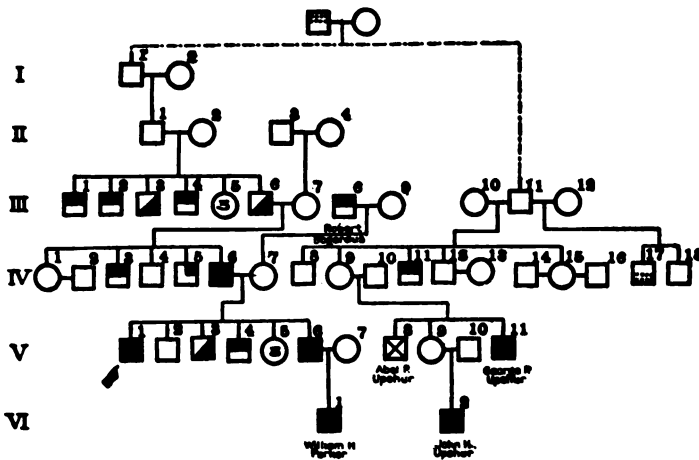

*Fraternity of FF*: III 1, Richard Parker (born about 1752), entered the army in 1776 and became a colonel of the First Virginia regiment. He was killed at Charleston, South Carolina. III 2, Alexander Parker, was a colonel of the Fifth Infantry, United States army; resigned 1809. III 3, John Parker, was drowned while attempting to board his ship. III 4, Thomas Parker, commanded the forces at Norfolk, Virginia, in 1813 or 1814. III 6, William Harwar Parker (1752 (?)–1840), was an officer in the Virginia navy during the Revolution, commanding

a vessel. After the war he returned to his plantation. III 7, Mary Sturman. III 8, General Robert Bogardus, a distinguished lawyer and colonel of the Forty-first regiment of infantry (Regulars) in the War of 1812. III 10, Ada Bagwell. III 11, George Parker (1735-1784). III 12, Susan Andrews.

*Fraternity of F*: IV 1, Juliet Parker. IV 2, Le Roy Daingerfield, a first cousin. IV 3, Robert Elliot Parker (died 1840), was a colonel in the War of 1812; a judge of the court of appeals and United States Senator. IV 4, John Parker. IV 5, William Chilton Parker, a brilliant orator and lawyer, who served in the War of 1812. IV 6 (F), Foxhall Alexander Parker (born ca. 1789), entered the navy and rose to highest rank of his day — commodore. IV 7, Sara Bogardus. IV 8, George Parker (died in infancy). IV 9, Anne Parker, born 1763. IV 10, Littleton Upshur. IV 11, Captain Thomas Parker, who was captured at Germantown (see text). IV 12, George Parker (1761-1826), a judge. IV 13, Margaret Eyre. IV 14, — Reed. IV 15, Elizabeth Parker. IV 16, — Teackle. IV 17, John A. Parker (born 1779), a member of the house of delegates. IV 18, Jacob Parker (born 1782).

V 1 (*Propositus*), WILLIAM H. PARKER. *Fraternity of Propositus*: V 2, Robert Bogardus Parker. V 3, Richard LeRoy Parker, was master of a vessel in the United States (volunteer) navy. V 4, Daingerfield Parker, entered the army in 1861 and became colonel of the Eighteenth Infantry, retiring in 1896. He was breveted for gallantry at Gettysburg. V 6, Foxhall Alexander Parker, a commodore in the United States navy. V 8, Abel Parker Upshur (1790-1844), a lawyer who was appointed secretary of the navy in 1841. V 9, — Parker. V 10, — Nottingham. V 11, George Parker Upshur (1799-1852), entered the navy as midshipman in 1818 and became a commander in 1847, when he had charge of the United States Naval Academy at Annapolis.

VI 1, William Harwar Parker, became lieutenant commander in the United States navy. VI 2, John Henry Upshur (1823-1917), assumed his mother's name. He accompanied Perry to Spain and was active in the Civil War (see text). He spent the later years of his life in Washington.

## BIBLIOGRAPHY.

- MCCABE, R. 1901. Abel Parker Upshur. (The John P. Branch Historical Papers of Randolph-Macon College. Richmond: E. Waddey Co.) pp. 188-205.
- PARKER, W. 1883. Recollections of a Naval Officer (1841-1865). New York: C. Scribner. 372 pp.
- SHEFFER, R. 1898. The Parker Family. Va. Mag. of Hist. Vol. VI, pp. 301-307, 412-418.

## 47. HIRAM PAULDING.

HIRAM PAULDING was born December 11, 1797, at Cortland, Westchester county, New York. He lost his mother at the age of 8 years. His boyhood was spent on a farm. He early desired to enter the army, but finally accepted an appointment in 1811 to enter the navy as midshipman. Here he studied mathematics and navigation. Ordered in 1813 to report for duty on the northern lakes, he saw service on the *Ticonderoga* and as lieutenant had charge of the quarter-deck guns in the great battle of Lake Champlain, and when the "matches" for firing the guns gave out he substituted the flash of his loaded pistol. He was highly praised for his bravery and received from Congress a sword and prize-money. In 1815 he was on the frigate *Constellation* under Commodore Decatur, which captured the Algerine cruisers, and the next year he was commissioned lieutenant. He then cruised for five years, and later took a year or two on land for further schooling at the military academy at Norwich. On a four-year cruise in the frigate *United States* he performed special service in conveying secret dispatches from Commodore Hull to General Bolivar, traveling nearly 1,500 miles on horseback, through a wild, mountainous country. He wrote an account of this trip, entitled "Bolivar in his Camp." Next he was assigned to the schooner *Dolphin*, commanded by John Perceval, to search for the mutineers of the whaleship *Globe*. When the two survivors were found, Paulding seized one of them in the face of hundreds of natives armed with spears and clubs and, covering his own body with that of his captive, marched to the boat, holding a cocked pistol to the ear of his prize. In 1831 Paulding wrote an account of this experience, full of interest and humor. After various minor cruises he was ordered, in 1848, to command the *St. Lawrence* and cruise along the coast of Europe. Here he exercised the arts of diplomacy and received on board several young Prussians for instruction in nautical affairs; one of these later became commander in chief of the German navy. The *St. Lawrence* also visited Southampton. From 1851 to 1854 Paulding was in command of the navy yard at Washington. During 1855 he was in command of the home squadron and cruised in the West Indies. In 1857 he visited Nicaragua in the *Wabash*, and in December of that year secured the surrender of the filibuster General William Walker. For this act he was given a sword by the president of Nicaragua; but the War Department disapproved and relieved him of his command; so he retired to Huntington, Long Island.

After the inauguration of Lincoln, Paulding was called upon to take charge of the Bureau of Detail. Here he arranged for the building of ironclads. He urged the building of the *Monitor* from Ericsson's plans. On the secession of Virginia he was sent to the Norfolk navy yard and took out of the navy yard what little could be saved; he destroyed the rest, and towed the *Cumberland* to safety. The navy yard was then completely destroyed by fire. In December 1861 he was retired by law, having reached the age limit, and in July 1862 he was created rear admiral. He commanded the Brooklyn navy yard, 1861 to 1863; here he pushed forward the fitting out of the *Monitor* and dispatched her to Fortress Monroe, withholding contrary dispatches received just before her departure. When the draft riots occurred in New York City, Paulding dispatched two companies of marines and placed small gunboats with light armaments at the foot of the principal streets. In 1866 he was sent to the Naval Asylum at Philadelphia as governor, and in 1869 was appointed port admiral of Boston, which post he held for a time. He died October 20, 1878.

Paulding was of a *buoyant temperament*, took a cheerful and hopeful view of things, and was ready for fun; but he had a horror of practical jokes and of puns. He often said: "Life is too short for controversy."

Hiram Paulding married, in 1828, Anne M. Kellogg, of Flatbush, New York, who had been educated by her father, Jonathan W. Kellogg, a graduate of Yale and the headmaster of Erasmus Hall in Flatbush. They had 6 children: (1) Anna; (2) Tattnell, who was colonel of the Sixth Cavalry, United States army, and served throughout the Civil War. He married Hannah Huddell and had a son John, who is in the insurance business and is fond of sailing, and a daughter Caroline, who married Lieutenant Raymond Naile; (3) Rebecca, married Lieutenant Richard Worsam Meade (born 1837), became a vice admiral, United States navy, and was the author of two books, one on "Boat Exercises" and one on "Naval Construction." Among their children are: (a) Clara, married to George Breed, who was a graduate of Annapolis, but who resigned from the navy to go into electrical work, and has 3 sons, all of whom are naval officers; (b) Richard W., who served in the Spanish-American War and in the Naval Reserve; is now president of the Fifth Avenue omnibus line, New York City; (4) Mary Paulding, who married Robert L. Meade, brother of Richard, and brigadier general of United States marines. (Another brother, Henry Meigs Meade, is paymaster in the United States navy; their father was in the navy and helped lay out San Francisco.) Mary had 4 children: (a) May and (b) Henrietta are appealed to by form and color and do beautiful work inlaying butterflies, etc. Neither of the sons, (c) Robert, who died at 38 years, or (d) John, was interested in the navy, though they sailed boats. (5) Hiram, who was not fond of the water and did not learn to sail a boat; he married Virginia Mulligan and has 3 daughters and a son Hiram 3d, who is fond of farming and also of the water and is a scoutmaster. (6) Emma, who likes to help organize and promote undertakings for the good of the community.

Of Hiram Paulding's sibs little is known. George was apparently a farmer, and Leonard was a naval officer of merit and distinction and showed marked gallantry at the capture of forts Donelson and Fisher. He was a man of charming character, beloved by all who knew him. His father was John Paulding (1758-1818), who in 1775 was a private in a militia regiment and at the close of the Revolutionary war was a major of militia. While patrolling the Hudson with two others, John Paulding captured Major André, found the incriminating papers from Benedict Arnold upon his person, refused the bribe he offered them for his release, and brought him to headquarters. John Paulding was thrice captured by the British. By his second wife, Esther Ward, he had Hiram and Leonard Paulding, naval fighters, and 4 other sons. It is probable that the *dash, fearlessness, and nomadic tendencies* of Hiram Paulding came chiefly from his mother's side though strengthened from the paternal side.

#### FAMILY HISTORY OF HIRAM PAULDING.

I 1 (M F), Caleb Ward (1728-1792), of Peekskill, New York. I 2 (M M), Mary Drake (1731-1801), daughter of Benjamin Drake.

*Fraternity of M:* II 1, Benjamin Ward (1750-1817). II 2, Abigail Ward. II 3, Solomon Fowler. II 4, John Ward (1752-1846), an officer in the Loyal American regiment who entered the service of the Crown as early as 1776. During the Revolution he was frequently in battle. In 1783 he settled in New Brunswick, where he became a citizen and merchant of renown. II 5, Phoebe Ward. II 6, Samuel Jones. II 7, Mary Ward. II 8, James Perrott. II 9 (M), Esther Ward, died 1804. II 10 (F), John Paulding (1755-1818), a major of the militia and one of the capturers of Major André. II 11 (consort's F), Jonathan Kellogg, headmaster of Erasmus



Hall. II 12 (consort's M), Mary Tuttle. II 13, Richard Meade (born 1778), navy agent and consul at Cadiz, Spain. II 15, Henry Meigs, a volunteer in the War of 1812, was commissioned adjutant. He was a member of Congress, president of board of aldermen, and recording secretary of the American Institute. II 16, Julia Austin, of Philadelphia.

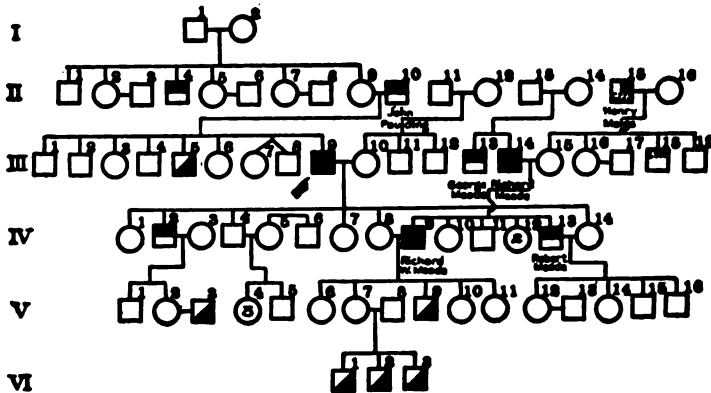

*Fraternity of Propositus:* III 1, George Paulding, born 1791. III 2, John Ward Paulding, born 1793. III 3, Sarah Teed Paulding, born 1796. III 4, James Paulding, born 1794. III 5, Leonard Paulding (born 1799), a naval officer. III 6, Mary Paulding (1802-1803). III 7, Susan Paulding (1804-1834). III 8, Caleb Paulding (born 1804), a farmer. III 9 (*Propositus*), HIRAM PAULDING. III 10 (consort), Anne Marie Kellogg. *Fraternity of consort:* III 11, Warren Comstock Kellogg, an insurance agent. III 12, George Kellogg, a physician. III 13, George Gordon Meade (1815-1872), a major general of the United States army, who commanded the Army of the Potomac at Gettysburg and to the end of the Civil War. III 14, Richard W. Meade (1807-1870), a captain in the United States navy. III 15, Clara Forsythe Meigs. III 16, Julia Austin Meigs, had musical ability. III 17, Walter Oddie, a landscape artist. III 18, Henry Meigs (born 1809), was president of the New York Exchange. III 19, Theodore Meigs (born 1814), was paying teller of the Bank of America.

*Children of Propositus:* IV 1, Anna Paulding, was interested in philanthropic work; a woman of great strength of character. IV 2, Tattnall Paulding. IV 3, Hannah Huddell. IV 4, Hiram Paulding, a farmer. IV 5, Virginia Mulligan. IV 6, Richard Mulligan, a physician. IV 7, Emma Paulding, greatly interested in philanthropic work. IV 8, Rebecca Paulding, compiler of her father's biography. IV 9, Richard W. Meade (born 1837), a rear admiral of the United States navy. IV 11, Henry Meigs Meade, born 1840. IV 12, Mary (born 1845) and Clara (born 1849) Meade. IV 13, Robert Learny Meade (born 1841), a brigadier general, United States Marines. IV 14, Mary Paulding.

*Children's children of Propositus:* V 1, John Paulding. V 2, Caroline Paulding. V 3, Raymond Neale. V 4, Helen, Julia, and Virginia Paulding. V 5, Hiram Paulding. V 6, Anna Meade. V 7, Clara Meade. V 8, George Breed, who is serving in the navy. V 9, Richard Meade. V 10, Rebecca Meade. V 11, Charlotte Meade. V 12, Henrietta Meade. V 13, — Wootton. V 14, May Meade. V 15, Robert Meade. V 16, John Meade.

*Children's children's children of Propositus:* VI 1, Richard Breed, a graduate of Yale, is now in the Coast Guard service. VI 2, Edward Breed, who was graduated from Annapolis, is an ensign, United States navy. VI 3, — Breed, was graduated from the Naval Academy, Annapolis, 1917.

#### BIBLIOGRAPHY.

- BOLTON, R. 1881. History of County of Westchester, New York. New York: C. F. Roper. 2 vols.  
 MEADE, MRS. R. 1910. Life of Hiram Paulding. New York: Blake & Taylor Co. ix + 321 pp.  
 MEIGS, H. 1901. Record of the Descendants of Vincent Meigs. Baltimore: J. Bridges. 374 pp.

## 48. EDWARD PELLEW.

EDWARD PELLEW was born at Dover, England, April 19, 1757. He lost his father in 1765 and at 11 years of age was, with his brothers, thrown upon the world.

“The resolute, active, and courageous character of the lads, however, brought them well forward among their equals in age. At school Edward was especially distinguished for fearlessness. Of this he gave a marked instance, when not yet twelve, by entering a burning house where gunpowder was stored, which no other of the bystanders would approach. Alone and with his own hands the lad brought out the powder. A less commendable but very natural result of the same energetic spirit was shown in the numerous fighting matches in which he was engaged. If flogged, he declared, he would run away; and as a decided taste for a seafaring life had already manifested itself, his guardian thought better to embrace at once the more favorable alternative and enter him regularly in the navy.” (Mahan 1913.)

On his first cruise in the Mediterranean, a midshipman was set ashore at Marseilles on account of a quarrel with the commander of the ship, who was grossly in the wrong. Pellew insisted on accompanying his messmate and at the age of 14 years had to find his way home. Assigned to the ship that was to take Burgoyne to America in 1775, he startled the general, who saw him standing on his head on a yard-arm. He dived from a yard-arm of a fast-moving ship to save a seaman who had fallen overboard and succeeded in rescuing him.

Pellew saw active service on Lake Champlain in 1776, when the command of the *Carleton* fell to him, and he fought with skill and pertinacity. On one occasion the *Carleton* lay close to shore, so that the wind did not fill her jib. Pellew sprang out on the bowsprit in the face of a hail of rifle bullets from shore to bear the jib over. Returning to England, Pellew was made lieutenant and served again under Captain Pownoll on the frigate *Apollo*. In a fight with the French frigate *Stanislas* Pownoll was killed and the command fell on Pellew, who fought until the enemy's ship went aground and claimed protection of the neutral flag. Later he drove ashore and destroyed several French privateers and was made post captain. Peace followed (1783–1793), and Pellew tried farming, but it was too slow for him. For five years of this period he commanded frigates. He showed himself as active as the youngest sailors among the yards and rigging. Once, dressed in full uniform to attend a state dinner on shore, Pellew watched the crew swimming around the ship while one of the ship's boys on deck called out to the bathers that he would soon have a good swim too. “The sooner the better,” said Pellew, coming behind and tipping him overboard. Then he quickly saw that the lad could not swim, so in he went himself, with all his fine clothes on, to rescue the boy. Pellew had remarkable capacity in handling a ship; and this did not fail him in his first battle as full-fledged commander of a frigate, the *Nymphe*. She came on the French *Cléopâtre*, and, sailing alongside of her, engaged her in a duel. The French frigate lost wheel and mizzenmast and, thus uncontrolled, ran straight into the *Nymphe*. The British boarded and captured her. Pellew was knighted, and his brother Israel, who had assisted him, was made post captain. In continuing the war with France, Pellew repeatedly showed acts of personal bravery and bold artifice, as when he personally saved the passengers and crew of a merchantman who had gone on the shore at Plymouth, and when he sailed into the French fleet

at night and, by making false signals, confused and rendered futile the signals of the commander in chief. Accompanied by the *Amazon*, Pellew in the *Indefatigable* fell upon the French frigate *Droits de l'Homme*, returning from Ireland toward France. With one frigate on the right and the other on the left of their quarry they forced it through a thick and gloomy night in a westerly gale upon the west coast of France. The *Amazon* could not beat her way off against the wind and was also lost on shore, but the *Indefatigable*, after a fight with the gale for 24 hours, cleared the last promontory and escaped serious damage. In 1802 Pellew was a member of Parliament. In 1804, having been created rear admiral and commander in chief in India, he cleared the Indian ocean of French cruisers. In 1814 he was created Baron Exmouth. In 1816 he destroyed the Algerine fleet, shattered the sea defenses of Algiers, and forced the Bey to liberate the 3,000 white men he held as slaves. For this victory Pellew was made viscount. He was shortly after retired and made vice admiral of England. He engaged in various activities and died in 1833. He married Susannah Frowde, and had 4 sons, of whom 2 became clergymen and 2 naval officers, respectively admiral and captain. A son of the latter died at 28, a lieutenant in the navy.

Of Edward Pellew's brothers, Israel became an admiral. He had distinguished himself under Nelson at Trafalgar and on other occasions. Another brother was a surgeon, and another, as ensign, was early killed in the battle of Saratoga. The father of this fraternity was Samuel Pellew, who commanded a post-office and packet on Dover Station. His mother was a Langford. Of the reactions of the parents and their families little is known.

Pellew was a typical *hyperkinetic*. He was not a great strategist, but a brilliant, dashing frigate commander, corresponding to a cavalry leader on land. A hyperkinetic tendency must, we may infer from other studies, have shown itself in one or both of his parents.

"Throughout his youth the exuberant vitality of the man delighted in these feats of wanton power. To overturn a boat by press of canvas, as a frolic, is not unexampled among lads of daring; but it is at least unusual, when a hat goes overboard, to follow it into the water, if alone in a boat under sail. This Pellew did, on one occasion, when he was old enough to know better, being at the moment in the open channel, in a small punt, going from Falmouth to Plymouth. The freak nearly cost him his life, for, though he had lashed the helm down and hove-to the boat, she fell off and gathered way whenever he approached. When at last he laid hold of her rail, after an hour of this fooling, barely strength remained to drag himself on board, where he fell helpless, and waited long before his powers were restored. It is trite to note in such exhibitions of recklessness many of the qualities of the ideal seaman, though not so certainly those of the foreordained commander-in-chief. Pellew was a born frigate captain."<sup>1</sup>

#### FAMILY HISTORY OF EDWARD PELLEW, FIRST VISCOUNT EXMOUTH.

I 1 (FFF), — Pellew, a captain in the navy.

II 1 (FF), Humphrey Pellew (died 1721), a merchant of importance who had a tobacco plantation on Kent Island, Maryland. II 2, Judith Sparnon (died 1753). II 3, (MF), Edward Langford.

III 2 (F), Samuel Pellew (born 1712), commanded the post-office and a packet on Dover Station. III 3 (M), Constantia Langford. III 4, James Frowde.

*Fraternity of Propositus*: IV 1, Samuel Pellew, a collector at the port of Falmouth; surgeon at the stockyards, Plymouth. IV 2, Sir Israel Pellew (died 1832), an admiral in the Royal Navy.

<sup>1</sup> Mahan. 1913. Page 432.

He commanded the *Conqueror* at Trafalgar and distinguished himself on other occasions. III 3, Mary Gilmore. IV 4, John Pellew, an ensign in the army, was killed at the battle of Saratoga. IV 5, Catherine Pellew. IV 6, Charles Louis, Count Jejerskjold, vice admiral of Sweden. IV 7, Jane Pellew. IV 8, Lieutenant Spriddle, of the Royal Navy. IV 9 (*Propositus*), EDWARD PELLEW, FIRST VISCOUNT EXMOUTH. IV 10, Susannah Frowde, (died 1837). IV 11, Mungo Dick.

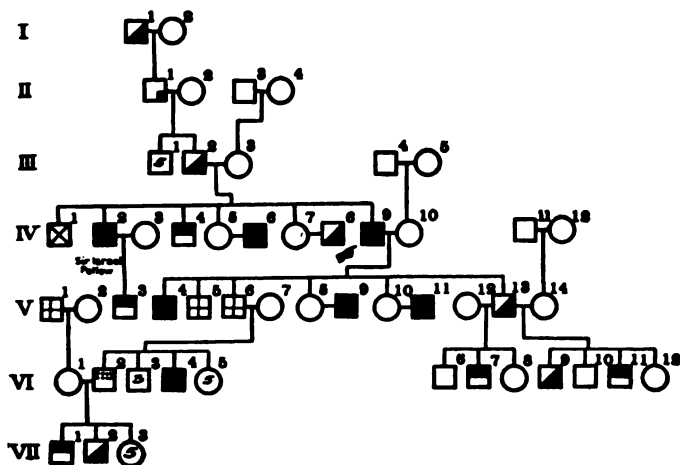

V 1, Rev. Philip Anderson. V 3, Edward Pellew, a captain in the army, was killed in a duel. *Children of Propositus*: V 4, Fleetwood Broughton Pellew (1789-1861), an admiral of the blue. V 5, George Pellew (1793-1866), dean of Norwich and prebendary of York; author and divine. V 6, Edward Pellew (1799-1869), a clergyman. V 7, Marianne Winthrop. V 8, Emma Mary Pellew (died 1835). V 9, Admiral Sir Lawrence William Halsted. V 10, Julia Pellew (died 1831). V 11, Richard Harward, a captain of the Royal Navy. V 12, Harriet Barlow. V 13, Pownoll Bastard Pellew, second Viscount Exmouth (1786-1833), a captain in the Royal Navy. V 14, Georgiana Dick.

*Children's children of Propositus*: VI 1, Dorothy M. Anderson. VI 2, Fleetwood Hugo Pellew (1838-1906), a commissioner of Dacca. VI 3, Edward (1830-1880), Rev. George Israel (born 1831), and Arthur Samuel (1841-1897) Pellew. VI 4, Pownoll William Pellew (1831-1872), a commander in the Royal Navy. VI 6, Edward Pellew, third Viscount Exmouth (1811-1876). VI 7, Percy T. Pellew (1814-1843), an officer in the Madras cavalry. VI 8, Juliana Pellew. VI 9, Pownoll Fleetwood Pellew (1823-1851), a lieutenant in the Royal Navy. VI 10, Fleetwood John Pellew (1830-1866). VI 11, Barrington Reynolds Pellew (1833-1858), was a major who served with distinction in the Kaffir war, at the siege of Sebastopol, the storming of Canton, and at the assault and capture of Lucknow, where he was killed. VI 12, Caroline Emma Pellew (died 1832).

*Children's children's children of Propositus*: VII 1, Fleetwood Hugo Pellew (born 1871), a captain in the army. VII 2, John Edward Pellew (born 1886), of the Royal Navy.

BIBLIOGRAPHY.

BURKE, SIR B., and A. 1909. A Genealogical and Heraldic History of the Peerage and Baronetage. London: Harrison and Sons. 2570 pp.  
 MAHAN, A. 1913. Types of Naval Officers drawn from the History of the British Navy. Boston: Little, Brown and Co. xiv + 500 pp.

## 49. GEORGE HAMILTON PERKINS.

GEORGE HAMILTON PERKINS was born December 20, 1836, at Hopkinton, Merrimack county, New Hampshire. He was an active country boy, not partial to books. At 15 years he entered the Naval Academy at Annapolis, October 1851, being graduated there in 1856, after taking an extra year's work, with "the lowest stand made in his class." He was assigned to the sloop *Cyane*, which went to the isthmus of Panama to preserve order; thence he transferred to the bark *Release*, on which he went to the Mediterranean and then to Paraguay. In April 1859 he successfully achieved the grade of passed midshipman, and four months later went to the west coast of Africa in the *Sumter*, to help suppress the slave-trade. There he suffered shipwreck and fevers and returned home, already a lieutenant and with an acquired taste for reading, in the autumn of 1861. In February 1862 he began service on the gunboat *Cayuga*, 500 tons, which went to the mouth of the Mississippi river and attempted, with other ships, the ascent to New Orleans. With Perkins as pilot, the *Cayuga* took the lead in passing Forts Jackson and Philip, which guarded New Orleans on the south. On board was Captain Bailey also, in charge of the first three divisions of the fleet. The *Cayuga* and the other ships passed at night with few casualties, despite a terrific bombardment by the forts. Reaching New Orleans, Captain Bailey and Perkins, without guard or arms, walked through the streets, surrounded by a howling, threatening mob, to the city hall and arranged for raising the Union flag. They returned unharmed. For gallantry in this affair Perkins was promoted to be lieutenant commander. He was now assigned to blockade duty at the mouth of the Mississippi, from June 1862 until the summer of 1863, when he was given command of the gunboat *New London*, which passed up and down the river carrying powder to Banks's army. She passed a Confederate battery five times successfully, but on the sixth her boiler was pierced and exploded. Nevertheless, Perkins saved both ship and men. Placed now in command of the gunboat *Scioto*, he engaged in blockade duty from July 1863 to April 1864, capturing a prize. Given charge of the monitor *Chickasaw*, he participated in the battle of Mobile Bay, in which his boat was hit several times. When the Confederate armed ram *Tennessee* attacked the fleet, Perkins was told to go in and fight it, the other monitors being out of action. In this fight the *Chickasaw* worked her guns at 50 to 10 yards from the ironclad. One of her shots carried away the *Tennessee's* smokestack, an 11-inch shell jammed her turret, and another destroyed the steering-gear; no one was hurt on the *Chickasaw*. A few hours later the *Chickasaw* advanced on Fort Powell, guarding the entrance to the bay, steamed to within 100 yards of it, and reduced it so that it was evacuated and blown up by the defenders during that night. Perkins remained on duty in Mobile bay until the end of the war and then returned home. During 1865-1866 he was superintendent of ironclads at New Orleans; then followed a 3 years' cruise to the Pacific on the *Lackawanna*. From 1869 to 1871 he was at the Boston navy yard, and in September 1870 married Miss Anna M. Weld. In 1871 he was made commander and, in charge of the storeship *Relief*, carried food to the famishing people of France. He was in active service until in 1891, when, heart trouble having developed, Captain Perkins returned to his paternal farm in New Hampshire. Here he bought land and purchased and drove race-horses. He lived during the winter in Boston, enjoying reading and companionship until he died in October 1899, of valvular heart trouble.

The prevailing trait of Perkins is *absence of fear combined with adventurousness and pertinacity*. When about 5 years of age he set out to catch a colt in a field. The colt eluded him and crossed a river to another part of the field; the boy stripped, swam across, cornered the colt, fastened the bridle (which while swimming he had carried about his own neck) and, mounting the colt, recrossed the river, dressed, and rode home in triumph. At 6 years he was sent on a necessary errand alone in the winter to Concord, New Hampshire, 10 miles away and, tied in the sleigh, made the trip without mishap. At the Naval Academy he constantly broke the rules, entertained friends late at night, boxed on the porch, and got into numberless other scrapes. "Indeed, at times, he seemed almost reckless and daredevilish." So in war, he was always first in danger and enjoyed it. Of his walk to the city hall of New Orleans surrounded by a mob, George W. Cable, an eye-witness, says: "It was one of the bravest deeds I ever saw done." In the early hours of the battle of Mobile Bay, Perkins was seen on top of the turret waving his hat and dancing about with delight and excitement. When the gunners in the turret, struck with fear by the rapid sinking of the mined sister-monitor *Tecumseh*, were about to rush from the turret, Perkins sprang in front of them and threatened to shoot the first man who left his post, and thus ended the trouble. When Perkins received the order to fight the *Tennessee* the messenger reported: "Happy as Perkins habitually is, I thought he would turn a somersault overboard with joy when I told him." Said Admiral Farragut of him in his report: "No braver man ever trod a ship's deck." He was "as cool as Cushing; had as little anxiety for personal safety as Nelson." Of Captain Perkins's father, Hamilton Eliot Perkins, it is said he was "brave and plucky—a positive man, from whom George must have inherited much of his natural courage." Also, Captain Perkins's mother had a brother, Captain Paul R. George, who was "remarkably efficient."

Perkins was a *hyperkinetic*. His good humor was unflinching, his joviality contagious, his flashing eye commanded attention. He would often say the opposite of what he meant to enjoy the discomfiture or indignation of the reaction, but he was never cruel in his fun. He was versatile and constantly in action, even from boyhood.

Perkins had a great *liking for animals* and pets of all kinds, "a family trait, come from the Georges." For horses he had a veritable passion. He early had a pony of his own and rode with his father through the woods. After he returned to the farm he purchased and drove race-horses; perhaps it was their action as well as beauty of form that appealed to him.

He was *not scholarly*. His teachers counted him dull, since he did not take to books; so he was withdrawn from school and taught at home. At the Naval Academy he was at the bottom of his class and it was only through the intervention of a teacher that he escaped dismissal. He lacked confidence in his mental ability. He once rubbed out an exercise that he had put on the board correctly because, on turning around, he happened to see a classmate laughing. Yet, in later life, he came to appreciate books and enjoyed biography and history. However, he had never scholarship enough to be a strategist but was eminently a fighting captain. He was trustful of others and employed on his farm a man who had been convicted of forgery. He was devoted to his family; "has a quality that can not fail to touch the heart." His father too, was genial, full of kindly humor.

His *love of the sea* developed late. At 8 years of age he moved with his father to Boston, where he saw much of the trading-ships in which his father was interested, but showed no longing to go on them and willingly returned to the country. So in later life he seemed contented as a gentleman farmer.

## FAMILY HISTORY OF GEORGE HAMILTON PERKINS.

I 1 (M F M F), Captain Benjamin Harriman. II 3 (M M F), Benjamin Emery, a captain in the Revolutionary war. III 1 (F F), Roger Eliot Perkins (1769-1825).

IV 1 (F), Hamilton Eliot Perkins, studied at the Harvard Law School and for sixteen years presided over the probate court of Merrimac county; was interested in lumbering. IV 2 (M), Clara Bartlett George. *Fraternity of M*: IV 3, Captain Paul R. George, who was remarkably efficient. IV 4, John H. George, one of the most brilliant lawyers in New Hampshire.

V 1 (*Propositus*), GEORGE HAMILTON PERKINS.

*Child of Propositus*: VI 1, Isabel Perkins. VI 2, Lars Anderson (born in Paris, 1866), after being graduated from Harvard, spent two years in travel around the world. He was a captain and assistant adjutant general, United States volunteers, during the Spanish American war; was appointed ambassador extraordinary and plenipotentiary to Japan in 1912.

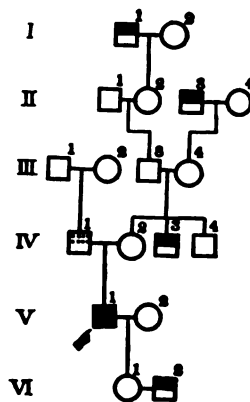

## BIBLIOGRAPHY.

CARROLL, S. George Hamilton Perkins, U. S. N., His Life and Letters. Boston: Houghton Mifflin Co.

## 50. PERRY FAMILY.

\* MATTHEW CALBRAITH PERRY was born at Newport, Rhode Island, 1794. He entered (March 1809) the United States navy as a midshipman at the naval station in New York City. Within a few months he was on board his brother's ship, the *Revenge*, and a little later was made Commodore Rodgers's aid on board the *President*. He took part in the affair of the *Little Belt*, which precipitated the War of 1812. He accompanied Commodore Rodgers on his cruise in the seas of northern Europe. In 1813 he became lieutenant. After the war he made a voyage to Holland on his father's merchantman, but in 1817 reentered the navy. He was connected with the colonization of Liberia. He had many encounters with pirates, and in 1824 he sailed to the Mediterranean as part of the squadron to protect United States commerce from these pirates. In command of the *Brandywine*, he induced the city of Naples to pay the claims of American citizens for ships and cargoes that had been confiscated. During his ten years of shore duty he organized the Brooklyn (New York) naval lyceum; conceived and advocated the use of the ram on war vessels; studied the system of light-houses on the French and English coasts; introduced successfully the dioptic system of illumination; and was superintendent of the school of gun-practice at Sandy Hook. Because of his great activity in modernizing the navy, he is known as the "Father of the Steam Navy." In 1840 he was appointed commodore in command of the Brooklyn navy-yard and the New York naval station. In 1843, as commander of a squadron of 80 guns, he sailed on a mission to suppress piracy and the slave-trade. His services in the Mexican war were most important in gaining control of the Western coast. In 1853 he visited Japan, and the next year secured a treaty whereby Japan was opened up to the civilization of the West. Upon his return he wrote a report that was published in three volumes. He suffered long from a "rheumatic" infection which caused his death in 1858.

Matthew Perry was superior to his brother Oliver in most matters of judgment and administration. He gave attention to detail, had a sense of humor,

carried on a voluminous correspondence, had a liking for the classics, reread the Bible on every long voyage, often read the service on shipboard. He was a fair player on the flute. His hatred of debt bordered on the morbid. He was active, energetic, alert, systematic, expectant, eager, and earnest. He had a tense set of mind. He was stern and austere in appearance, but gentle underneath. He was never afraid of responsibility, had a manly independence, and was very courageous, positive, and self-reliant. He was liked by children, to whom he brought pets from foreign shores and collections of shells. He had a magnetic personality, and though blunt in his manner he was genial socially and a sincere friend.

OLIVER HAZARD PERRY (brother of Matthew) was born at South Kingston, Rhode Island, 1785. He was educated principally in Newport, Rhode Island, and in 1799 received his commission as midshipman. When the navy was reduced in 1801 he was assigned to the frigate *Adams*, and that vessel with two others was sent to the Mediterranean to clear the sea of pirates. When the embargo was laid by Congress in 1807 he was placed in command of a flotilla of gunboats on the Newport, Rhode Island, station until 1810. In 1812 he sought and obtained permission to join the forces on the lakes. There he cleverly defeated the English at the battle of Lake Erie by abandoning his riddled ship for a fresh one. The United States Congress voted him thanks, presented him with a sword, and gave him the rank of captain. He took an important part in the military operations around Detroit during the rest of the war and attained the rank of commodore. He married Elizabeth Mason. While in command of a vessel in the West Indies he died of yellow fever in 1819.

He was tall and graceful. His brow was massive, full, and lofty; his features regular and elegant; his eyes full, dark, and lustrous; his mouth uncommonly handsome; his teeth large, regular, and white. His countenance was cheerful and mild, and he seemed to have an uncommon share of beauty. He had a strong, well-poised mind and good common sense. He was fond of horses and was an excellent rider; he was also an excellent fencer. For the pen he had an extreme aversion, though he was well versed in history and biography. He had a fine taste for music and was a skilled performer on the flute. He wrote a rapid, easy, elegant hand. He was industrious, energetic, prompt to decide, decisive, and discriminating. As a naval officer he was sensitively alive to the appearance of his ship. He had a sweet and gentle disposition, though he was easily aroused by injustice. His temper was violent when aroused, but he was not disturbed by petty irritability. He was enterprising, firm, daringly courageous, and immovable in his decisions. He had the faculty of arousing strong affection for himself in others; he was affectionate, courteous, unsuspecting, generous, strict, and domestic in taste.

Let us now analyze further the Perry traits, especially as seen in Oliver H. and Matthew C. Perry.

*Love of adventure and absence of fear.* — Of Oliver it is said that, as a child, one of his chief characteristics was "an utter disregard of danger. He knew no fear, a quality which was nobly exemplified throughout life." An incident revealing Oliver's confiding and thoroughly courageous disposition is still preserved in the family. When scarcely more than 2 years of age, he was playing one day with an older child in the road in front of his grandfather's house. A horseman was rapidly approaching, when the older boy, seeing the danger, ran out of the way, calling to Oliver to do the same. But the little fellow sat still until the horse was almost upon him, when, as the man drew rein, he looked up and lisped to him,



"Man, you wud'nt wide over me, wud youh." The horseman, who was a friend of the family, dismounted and carried Oliver into the house, where he related the occurrence with great interest and with as much pride as if it had been his own child. He thought the boy's conduct gave token of some very worthy qualities.

At 5 years of age Oliver went to school and, as the school was some distance from his home, he used to take his cousins, who lived on an adjoining farm, to and from their lessons. They had no brother and, although they were older than Oliver, were glad to accept his boyish protection in adventures on the road. No one thought it strange, as he was large for his years and inspired a confidence in his manliness which was amply justified. From his earliest boyhood he seemed to exercise an influence over those who approached him, which was soon converted into affectionate regard by his graceful manners and by a display of quiet firmness and calm self-composure. The distinction that he afterwards acquired excited no astonishment among the friends of his youth; it seemed but the realization of the promise which his early years had inspired.<sup>1</sup>

Oliver was a fearless and well-poised rider of horses, of which he was very fond. At the age of 16 years he commanded the naval schooner *Revenge*. Having succeeded in capturing the American ship *Diana*, whose captain was fraudulently retaining her and had put her under the protection of two British gunboats, Oliver fell in with a large and powerful British ship which demanded the nature of his convoy. This Oliver refused to give and put himself and crew into position to board suddenly the powerful and menacing ship if she attempted force. The difficulty was amicably adjusted. When, in January 1811 (through the fault of the pilot), his schooner went on the rocks west of Point Judith, he stayed on the schooner, over which the wintry waves dashed, until as the sun set she began to go to pieces; and he was thus able to save most of her valuables. When the War of 1812 broke out Oliver preferred the post of adventure on the Great Lakes to the Newport Station. On Lake Erie he fought one of the bloodiest naval battles in history, considering the number of persons engaged. After all of his guns had been rendered unworkable and four-fifths of his men were dead or severely wounded, he rowed to a fresh vessel. "Unconscious or unmindful of danger, Perry continued to stand erect in the boat, with his brave oarsmen imploring him not to expose himself thus needlessly. For . . . the enemy . . . had at once directed a heavy fire of great guns and musketry at the 'small boat.'" "Yet the unconquerable Perry stood unmoved and defiant." In the fresh vessel he won a decisive victory and complete capture of the British fleet. A few weeks later Perry, on horseback, acting as General Harrison's aide, participated in the defeat of the British land forces. It is said that a British broadside threw the American cavalry into confusion, from which they were rallied by a call from Perry, who dashed in among them. Oliver was at that time 28 years of age.

Matthew Perry showed the same traits of *love of adventure and fearlessness*. At 13 years of age, on hearing of the fight between the *Leopard* and the *Chesapeake*, he desired to go into the navy. Of him at 25 years of age it is said: "A thirst for enterprise and adventure" led Perry to apply for an appointment on the *Cyane*, going to Guinea, Africa." The dangers of the coast lured him." (Griffis, 1890, p. 51.) After his death, Admiral Sands wrote of him: "He was a man of great personal bravery, as well as all the Perrys, of undaunted courage and gallantry." (Griffis, p. 400.)

---

<sup>1</sup> Mills, J. C., 1913, p. 5.

A younger brother, James Alexander Perry (born 1801), was with Oliver on the *Laurence* in the battle of Lake Erie, at the age of 13 years. "Having two musket balls pass through his cap, and his face blackened by powder and smoke, the little fellow was laid low in front of the commander, by the flying hammock, which had been torn from the nettings by a cannon ball. He was only bruised and slightly wounded by small particles and soon resumed his duties." He received a sword of honor from Congress for his conduct. He was drowned while still young, attempting to save a sailor's life.

This adventurousness and fearlessness are found elsewhere in the family. The following incidents indicate the nature of the reactions of their father, Captain Christopher Raymond Perry (Mills, p. 17):

"Capt. C. R. Perry was sent to St. Domingo to aid Toussaint against the rebel Rigaud. On the 9th of February, 1800, while cruising off Cape Tiburon, a number of Rigaud's barges were discovered at anchor under the protection of three forts on the coast. Captain Perry at once stood in, and, after a spirited bombardment of the forts for about 30 minutes, they were silenced with a loss to them of a number of killed and wounded, the *General Greene*, meanwhile, receiving only a few shots in her hull and rigging." But he was prevented from seizing the gun-vessels by the arrival of an unfriendly vessel.

"On approaching Havana harbor convoying a merchant ship, a British line-of-battle ship appeared and fired a shot across the bow of the merchantman. As the warship now sent out a boat to board the merchantman Captain Perry sent a shot between the brig and the boat. The line-of-battle ship at the same time bore down, and her commander hailed Captain Perry to demand in no uncertain tone why his boat had been fired upon. 'To prevent her from boarding the American brig which is under my convoy and protection,' the captain promptly replied. This brought the rejoinder that it was very strange that one of His Majesty's 74-gun ships could not board an American brig. 'If she were a first-rate ship with her 120 guns,' replied Captain Perry in thundering tones, 'she should not do so to the dishonor of my flag.'"

Christopher R. Perry's sister, Elizabeth, married a farmer named Stephen Champlin, a distant cousin, who had served in the Revolution. Their son, Stephen Champlin, ran away to sea at the age of 16, and was in command of the little schooner *Scorpion*, of 2 guns, in the battle of Lake Erie. The first shot in the battle was fired from the British flagship. Perry could hardly restrain his men. The first shot in reply was made by Champlin, who had a long gun, and it is stated that Champlin fired the last shot. The *Scorpion* stood near the *Laurence* and kept up a constant fire. (Mills, pp. 129, 147.) For a little gunboat the *Scorpion* played her part no less well under Champlin's command than the *Laurence* under Perry's.

The mother's side contributed fearlessness, also. Sarah Alexander "believed her own people the bravest in the world." (Griffis, 1890, p. 14.) Of her it is said that she had "a degree of force of mind and energy of character not often found in her own sex and seldom equaled in ours"; and, again, "Mrs. Perry was a woman of strong feelings and eminently courageous temperament." (Mackenzie, N. S., p. 843, pp. 21, 28.) After the battle of Lake Erie an old farmer stoutly maintained that it was Mrs. Perry who had "licked the British." (Griffis, p. 14.)

A sister of Oliver and Matthew, Ann, married Commodore George W. Rodgers, himself a gallant officer and commodore in the navy. Of their sons, Alexander was killed while leading a regiment in the storming of Chapultepec and

George W. entered the navy at the age of 14 years and was killed in 1863, while chief of staff of Dahlgren, who said that he was an officer "of the highest professional capacity and courage."

This trait of fearlessness is widely disseminated among more distant male relatives of the Perrys. Thus General Nathanael Greene, perhaps second only to Washington among colonial generals, was a second cousin to Christopher R. Perry. C. R. Perry's mother's father, Oliver Hazard, was second cousin to General Benedict Arnold. A more remote cousin is Ezek Hopkins, first head of the Colonial navy.

*Pertinacity* is another Perry trait. This was marvelously displayed by Oliver in the battle of Lake Erie. Only 18 out of 101 of the men on board the *Lawrence* were uninjured. A British officer reported of the *Lawrence* that "it would be impossible to place a hand on the broadside, which had been exposed to the enemy's fire, without covering some portion of a wound, either from grape, round, canister, or chain shot." The masts were so much injured that they rolled out in the first severe gale. Yet not till every gun was out of commission did Perry move, and then not to surrender the helpless ship but to retire to another and continue the fight!

Matthew had much of this quality, which he showed in diplomacy with the Japanese. On his first arrival at Uraga, the vice governor called and stated that discussion could be held only at Nagasaki; he was informed that the admiral would not go to Nagasaki. The next day the governor called and was again informed that the admiral would *not* go to Nagasaki. Finally, the Japanese yielded and agreed to receive the letter from the president of the United States. After delivering the letter Perry stated that he would return in a few months for the reply. He did so, and decided that he would receive the reply at the capital city. Repeatedly he was told that that was impossible; he persisted, the Japanese acceded; they met at Yokohama. As point by point was haggled over, "Perry intimidated his readiness to stay in the bay a year or two if necessary." (Griffis, p. 363.) Finally a satisfactory treaty was arranged and signed. "It was Perry's pertinacity that first conquered for himself a fleet (to go to Japan); his thorough-going method of procedure in every detail and his powerful personality and invincible tenacity in dealing with the Japanese that won a quick and permanent success without a drop of blood." (Griffis, p. 374.)

In *temperament* the two Perrys differed slightly. From youth Oliver was the more excitable and liable to occasional outbursts of temper. (Mills, p. 26.) At the age of 13 years he and some fellows were sailing boats and planks on the shallow waters of the Pawcatuck near his home. In a play sea-fight, Oliver's craft happened to be run down by that of his playmate. Whereupon "Oliver's rage became ungovernable, and for a minute or two he was anxious for an actual set-to, to recover the lost advantage of the day." (Mills, p. 13.) After his victory in his ship in Tunis bay in 1816, he struck one of his officers a blow for showing what he (Perry) conceived to be a disrespectful attitude. Over this a duel was eventually held, in which Perry, who was ready to apologize, refused to fire at his opponent. Matthew seemed to have his temper better in hand, but he was regarded as "something of a martinet." Both were very energetic, working hard and keeping tense. Both were insistent on discipline and stood for duty all over.

Oliver was a *man of action*, primarily, and reached his highest achievement in battle. He wrote little, and disliked writing. But he made rapid progress in mathematical astronomy, so that when he left school at 13 years of age his teacher declared "that he was the best young navigator in Rhode Island." (Mills,

p. 10.) After his first trip to Algeria it was noted that he had formed the habit of studious thought and reading for improvement of his mind and he then devoted himself to advanced courses in mathematics and astronomy. Matthew was the greater *student*. At every port he made a study of conditions and people. "On the cruise of the *Brandywine* he directed the studies of the young midshipmen, advised them what books to read, what historical sites to visit, and what was most worth seeing in the famous cities." (Griffis, p. 97.) While stationed at the Brooklyn navy-yard he organized the Lyceum "to promote the diffusion of useful knowledge, to foster a spirit of harmony and a community of interests in the service," etc. Specimens were collected and cared for; books and pictures were gathered. Matthew Perry became recognized as a scientific student and was offered command of the United States exploring expedition to the Antarctic, which he declined and which was eventually led by Charles Wilkes. Meanwhile, he showed such special knowledge of, and interest in, steam naval vessels that he was given command of the first one built for our navy, the *Perry*, 1837, and met with intelligence as well as pertinacity the opposition of seamen to replacing sails by propellers and steam-engines. In the same year he suggested the utilization of the ramming facility of the steam war-vessel. In 1838 Perry's knowledge and scientific interest were utilized in a trip to Europe to look into the matter of an extended system of light-houses, which he had urged, and the new methods that were revolutionizing naval methods. Never was more brilliantly illustrated the value to a nation of the student in the navy than in the case of Matthew C. Perry. He was a good deal of a naturalist also; he brought shells and plants from his distant trips. His report of the Japanese expedition is accompanied by scientific reports on species brought back and examined by naturalists. A son of Oliver and Matthew's sister, Ann Maria, is Christopher Raymond Perry Rodgers, who was in 1874-1878, and again later, superintendent of the Naval Academy, an evidence of scholarship.

Both of the Perrys were *self-reliant*, each in his own way. Early trained to assume responsibility, they did so in emergencies and with such intelligence, courage, and pertinacity that they were invincible. Both were faithful to duty. This involved a certain conservatism, and this was shown in the way in which they cherished throughout life the religious teachings of their mother. "She trained them to the severest virtue, purest motives, faithfulness for sacred things. The habit which Matthew C. Perry had of reading his Bible through during every cruise, his scrupulous regard for the Lord's day, the American Sunday, his taste for literature, and his love for the English classics were formed at his mother's knee." (Griffis, pp. 13, 14.) Oliver was less evidently religious. Yet, as he returned after his victory on the *Niagara* to the decks of the *Lawrence*, he said: "The prayers of my wife have prevailed in saving me"; and in reporting to the secretary of the navy he begins: "It has pleased the Almighty to give to the arms of the United States a signal victory." The emotional side of Oliver was, indeed, well developed; he had a fine taste for music and was a skilled performer on the flute. He was affectionate and aroused strong affection for himself in others. When the British officers surrendered their swords to him at Lake Erie he requested them to retain their sidearms. Later the British commander toasted "Commodore Perry, the gallant and generous enemy." Much of the native culture and grace shown by the Perrys is found in their father's mother's family, the Hazards. Of Mercy Hazard's father, Oliver Hazard, it is said, "he had elegant manners and cultivated tastes."

## PERRY FAMILY.

*Fraternity of F M F M F F F*: I 3, Joanna Arnold. I 4, William Hopkins (from whom is descended Ezek Hopkins, No. 27).

II 1 (F M F M F F F), Benedict Arnold (1615-1678), president of the Providence Plantations and colonial governor of Rhode Island. II 2 (F M F M F M), Damaris Westcott.

III 1 (F M F M F), Caleb Arnold (born 1644). *Fraternity of F M F M F*: III 3, Benedict Arnold. III 4, Mary. III 5 (M M F F F), James Wallace, Lord of Dundonald, was a colonel of the British army until he signed the Solemn League and Covenant of 1643 and was forced to flee to Holland, where he died in 1678. He was in direct descent from Sir Richard Wallace, own paternal uncle of William Wallace, the great Scotch patriot. III 7, Ann Borodel, of Irish ancestry. III 8, George Denison, born about 1618, a brilliant Indian fighter (see George Dewey, F F F M M F).

IV 1 (F F F F), Edward Perry (born in England, 1630), came to New England, where he showed himself "an unusually militant Broadbrim and retaliated upon his persecutors by writing a railing accusation against the court of Plymouth." IV 2 (F F F M), Mary Freeman. IV 3, (F M F F), George Hazard, a large land-owner who was a lieutenant colonel of the militia. IV 4 (F M F M), Penelope Arnold. IV 5, Captain Benedict Arnold. IV 6, Hannah King. IV 7 (M M F F), James Wallace, settled in Ireland. IV 9, George Denison (1653-1711).

*Fraternity of F F F*: V 1, Rest Perry. V 2, Jacob Mott. V 3 (F F F), Benjamin Perry (1677-1742), removed to Rhode Island. V 4 (F F M), Susannah Barber. V 5 (F M F), Oliver Hazard, a man of property. V 6 (F M M), Elizabeth Raymond. V 7, Benedict Arnold (1741-1801), a general in the Continental army and a traitor. V 8 (M M F), James Wallace. V 10, Samuel Denison (born 1686).

VI 1, Mary Mott. VI 2, Nathanael Greene, a Quaker preacher. VI 3 (F F), Freeman Perry (1733-1813), a physician who owned surveying instruments. He was chief justice of the court of common pleas and president of the town council of Kingston. VI 4 (F M), Mercy Hazard (1740-1810). VI 5 (M F), — Alexander, of Ireland. VI 6 (M M), — Wallace. *Fraternity of M M*: VI 7, William Wallace. VI 9, Thomas Reynolds, a Presbyterian minister of Delaware. VI 11, Gideon Denison (born 1724). VI 12, Elizabeth —. VI 13, Benjamin Butler (1739-1787), a blacksmith of Norwich, a witty and original man who was very eccentric. In 1776 he was imprisoned on charge of "defaming the Honorable Continental Congress." VI 14, Diadema Hyde.

VII 1, Nathanael Greene (1742-1786), a brilliant general of the Continental army, who had command of the southern army during the Revolution. *Fraternity of F*: VII 2, Joshua Perry (1756-1802), a surgeon in Colonel Church's battalion. VII 3, Oliver Hazard Perry, lost at sea in about 1873. VII 4, Elizabeth Perry (1762-1811). VII 5, Stephen Champlin, a farmer, a double distant cousin. VII 6, Mary and Susan Perry. VII 7, George Hazard Perry. VII 8, Christopher Raymond Perry (1761-1818), a sea captain who served with distinction upon armed vessels during the Revolutionary war; in 1798 he became a captain in the United States navy. Later he became collector of internal revenue at Newport and Bristol. VII 9 (M), Sarah Alexander Wallace, born in Ireland, 1768. VII 10, William Bailey Wallace, an attorney of the King's Bench, Dublin. VII 11, Robert Wallace. VII 12, James Wallace, served under Cornwallis in India, where he died, 1794. VII 13, Alexander Wallace, served in the army under Cornwallis, and also commanded a merchantman. VII 14, Charles Wallace, was a surgeon in the British army and was on board the *Invincible* when Howe defeated the French in 1795. VII 15, John Rodgers, born in Scotland, 1726, settled in Maryland about 1750. He was a captain of a regiment of militia during the Revolution. VII 16, Eliza Reynolds (born in Delaware in 1742 or 1743), was a woman of great strength of character. VII 17, Gideon Denison (born 1753), was a merchant of Norwich, Connecticut, who removed to Maryland where he engaged in land speculation. VII 18, Jerusha Butler (born 1762), an active and energetic woman. VII 19, Thomas Butler (born 1769), was educated at Yale College. VII 20, Benjamin Butler (born 1764), practiced medicine for a time, then became a merchant, and later a shipping merchant. Afterwards he went to New York, where he engaged in brokerage, but finally settled in Oxford, New York.

VIII 2, Stephen Champlin (1789-1870), rose to the rank of commodore in the United States navy. *Fraternity of Propositus*: VIII 3, OLIVER HAZARD PERRY (see text). VIII 4, Elizabeth Mason. VIII 5, Jane Perry (1799-1875). VIII 6, William Butler (1790-1850), a surgeon in the United States navy, and agent to the Cherokee Indians. From this marriage came the Butlers of South Carolina, who were noted for their military ability. VIII 7, Raymond Henry Jones Perry (1789-1826), a captain in the United States navy. VIII 8, James Alex-

ander Perry (born 1801), a naval officer. VIII 9, Nathanael Hazard Perry (born 1802), became a midshipman in the United States navy and later a purser. VIII 10, Sarah Wallace Perry, a bit eccentric. VIII 11, Ann Marie Perry (1797-1856). VIII 12, George Washington Rodgers (1787-1832), entered the navy in 1804 and was on board the *Wasp* when she engaged the *Frolic*. For gallantry in the War of 1812 he received a medal from Congress and a sword from Maryland. VIII 13, Maria Ann Rodgers. VIII 14, William Pinkney (1764-1822), a statesman, senator, and diplomat of considerable note, independent and eloquent. His brother Ninian was a soldier, traveler, and author. VIII 15, Rebecca Rodgers. VIII 16, Andrew Gray. VIII 17, Alexander Rodgers. VIII 18, Thomas Reynolds Rodgers, a physician. VIII 19, Mary Rodgers. VIII 20, Howes Goldsborough. VIII 21, Elizabeth Rodgers. VIII 22, JOHN RODGERS (1733-1832), rear admiral (see No. 56). VIII 23, Minerva Denison (1784-1877), musical. VIII 24 (*Propositus*), MATTHEW CALBRAITH PERRY. VIII 25, (consort) Jane Slidell (born 1797), sister to VIII 28, a very beautiful woman. *Fraternity of consort*: VIII 26, John Slidell (1793-1871), a statesman who was captured during the Civil War with his compatriot, Mason, on the *Trent*. VIII 27, Alexander Slidell Mackenzie (1803-1848), assumed the surname of his maternal uncle. At the age of 12 years he entered the navy and rose to the rank of commander. He had considerable literary ability and wrote several naval biographies. VIII 28, Julia Slidell, sister to VIII 25, married C. R. Perry (see also IX 9).

IX 2, Oliver Hazard Perry (born 1815), a lieutenant in the United States navy, who resigned in 1848. IX 3, Christopher Raymond Perry (born 1816), was graduated from the United States Military Academy, West Point. IX 4, Christopher Grant Perry (born 1812), a physician. IX 5, Frances Sergeant. IX 6, Elizabeth Perry (1819-1842). IX 7, Rev. Francis Vinton. IX 8, Christopher Raymond Perry Rodgers (1819-1892), became a midshipman in 1833, distinguished himself during the Civil War, and in 1874 was commissioned a rear admiral. IX 9, Julia Slidell (VIII 28). IX 10, John Rodgers, a captain in the United States navy. IX 11, George Washington Rodgers (1822-1863), a naval commander during the Civil War. IX 12, Alexander Perry Rodgers, who was killed at Chepultepec. IX 13, Sarah Rodgers (1831-1901). IX 14, Charles Pinkney (1797-1835), a diplomatist and journalist. IX 15, Edward Coate Pinkney (1802-1828), entered the navy when 14 years of age but resigned because of a quarrel with his superior officer; went to Mexico intending to join the navy, but killed a native and had to flee from the country. He wrote a number of exquisite poems. IX 16, Frederick Pinkney, journalist, poet, and attorney. IX 18, John Rodgers (1812-1882), a rear admiral. IX 19, Ann Elizabeth Hodge. IX 20, Frederick Rodgers. IX 21, Henry Rodgers, a lieutenant in the United States navy. IX 22, Augustus Frederick Rodgers, head of Coast and Geodetic Survey, was in the naval service. IX 23, John H. Rodgers. IX 24, William Pinkney Rodgers, a lawyer. IX 25, Ann Minerva Rodgers. IX 26, Col. John Navarre Macomb. IX 27, Jerusha and Elizabeth Rodgers. IX 28, Louisa Rodgers. IX 29, Montgomery Meigs (1816-1892), upon being graduated from the United States Military Academy, West Point, was commissioned a lieutenant in the Engineer Corps. During the Civil War he was quartermaster general. Later he became an engineer and architect. IX 30, Colonel Robert S. Rodgers. *Children of Propositus*: IX 31, Sarah Perry. IX 32, Oliver Hazard Perry, a lieutenant in the United States Marines, became consul to Hong Kong. IX 33, Jane Hazard Perry. IX 34, John Hone. IX 35, John and William Perry. IX 36, Anna and Susan Perry. IX 37, Matthew Calbraith Perry, became a midshipman in the United States navy in 1835, and rose to the rank of captain, retiring in 1867. IX 38, Harriet Taylor. IX 39, Caroline Slidell Perry. IX 40, August Belmont (born 1816), a well-known banker. IX 41, Isabella Perry. IX 42, George Tiffany.

X 1, Thomas Sergeant Perry (born 1841), sometime editor of the *North American Review*. X 2, Lilla Cabot, an artist and author. X 3, Oliver Hazard Perry (1842-1913). X 4, Frances Sergeant Perry. X 5, Dr. William Pepper. X 6, John F. Rodgers, a captain in the United States army. X 7, Thomas Slidell Rodgers, a lieutenant in the United States navy. X 8, Raymond Perry, was executive officer on the *Iowa* throughout the Spanish American war and was advanced five numbers in rank for "eminent and conspicuous conduct" in the battle off Santiago; holds the rank of rear admiral. X 9, William Ledyard Rodgers, a commander of the United States navy. X 10, Fredericka and Helen Rodgers. X 11, Montgomery Meigs Macomb (born 1852), was graduated fourth in his class from the United States Military Academy, and served during the Spanish American war, being created a brigadier general in 1910. X 12, Augustus C. Macomb, a major in the United States army. X 13, Charles and Vincent Meigs. X 14, John Rodgers Meigs (born 1842), was graduated at the head of his class from the United States Military Academy and was killed in 1864, having been advanced to captain and major for gallantry. X 15, Mary Meigs (born 1843). X 16, Colonel Joseph Taylor, United States army.

X 17, Montgomery Meigs (born 1847), an engineer of note. X 18, Louisa Meigs (born 1854). X 19, Archibald Forbes, a noted English war correspondent. *Children's children of Propositus*: X 20, Frederick Rodgers (born 1842), was appointed to the United States Naval Academy in 1857 and served with the blockading squadron during the Civil War. He had command of the *Puritan* during the Spanish-American war and was promoted rear admiral 1899. X 21, John Augustus Rodgers (born 1848), was appointed to the United States Naval Academy in 1863 and saw active service during the Civil War. In 1897-1898, as executive officer of the *Indiana*, he took part in the destruction of Cervera's fleet and was advanced five numbers in rank for "eminent and conspicuous service," being made rear admiral in 1898. X 23, Jane Rodgers. X 24, John F. Meigs. X 25, Perry Belmont (born 1851), member of Congress, envoy extraordinary and minister plenipotentiary to Spain; a major inspector general in the United States Volunteers; a capitalist of New York City. X 26, August Belmont (born 1853), a capitalist and financier. X 27, Oliver Hazard Perry Belmont (1858-1908), was educated at the United States Naval Academy and served in the navy two years; later a banker and politician. X 28, Frederick Belmont, born 1854. X 29, Samuel Howland. X 30, Raymond Belmont (1866-1887). X 31, Jane Perry Belmont (1856-1875).

XI 1, John Taylor, a captain, United States army. XI 2, Montgomery Meigs Taylor, a lieutenant, United States navy. *Children's children of Propositus*: XI 3, John Rodgers, a lieutenant, United States navy.

## BIBLIOGRAPHY.

- BALDWIN, J., & W. CLIFT. 1881. A Record of the Descendants of Captain George Denison of Stonington, Connecticut. Worcester: Tyler & Seagrave. 5 + 423 pp.
- DEAN, J., H. DROWNE, and E. HUBBARD. 1879. Genealogy of the Family of Arnold in Europe and America with Brief Notices. (In: New England Historical and Genealogical Register for Oct. 1879.)
- GRIFFIS, W. 1880. Matthew Calbraith Perry. Boston: Houghton Mifflin & Co. xvi + 459 pp.
- HALL, A. 1909. Biographical Memoir of John Rodgers. (Nat. Acad. of Sci. Biogr. memoirs) Washington. Vol. 6, pp. 81-92.
- HAZARD, C. 1895. The Hazard Family of Rhode Island. Boston: Hazard. vi + 293 pp.
- LYMAN, O. 1905. Commodore Oliver Hazard Perry. New York: Harper & Bros. 2 vols.
- MILLS, J. 1913. Oliver Hazard Perry and the battle of Lake Erie. Detroit: J. Phelps. 6 + 278 pp.
- NILES, J. 1821. The Life of Oliver Hazard Perry. Hartford. O. Cooke. xii + 14-384 pp.
- PAULLIN, C. 1910. Commodore John Rodgers. Cleveland: A. Clarke & Co. 434 pp.
- PERKINS, M. 1895. Old Houses of the Ancient Town of Norwich. Norwich: Press of the Bulletin Co. 621 pp.
- PERRY, C. 1913. The Perrys of Rhode Island. New York. T. Wright. 7-115 pp.
- RICHARDS, G. 1833. Memoir of Alexander Maccomb. New York: McElrath, Bangs & Co. x, 11-130 pp.

**PERRY.**

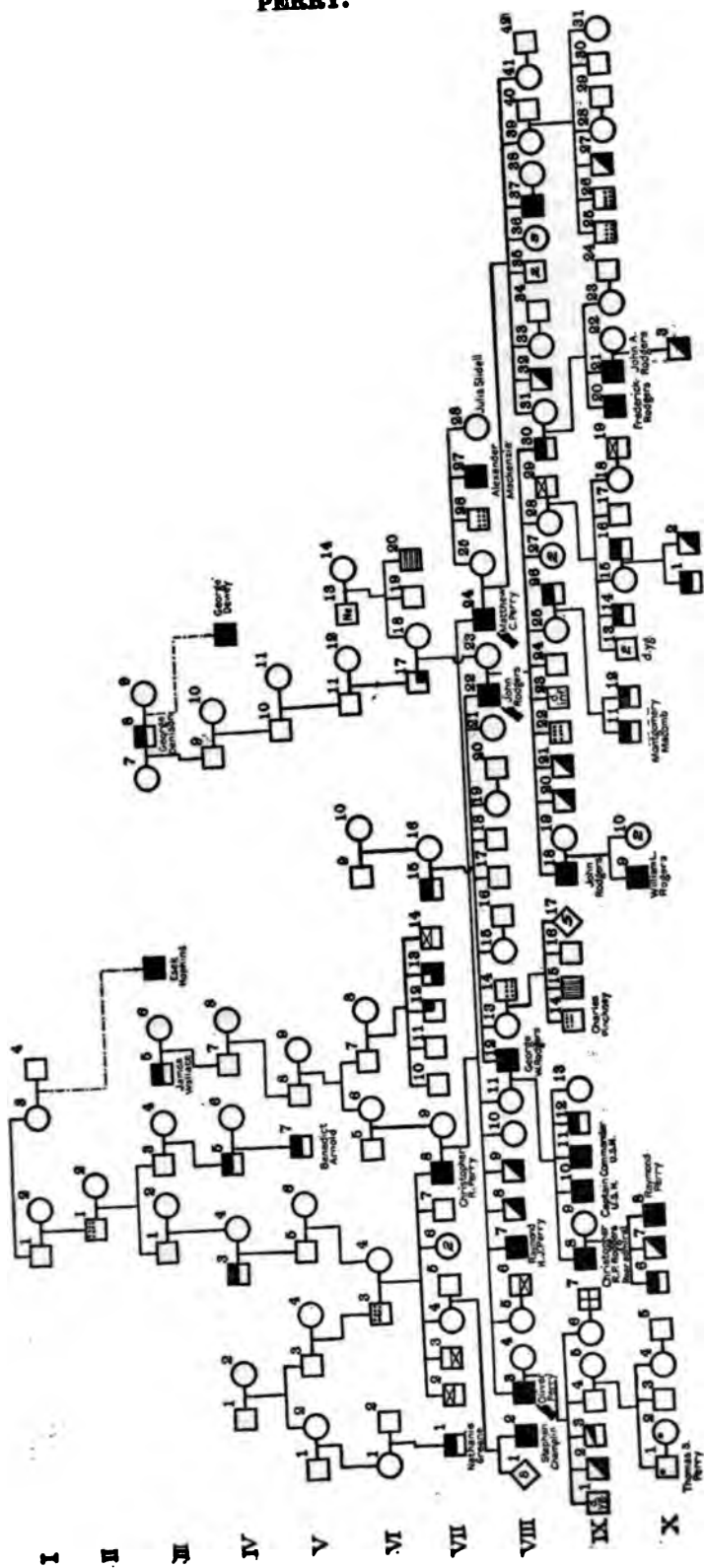



## 51. JOHN WOODWARD PHILIP.

JOHN WOODWARD PHILIP was born at Kinderhook, Columbia county, New York, August 26, 1840. He entered the Naval Academy September 1856, and in July 1862 was commissioned lieutenant. Until 1865 he was executive officer of the *Chippewa*, *Pawnee*, and *Montauk* in succession, blockading the South Atlantic seaboard. After the war he was executive officer of various flagships. For two years he commanded a Pacific mail steamer; in April 1877 he commanded the Woodruff scientific expedition around the world, and for several years was assigned to survey work on the coast of Mexico and Central America. He was given various commands, was inspector of the cruiser *New York* while building, was for three years commandant of the Boston navy-yard, and in October 1897 was given command of the battleship *Texas*. At the outbreak of the Spanish-American war the *Texas* went with Commodore Schley's squadron to the south coast of Cuba. In May 1898 they lay off the entrance of Santiago harbor, and on July 3, when Cervera's fleet essayed to escape from the harbor, the 12-inch shells of the *Texas* did remarkable execution and the *Texas* was herself little damaged. At the close of the war Philip was made commodore and placed in command of the North Atlantic squadron. He was commandant of the Brooklyn navy-yard from 1899 until his death the next year.

Philip was prevailingly of the *nervous type* of temperament, with little tendency to repress his emotions. "As a boy he was full of pranks; was in all the devilry in a mild form which his mates indulged in — chalking the teacher's rush-bottomed chair, freezing up the academy bell so that it couldn't be rung, shooting beans from the back of a large hall at the time of an 'exhibition' of compositions and recitals at the Academy. With a deep-seated belief in democracy, he caught a long-haired son of a rich family and filled his hair with burrs, so that the hair had to be cut off. While still in his kilts he would fight his brother at family prayers. At the Academy he led a hazing party that tarred and feathered an unpopular midshipman. His humor was irrepressible. At the Naval Academy he would get his section laughing while he sat stolid; he received demerits almost daily for loud laughing in the mess-hall. Indeed, in his course, he received more than the maximum of demerit marks, mostly for loud laughing, smoking a pipe, or endeavoring to cover the shortcomings of others."

His *initiative* was shown when at 8 years of age his father sent him to drive a horse and carriage to an adjoining town. When but a short distance from home a wheel of the carriage broke down. Instead of returning home he unhitched the horse, got on his back, went on to a smithy, ordered the wheel repaired, rode on to fulfil his errand and on returning picked up the repaired vehicle. As a young lieutenant, left in charge of the ship off Havana harbor, which the captain thought wise not to try to enter because of adverse winds, he brought the ship into the harbor. As an executive officer he was remarkably successful in obtaining favor and respect of his commanding officers.

He was honorable. Even as a boy he paid for the pane of glass in a neighbor's house which he accidentally broke with a stone. He resented having his word doubted.

He early had a *nomadic* tendency. As a boy he wrote on the flyleaf of a book: 'Would I were a missionary.'

He was *quick in response* in an emergency. In the battle off Santiago the *Texas* was chasing the Spanish ships when the *Brooklyn* emerged out of the smoke right ahead. He instantly ordered "full speed astern," which prevented the collision.

He was *full of sympathy*, as when in the battle the *Vizcaya* of Cervera's fleet blew up on the beach and the men on the *Texas* started to cheer, Captain Philip held out his hand and said: "Don't cheer, men; those poor fellows are dying!" His emotional output is illustrated by the incident that when the battle was over he called all hands aft and invited those who felt so inclined to stand bareheaded and offer silent thanks to God. At the Brooklyn navy-yard Philip was interested in developing the Young Men's Christian Association.

Of relatives of Philip we have secured little information. One of his sons entered the naval service. His father, John Henry Philip, received instruction at the Troy Polytechnic Institute and after studying medicine at Vermont Medical College practiced medicine in Columbia county. A great-grandfather, George Philip, was a captain in the American army during the Revolution and served as commissary of subsistence. The mother's father was Dr. Theodore Woodward, professor of surgery at Vermont Medical College.

FAMILY HISTORY OF JOHN WOODWARD PHILIP.

I 1 (F F F), George Philip (died 1806, aged 54), was a captain in the American army during the Revolutionary war and served as commissary of subsistence. I 2 (F F M), Jane Ostrander.

II 1 (F F), John G. Philip (1783-1834). II 3 (M F), Theodore Woodward, was one of the founders as well as professor of surgery at the Castleton Medical College, Castleton, Vermont.

III 1 (F), John Henry Philip (born 1811), practiced medicine. III 2 (M), — Woodward.

IV 1 (*Propositus*), JOHN W. PHILIP.

Children of *Propositus*: V 1, Woodrow Philip, a midshipman in the navy. V 2, Barrett Philip.

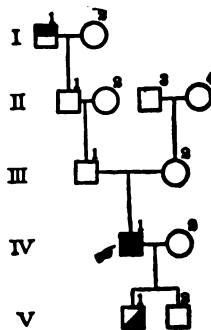

BIBLIOGRAPHY.

MACLAY, E. S. 1903. *Life and Adventures of Jack Philip*. New York: Illustrated Navy. 290 pp.

## 52. ARTHUR PHILLIP.

ARTHUR PHILLIP was born in London, October 11, 1738. At 13 years of age he was sent to Greenwich school; at 17 he was bound to the ship *Fortune*, serving under Captain Everet; and at 23 was a lieutenant. In 1763 he married and settled down as a country gentleman and farmer. When Portugal, in 1775, went to war with Spain, he offered his services and organized the Portuguese fleet, but resigned in 1778, after having given services that were highly appreciated. In 1787 he was commissioned captain general and governor in chief of New South Wales and took 600 male and 180 female convicts to Botany Bay. As governor he displayed energy and wisdom, 1788-1792. In 1814, shortly before his death, he was made admiral.

Phillip was an *organiser and administrator*. He invariably knew how to go about the work in hand and had confidence in his ability to complete it. In starting on his voyage which led to the foundation of Australia, he suggested that a ship be sent to the Friendly Islands to bring the breadfruit plant and women to Australia. He strongly recommended marriage among the convicts, of whom he took both sexes. Later he urged free immigration, saying: "I would not wish convicts to lay the foundations of an empire."

He made *few personal friendships*, and would shrink from, if not abhor, talking or writing about himself, even to his relatives. During his long exile in Australia he never alluded to his family, with whom he could communicate only at long intervals. He left no children. Little is known about his family. His father was born in Frankfurt, Germany, and taught languages in England.

## BIBLIOGRAPHY.

- BECKER, L., and W. JEFFREY. 1899. *Admiral Phillip*. New York: Longmans, Green & Co. xxx + 336 pp.

## 53. PORTER FAMILY.

DAVID DIXON PORTER was born at Chester, Pennsylvania, in 1813. He served with his father (David 2d) when 11 years old in a cruise against the West Indian pirates. At the age of 13 he received a midshipman's commission from Mexico and served with credit under his father throughout her war with Spain. Having been captured by a Spanish frigate, the lad was taken to Havana, guarded for a time, and then released. In February 1829 he was commissioned a midshipman in the United States navy. For 12 years he was on the Mediterranean and the United States Coast Survey. The Mexican war gave Lieutenant Porter a better opportunity to show his valor. As captain of the *Spitfire* he took part in the actions at Vera Cruz and Tuxpan. After the war he commanded mail steamers plying between New York and Panama. He once entered Havana harbor against the prohibition of the Spanish government and defied the guns of Morro Castle, which were not fired upon him. On the breaking out of the Civil War, Porter was assigned to the command of the *Powhatan* and ordered to secure Fort Pickens, Pensacola, to the Union, and this he did. While blockading the mouth of the Mississippi river, the idea of capturing New Orleans came to him and, after it had been accepted by the Navy department, he cooperated with Farragut in carrying it out, and ran by Fort Jackson and Fort St. Philip, which defended New Orleans on the river. Later, Porter bombarded the Vicksburg forts from the river while Farragut passed them. In September 1862 he was made acting rear admiral and given command of the Mississippi squadron, which aided in an important way the fall of Vicksburg. Toward the end of 1864 he captured Fort Fisher the main one of the defenses of Wilmington, North Carolina, after the general commanding the land forces had concluded it was impregnable. After the war Porter was made vice admiral and succeeded to the rank of admiral on Farragut's death in 1870. From 1865 to 1869 he was superintendent of the United States Naval Academy. He wrote a life of his father, the "History of the Navy in the War of the Rebellion" (1887), two novels, anecdotes of the war, and numerous essays; he greatly prized his novels. He died at Washington, February 13, 1891. He married, in 1839, Georgia Ann, daughter of Commodore Daniel Tod Patterson, who commanded the naval forces cooperating with General Jackson at the battle of New Orleans, and sister of Captain Carlisle P. Patterson, superintendent of the United States Coast Survey (1874-1881). They had 4 sons: Major Essex Porter, United States army, retired; Captain Carlisle P. Porter, of the United States marine corps; Lieutenant Theodoric Porter, born in 1849, graduate of the United States Naval Academy, United States navy; and Richard Porter. They had also 2 daughters, the elder the wife of Captain Leavitt C. Logan, United States army, and the younger the wife of Charles H. Campbell.

Some of the Porter traits which were responsible for his achievements were:

*Nomadism.* — As a child, contact with naval men who visited his father roused a desire to go to sea, and he was at sea most of his life from the age of 10 years.

*Love of adventure.* — This alone could lead a boy to court the dangers of naval warfare at the age of 16 years.

*Intrepidity.* — When he challenged Rowan to a duel he was fearless of consequences. His plans to capture the fort at San Juan, to reduce Forts Jackson and St. Philip before Vicksburg, and to capture Fort Fisher, were made with con-

sideration of the requirements of each case but undeterred by the tremendous personal danger involved. As his biographer says, there was "in him an entire absence of bodily fear."

Porter was a marked *hyperkinetic*. He was "self-confident, self-reliant, filled with the courage of his convictions"<sup>1</sup> (p. 48). He had "an irrepressible good humor, a positive exhilaration of spirits, at times an almost boyish jocularity."<sup>2</sup> He had a jesting, easy way of taking the most perilous situations.<sup>3</sup> His was a curious vein of humor, almost sardonic in its character, never malicious, but rising at times to the level of an impish audacity.<sup>4</sup> He had a boyish fondness for skylarking which he never entirely outgrew. Perhaps the most comprehensive term to describe in a word his peculiar temperament is buoyancy. He was never discouraged. No matter how bad the conditions, no matter how much circumstances seemed to make against him, his spirits rose in adversity and carried him lightly over what would have been to other men the most dismal prospects of disaster.<sup>5</sup> He had an impulsive frankness of expression which not infrequently carried him beyond the bounds of prudence. He always had a ready command of expletive which he did not hesitate to use.<sup>6</sup>

"He was, in his youth, full of alertness and dash." There was about him all his life a certain quality, "lawless or dare-devil" — that went far to make the strong personality of the future admiral.<sup>7</sup> Porter's bold plans were conceived by a mind "essentially original, lawless, dare-devil."<sup>8</sup>

"In temperament Porter was restless, eager, energetic. He had the mental make-up of a born fighter, of an officer who finds his true opportunity only in war and in struggle, who before and during the contest had but one idea — to whip the enemy — and who bends all his ingenuity and resource, all his mental and physical force to that end without too much regard to the risk of consequences either to himself, his ship, or his men. He was not only alert and daring in battle, but he had the temperament which makes the battle everything for the moment, and which seems to develop instantly within the man who has all the qualities of mind and heart that the battle demands."<sup>9</sup> "The actual moments of fighting have for him an uncommon zest which showed itself plainly in his high spirits and more intense mental activity."<sup>10</sup>

Like most hyperkinetics, Porter was very attractive to others. All of the officers who served under him showed a personal devotion to him.<sup>11</sup> It is said that, among other things, "his directness of speech, his independence of routine and contempt for red tape, and last, but perhaps not least, his strong vein of boyish humor, which he never took pains to repress — all attracted the President."<sup>12</sup>

His books, which he seemed impelled to write, were not of "any marked importance, for the admiral was not a man of letters but a man of action, and he had no faculty of literary construction or expression."<sup>13</sup>

*Executive ability.* — Porter had not only dash but also self-control enough to plan and carry out details. "But that which distinguished him from others was that . . . he had to an uncommon degree those qualities of independent judgment, boldness, energy, and tenacity combined with a rapid and instinctive stra-

<sup>1</sup> Soley, 1903, p. 48.

<sup>2</sup> *Ibid.*, p. 474.

<sup>3</sup> *Ibid.*, p. 478.

<sup>4</sup> *Ibid.*, p. 476.

<sup>5</sup> *Ibid.*, p. 472.

<sup>6</sup> *Ibid.*, p. 476.

<sup>7</sup> *Ibid.*, p. 40.

<sup>8</sup> *Ibid.*, p. 59.

<sup>9</sup> *Ibid.*, p. 63.

<sup>10</sup> *Ibid.*, p. 475.

<sup>11</sup> *Ibid.*, p. 258.

<sup>12</sup> *Ibid.*, p. 232.

<sup>13</sup> *Ibid.*, p. 463.

tegic perception which mark the greatest of naval commanders. In addition, he had a certain mental habit, rarely found in its full development in such an eager and original nature, but almost equally impressive in ship life, of careful and exact attention to important details of preparation. . . . He was not fussy or overminute, and he was never tied down by any preconceived theories as to the use of a particular instrument or agency where any other would do as well; but he looked narrowly into the conditions that were to confront him and took care to be ready to meet them."<sup>1</sup>

As an organizer he was superior. "His two great objects were celerity and efficiency. He cared very little about methods. He had a perfect sense of logical proportion in the affairs with which he was dealing; and whether large or small, provided they were important, he could give them the attention they deserved. This faculty of taking in the whole of a large field of view at a single glance and at the same time giving minute application to essential details was characteristic of all of Porter's work, whether he was dealing with questions of organization or with the larger problems of strategy in the conduct of actual operations."<sup>2</sup>

The combination of executive ability and hyperkinetic dash was a fortunate one. "It is in these moments of battle that we see Porter at his best, for here we find in its fullest development that extraordinary combination of a cool and even professional judgment, operating with arrow-like swiftness and precision in directing his entire force, with a most intense physical energy and activity."<sup>3</sup>

*Literary impulses.* — These were, as we have seen, strong, though the product was not of high grade and lacked finish. His father wrote two books.

DAVID PORTER (David 2d) was born at Boston, February 1, 1780. At the age of 18 he was appointed midshipman on the frigate *Constellation* and received award for his services when that vessel fought *L'Insurgente*,<sup>4</sup> 1799. He was commissioned lieutenant in 1800, was assigned to the schooner *Experiment*, and fought West Indian pirates. He was active in the naval battles against Tripoli, was captured with the *Philadelphia*<sup>5</sup> and imprisoned in Tripoli until the close of the war (1805). In 1808, as commander, he succeeded his father as sailing-master at the New Orleans naval station. In July 1811 he was assigned to the command of the frigate *Essex*, 32 guns, which, at the outbreak of the War of 1812, set out with orders to pursue British ships. On August 13, the *Essex* captured the *Alert*. Porter decided to take his ship to the Pacific and destroy the British whaling interests there. During the year 1813 he captured numerous British whalers, several of which he equipped for fighting, and added them to his fleet. British frigates having been sent to seize him, he put into the Marquesas Islands for repairs, was led to slaughter the Typee villagers, and then set sail for Valparaiso, arriving there January 1814. Here he was "bottled up" by the British frigate *Phaëte*, 36 guns, accompanied by the sloop-of-war *Cherub* (20 guns). He eventually engaged them both, but the range of the enemy's guns were greater than his own and, as his own ship had lost its maintop in a storm, he could not get near enough to the enemy to inflict damage. When only 75 of his crew of 225 were left effective for duty and his ship was on fire he surrendered to save the lives of the wounded. The survivors returned home in one of the captured whalers, under parole. Off Sandy Hook they were held up by a British frigate, but Porter rowed ashore to Long Island in a whaleboat at night to avoid parleying with the

<sup>1</sup> Soley, 1903, pp. 93, 94.

<sup>2</sup> *Ibid.*, p. 468.

<sup>3</sup> *Ibid.*, p. 471.

<sup>4</sup> *Ibid.*, p. 187.

<sup>5</sup> *Ibid.*, pp. 24, 58, 109, 185.

British captain. For eight years (1815-1823) Porter was on the board of naval commissioners, and then resigned. From 1824 he had charge of a fleet for suppressing piracy in the West Indies. Considering the nation insulted by a certain incident at Porto Rico, he demanded a prompt apology, was found guilty of a breach of international law, and, feeling outraged, resigned his commission. In August 1826 he became commander in chief of the Mexican navy; he served through the Spanish-Mexican war and then returned to the United States. He served in diplomatic posts in the Barbary States and Constantinople, where he died in 1843.

The traits of David Porter which were related to his achievements were:

*Love of sea.* — At an early age the boy displayed the restless energy which ever afterwards characterized him. As he grew in years he developed a fondness for a sea life. His desires were abundantly satisfied in his early career. But serving on the board of navy commissioners was not to his taste. "Captain Porter's restless nature would not permit him to sit quietly in an office, attending to ministerial affairs. Before he had been a year on the board of commissioners he began to weary of the work."

He was *hyperkinetic*. As a boy he indulged in "madcap pranks," for being a boy of ungovernable spirits he was always getting into scrapes which frequently caused him much inconvenience.<sup>1</sup> "As a young naval officer his spirits never flagged; he was impulsive and sometimes too severe, but his impulsiveness was tempered by a generous spirit." His temper was very quick and he would flash up like powder at anything he considered in the least insulting or showing a want of respect towards him. While a midshipman, he was called by an abusive name by the drunken officer of the deck; Porter knocked him down. It was only in trifles that he lost his self-control. Under great provocation he often maintained command of his temper. He was fond of practical jokes.

There was an *artistic element* in David Porter. He made sketches on his cruise on the *Essex* and some of these were published in his account of the cruise. This esthetic appeal showed itself in a fondness for horses<sup>2</sup> that led him to purchase some fine Arabians; also, he was a great admirer of female beauty.<sup>3</sup>

*Obstinacy* is a marked trait. In a desperate encounter on the *Experiment*, in which the captain gave up his ship for lost, Lieutenant Porter took command himself, ignoring his superior, and fought the battle to a successful issue. Off Valparaiso he fought, in the *Essex*, two British vessels, though his maintop had been carried off by a storm. Porter returned their fire "with so great effect as to compel his enemies to retire for repairs; but the *Phæbe*, on returning to the action, opened on him with her long-range guns from a point beyond his carronades. Porter saw that his only hope now lay in the desperate chance of boarding the larger of his adversaries, and with this hope bore down on her with the little sail he could still carry, but the Englishmen kept steadily away, and the *Essex*, hulled at almost every shot, became a helpless wreck, filled with dead and wounded seamen." He planned to run her ashore and blow her up, but adverse winds prevented. "Still he made another effort to board, only to subject himself to repeated raking, then let go his sheet anchor to bring his broadside to bear again, only to part with his hawsers in the effort, and kept up a steady cannonade until his ship was on fire, his boats shot away and but 75 men out of 225 left for effective duty." "His obstinate bravery won the enthusiastic admiration and respect of all his foes."<sup>4</sup>

<sup>1</sup> Porter, 1875, p. 11.

<sup>2</sup> *Ibid.*, p. 408.

<sup>3</sup> *Ibid.*, p. 411.

<sup>4</sup> National Encyclopedia of American Biography, ii, p. 99.

DAVID PORTER senior was bred to the sea. He commanded the sloop *Delight* (6 guns), detailed in 1778 to intercept British supply-ships; later he commanded the *Aurora* (10 guns), with the rank of captain. He was captured and confined in the prison-ship *Jersey*, on which his brother Samuel was confined and died. David made his escape and continued his active cruising to the end of the war. He then commanded a ship in the West India trade. Once in Santo Domingo his ship was boarded by a British press-gang. "Porter armed his men and after a short and sharp struggle drove the intruders from the ship with considerable loss." "His courage and spirit on this occasion were rewarded by an appointment as sailing-master in the reconstructed navy." He spent his declining years at the naval station at New Orleans, of which his son had command. He died in 1808.

In David Porter senior we see the same *love of the sea*, the same quickness in an emergency that are found in his son and grandson. Obstinacy showed in him, also. The love of the sea goes back on the male line to Alexander Porter, father of David, senior, who was a merchant captain and served in the colonial wars.

*Obstinacy and audacity* are seen also in Captain David H. Porter (VI 1), son of David 2d's sister Anne, who married her cousin, Alexander Porter. David H. Porter was a most capable naval officer who accompanied David senior, his uncle, to Mexico and was given command of the *Esmeralda*, in which raider David Porter 2d was placed. The Mexican crew mutinied, but Lieutenant David H. handled the situation well with stern discipline. In a second expedition, when compelled to retire before a superior force, Captain David H. was planning with "the stubborn tenacity which he possessed in common with the rest of his family, an audacity that was little less than sheer recklessness," to give the slip to his pursuer and return for his quarry. But his ship was overtaken and he was killed while in action.

#### FAMILY HISTORY OF DAVID DIXON PORTER.

I 1 (FFF), Alexander Porter (born 1727), was a merchant and a captain who served in the colonial wars.

*Fraternity of FF*: II 1, Samuel Porter, was bred to the sea and sought active service at the outbreak of the Revolutionary war. He was captured and confined on the prison-ship *Jersey*, where he died from his wounds. II 4 (FF), David Porter (died 1808), was bred to the sea; in 1780 he was commissioned a captain in the State navy of Massachusetts (see text). II 6, William Anderson, born Chester county, Pennsylvania, 1763, at the age of 15 joined the Continental army and served 5 years. He held various political offices and in 1809 was elected to Congress, retaining his seat till 1815. III 7, Elizabeth Dixon, of Virginia.

III 1, Alexander Porter. *Fraternity of F*: III 2, Anne Porter. III 4, Mary Porter. III 5, — Brown. III 6, John Porter, entered the United States navy in 1806 and died a commander in 1831. III 8 (F), David Porter (1780-1843) (see text). III 9 (M), Evelina Anderson. *Fraternity of M*: III 10, Thomas Anderson, "something of a fire-eater" (quarrelsome); had a strong sense of humor. III 11 (consort's F), D. J. Patterson, a commodore in the navy.

IV 1, David H. Porter, a lieutenant in the Mexican navy who was killed in action (see text). IV 2, John R. Brown, a diplomat at Constantinople. IV 3, Fitz-John Porter (born 1822), entered the United States Military Academy, and served with distinction through the Mexican and Civil Wars, rising to the rank of general. IV 4, Bolton Porter, a midshipman, was lost at sea. *Fraternity of Propositus*: IV 5, Evelina Porter. IV 6, Captain Harris Heap. IV 7, Imogene Porter. IV 8, — Harris. IV 9, William D. Porter (1810-1865), served throughout his life in the navy. During the Civil War he commanded the *Essex* and distinguished himself in the capture of the *Arkansas*. He died as a result of his injuries. IV 10, Theodoric Porter, was the first officer killed in battle during the Mexican war. He was a lieutenant in the Fourth Infantry and was killed after volunteering to search for another officer. IV 11, Thomas Porter, entered the Mexican navy and died of yellow fever while a midshipman. IV 12, Henry Ogden



Porter, also entered the navy. He was executive officer of the *Hatteras* when she was sunk by the *Alabama*. He died of his wounds in 1869. IV 13, Hambleton Porter, died of yellow fever when a passed midshipman in the home squadron. IV 14 (*Propositus*), DAVID DIXON PORTER. IV 15 (consort) Georgia Ann Patterson. *Fraternity of Consort*: IV 16, Carlile Patterson, entered the navy, but left it to engage in the United States Coast Survey, of which he became head.

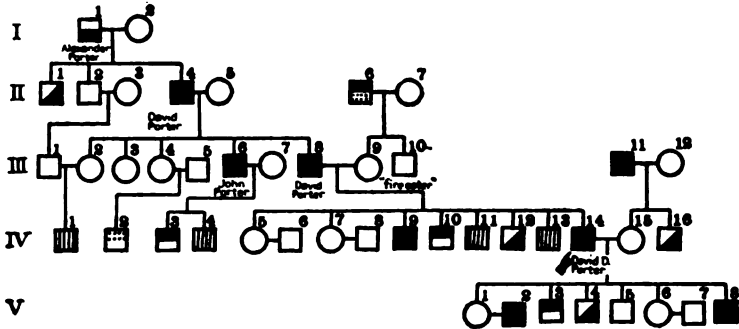

*Children of Propositus*: V 2, Captain L. C. Logan, United States navy. V 3, Essex Porter, a major in the United States army. V 4, C. P. Porter, served in the United States marine corps. V 5, Richard Porter. V 7, Charles H. Campbell. V 8, Theodorick Porter (born 1849), was graduated from the United States Naval Academy in 1869. He rose to the rank of commodore and retired in 1908. He served 43 years in the United States navy, 20 years being spent at sea.

## BIBLIOGRAPHY.

- JOHNSON, W. 1883. *Historical Sketch of Chester, on Delaware*. Chester: Republican Steam Printing House. vi + 336 pp.
- PORTER, D. 1875. *Memoir of Commodore David Porter of the United States Navy*. Albany: J. Munsell. ix + 427 pp.
- SOLEY, J. R. 1903. *Admiral Porter*. New York: D. Appleton & Co. vii + 499 pp.

## 54. EDWARD PREBLE.

EDWARD PREBLE was born at Falmouth, Maine, August 15, 1761. He was blessed from boyhood with a vigorous constitution and was little inclined to sedentary amusements. His leisure hours of youth were devoted to hunting and other active exercise and he was very skillful with a gun. Thus on one occasion he brought down five sparrows singly at successive shots. He was sent to Dummer Academy to be fitted for college, but close study was not adapted to his temperament. He left school and worked for a time on his father's farm, until one day he suddenly threw down his hoe, declaring he would do no more such work, and, trudging afoot to Falmouth, he entered at the age of 16 on board a privateer. Thus he realized a desire he had long expressed — to go to sea. In 1779 his father procured for him a midshipman's warrant in the Massachusetts State marine. He made several cruises in the ship *Protector*, in one of which she was captured by the British and Preble was confined for a time in the prison-ship *Jersey*, but eventually released through the intervention of a friend at New York. As first lieutenant he entered on board the sloop of war *Winthrop*, under Captain George Little, and distinguished himself by capturing, in Penobscot harbor, an armed English brig more powerful than his own vessel. After the war he visited various parts of the world and resided in foreign countries as agent of an American commercial house. In 1798 he was commissioned lieutenant and the following year captain. In 1803 he took command of a squadron of six vessels, of which the *Constitution* was the flagship, and set out to protect American commerce from the attacks of the Barbary States. The Sultan of Morocco readily yielded to the display of force and firmness of Preble, and he next turned to Tripoli and sent the *Philadelphia* and *Vixen* to blockade its coast. In chasing an enemy vessel the *Philadelphia* unfortunately ran aground in the harbor of Tripoli and was seized by the enemy, who took her into the inner harbor and made her officers and men prisoners. Through the intrepidity of Stephen Decatur, jr., who entered the harbor and fired the ship, the capture of the *Philadelphia* was rendered of little avail. The following summer Preble bombarded Tripoli with such destruction of the Tripolitan navy lying there that negotiations for peace were begun; but the terms offered not appearing suitable to Preble, he prepared for a second assault and subsequent attacks were made. Before satisfactory terms were definitely arranged Preble was relieved of his command by Commodore Barron, who arranged the treaty that provided for mutual exchange of prisoners and waived further payment of tribute — the terms originally set by Preble. On returning home Preble was offered the secretaryship of the navy, but failing health led him to decline. He died in 1807.

Edward Preble was a large man, over 6 feet tall, and of striking figure. His manners were polished and courtly and his address pleasant. His naval operations against the Barbary States were comprehensive, direct, and sufficient. "He acted upon the principle that 'the boldest measures are the safest.'" He had an "ungovernable temper, yet had the rare faculty of making and retaining friends." He was a good disciplinarian and no feuds arose among his officers.

Preble married Mary Deering (1770–1851), whose father, Nathaniel Deering (1739–1795), of Kittery, Maine, was a boat-builder and shipped merchandise after the war. They had a son, Edward Deering Preble (1806–1846), who is said to have had a predilection for the sea, but his mother opposed his desires in this

respect. He graduated from Bowdoin College in 1825, indulged in literary pursuits, and traveled much in foreign countries. On his final return home he was frequently a member of the city government, and commanded the Portland rifle corps. Courteous, like his father, he rather shunned society. He married Sophia Wattles, of Alexandria, Virginia. Their son, Edward Ernest, born 1842, entered the United States navy as midshipman 1859; he was navigator of the United States steam sloop *Kearsarge* when she met and defeated the *Alabama*; was lieutenant on the *Susquehanna* at the capture of Fort Fisher; was lieutenant commander 1866, and in 1870 in the Pacific squadron.

Of Edward Preble's sibs there are: (1) Martha, married to Thomas Oxnard, a man who was fonder of study and meditation than of action, but all of whose sons were seamen and two were privateersmen. (2) Ebenezer, a merchant. (3) Joshua, about whom little is known. (4) Enoch, who began his trading voyages at the age of 16 and went to all the countries touching the Atlantic. He held many positions of trust and honor after he abandoned the sea at the age of 61 years. He was prudent, discreet, temperate in habits, and physically strong and healthy. He married Sally Cross and had two sons; the elder, Eben (1802-1845), had a great predilection for the sea, but his father discouraged it. He was a merchant all his life. He also had a natural taste for drawing, especially ships. The younger son was George Henry (1816-1885), who entered the navy, participated actively in the Mexican and Civil wars, and was a man of ripe scholarship, a lover of books, and an author of several historical works. (5) Statira, who married Captain Richard Codman and had two sons who died young. (6) Henry, who (1770-1825) went repeatedly from the United States to Paris and went to Italy intending to open a mercantile house in Tuscany, but abandoned the plan. Subsequently he opened houses in various cities of France. He suffered financial losses and plunged into deep melancholy. He was United States consul at Palermo and first United States commercial agent to Turkey. He visited Algiers, Tunis, Tripoli, and other ports. He had the family taste for drawing and painting. He married Frances Wright and had two daughters, both with artistic talent, and a son, Edward, who died at the age of 20 years of tuberculosis, having planned to be a merchant. The younger daughter, Frances, married Thomas Barlow, secretary to the United States legation to France, and both of their sons were nomadic. Of the elder, Francis Joel Barlow, it is said he had "the Preble roving tendency." He wished to be a surgeon in the navy. He died in Australia, at the age of 26 years. The younger son, Frederick (1830-1864), was a clerk on river boats, entered the United States navy as engineer, and was eventually drowned in the sinking by a torpedo of the monitor *Tecumseh* as she attempted to enter Mobile bay at the van of Farragut's squadron.

The foregoing family history is instructive, inasmuch as the sons of Martha, the sister of Edward and Frances, the daughter of Henry Preble the nomad, are markedly nomadic. The son of Enoch Preble and Sally Cross became, it is true, a rear admiral, but we know little about the mother's family. Edward Preble's son was nomadic, but this son's mother's father was a navigator.

Attention is called to the artistic and literary faculty in the Prebles. Doubtless, the "call of the sea" is often a keen appeal to an artistic sense.

For the origin of the Preble traits we look to the father, Jedediah, sailing-master and brigadier general, who had a violent temper like his son Edward; and to the mother's father, Joshua Bangs, who was a shipmaster. Jedediah

married a second time, Martha Junkins, about whose parents nothing is known, and 3 of their 4 sons were at sea and the other was an Indian interpreter and soldier. A grandson became a religious paranoiac.

## FAMILY HISTORY OF EDWARD PREBLE.

*Fraternity of M F:* I 1, Edward Bangs (1694-1756), was a shipmaster and merchant of much enterprise. I 2 (M F), Joshua Bangs (born Brewster, Massachusetts, 1691), settled in Falmouth, Maine, in 1735, where he was a shipmaster and merchant who held many town offices. I 3 (M M), Mehitable Clarke (1686-1761).

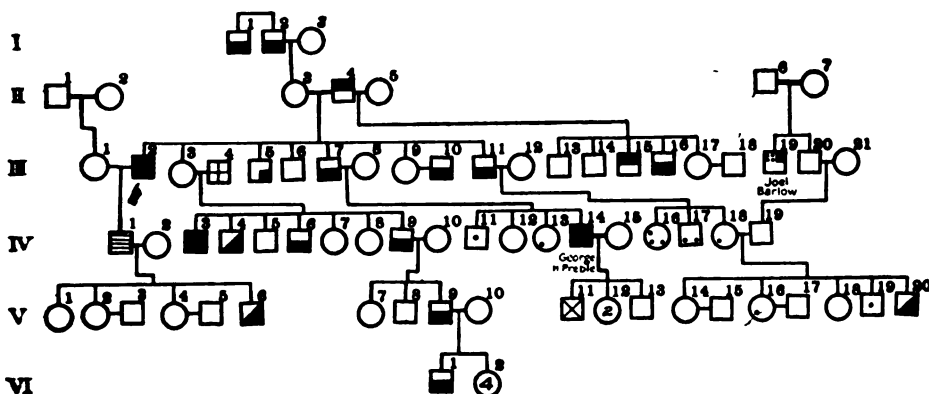

II 1 (consort's F), Nathaniel Deering (born Kittery, Maine in 1739 and died in 1795), was a boat-builder. II 2 (consort's M), Dorcas Milk, of Falmouth, Maine. II 3 (M), Mehitable Bangs, a bustling, energetic woman, "fully alive and attentive to the interests and business of her husband." She died of apoplexy in 1805. II 4 (F), Jedediah Preble (born at York, Maine, 1707), held a captain's commission in 1746, and was commissioned lieutenant colonel of a regiment that took part in the expedition to the eastern frontiers of the province. He accompanied the expedition that removed the French Acadians, and finally held the rank of brigadier general. He is reputed to have been the first to ascend to the summit of Mount Washington. II 5, Martha Junkins. II 6, Samuel Barlow, a farmer.

III 1 (consort), Mary Deering (1770-1851). III 2 (*Propositus*), EDWARD PREBLE. *Fraternity of Propositus:* III 3, Martha Preble (1754-1824). III 4, Thomas Oxnard (born in Boston, 1740), was, until the outbreak of the Revolution, a collector of customs in Maine. In 1787 he officiated as reader of the Episcopal church but eventually he became a Unitarian clergyman (see text). III 5, Ebenezer Preble (1757-1817), was a distinguished merchant of Boston. III 6, Joshua Preble (1759-1803). III 7, Enoch Preble (1763-1842), a shipmaster and office holder. III 8, Sally Cross. III 9, Statira Preble (1767-1796). III 10, Captain Richard Codman. III 11, Henry Preble (1770-1825), made numerous trading voyages. III 12, Frances Wright, married during the French revolution, when a young English girl in a convent school. III 13, Jedediah Preble (1734-1782), died from the effects of a shipwreck. III 14, Samuel Preble, died in the West Indies. III 15, John Preble, (1742-1787), was an Indian interpreter who was lieutenant colonel of the St. John's Expedition of 1777. III 16, William Preble went to sea and was never heard from again. III 17, Lucy Preble, born 1744. III 18, Jonathan Webb, of Boston. III 19, Joel Barlow (1754-1812), served in skirmishes of the Revolutionary war, and became a brigade chaplain. He then took up the study of law and followed literary pursuits, becoming quite renowned as a poet. In 1795 he was consul at Algiers and in 1811 minister plenipotentiary to France.

*Child of Propositus:* IV 1, Edward Deering Preble (1806-1846). IV 2, Sophia Wattles, of Alexandria, Virginia. IV 3, Thomas Oxnard (born 1775), commanded, in the War of 1812, the celebrated privateer, *True Blooded Yankee*, which created havoc in the English Channel. He engaged in mercantile pursuits in France. IV 4, Edward Oxnard (born 1777), was lost in the privateer *Dash*, which foundered at sea in the War of 1812. IV 5, Ebenezer Oxnard (born 1782),

died in Demerara, 1800. IV 6, John Oxnard (born 1785), was lost at sea in 1812. IV 7, Martha Oxnard (1786-1860). IV 8, Mary Oxnard (1787-1796). IV 9, Henry Oxnard (1789-1843), at the age of 15 years became a mariner, and later in the double capacity of master and supercargo made numerous voyages about the world. He finally established himself in Boston, where he became a large ship-owner and builder. IV 10, Charlotte Farnham. IV 11, Eben Preble (1802-1845) (see text). IV 12, Adeline Preble (born 1805), was interested in church work and philanthropy. IV 13, Ellen Bangs Preble (1808-1867), had the family talent for drawing and painting. IV 14, George Henry Preble (1816-1885), served during the Mexican war as executive officer of the *Petrel*. In the Civil War aided in the capture of New Orleans and was in active service throughout most of the war. He was promoted to the rank of rear admiral in 1876. IV 15, Susan Cox. IV 16, Harriet Preble (1795-1854), had considerable linguistic, literary, musical, and artistic talent. IV 17, Edward Henry Preble (1805-1826), a very promising youth with a superabundance of animal spirits, who broke down his health by overstudy. He had considerable musical and artistic talent. IV 18, Frances Amica Preble (born 1797), was of a lively disposition, with a talent for drawing, but she never liked traveling. She enjoyed books of travel and history. IV 19, Thomas Barlow (1784-1859), was adopted by his uncle, Joel Barlow, and was his secretary at Paris.

*Children of child of Propositus:* V 1, Mary Preble (1834-1835). V 2, Mary A. Preble, born 1835. V 3, Edgar Tucker. V 4, Alice Preble, born 1839. V 5, William H. Anderson, a paymaster, United States navy, who later became governor of Maine. V 6, Edward Preble (born 1842), of the United States navy. V 7, Mehitable Oxnard, born 1791. V 8, Enoch Oxnard (1793-1812), was lost at sea. V 9, Stephen Oxnard (born 1795), was captain of a merchantman sailing out of Portland. V 10, Anna Maria Gracie. V 11, Henry Oxnard Preble (born 1847), was captain's clerk on the United States sloop-of-war *St. Louis* during the Civil War. He became assistant professor of chemistry, Massachusetts Institute of Technology. V 13, George Henry Preble, born 1859. V 14, Francis Emma Barlow (1818-1845). V 15, Hugh Wilson. V 16, Amica Barlow (born 1821), had artistic talent. V 17, John D. Chambers. V 18, Harriet Barlow (1824-1827). V 19, Francis Joel Barlow (1828-1854) "dreamed of the navy"; went to Australia. V 20, Frederick Stephen Barlow (1830-1864), an engineer in the navy during the Civil War. He volunteered on the monitor *Tecumseh* and was drowned when she sank in Mobile bay.

VI 1, Stephen Oxnard (1823-1840), was captain of a merchantman.

#### BIBLIOGRAPHY.

- DUDLEY, D. 1896. *History and Genealogy of the Bangs Family in America*. 360 pp.  
 PREBLE, G. H. 1868. *Genealogical Sketch of the First Three Generations of Prebles in America*.  
 Boston: D. Clapp & Son. iv + 336 pp.

## 55. WALTER RALEIGH.

WALTER RALEIGH was born in 1552 in Devonshire, between Exmouth and Sidmouth. He attended Oxford for one year and there showed proficiency in oratory and philosophy. He left Oxford in 1566 for the French wars in a company, led by his cousin Henry Champernown, that was supporting the Huguenot cause, and he remained there 5 or 6 years. He was almost certainly in Paris at the time of the massacre on St. Bartholomew's eve in 1572. In 1578, as captain of the *Falcon*, he accompanied his half-brother, Sir Humphrey Gilbert, on an expedition to find the northwest passage, but this failed because of internal dissensions. Impoverished, he sought to rehabilitate his fortunes at the court and attached himself to the queen's favorite. He also entered the Irish service, advocated a ruthless policy, and recommended assassination as a means of getting rid of the Irish leaders. Returning to England, he became a favorite and lover of Queen Elizabeth. He now put into operation a plan he had long cherished — that of colonizing the American continent from crowded London. Accordingly, Sir Humphrey Gilbert was sent with a colony to St. John's, Newfoundland, in 1583. In the following year Raleigh ordered two captains, Armadas and Barlowe, to explore the east coast of North America, and in 1585, he sent out his first colony, which settled for a time on Roanoke island and on their return brought with them the tobacco plant. Colonies were sent out in the two following years, but they also failed. In 1588 he was serving as vice admiral in looking after the coast defenses of Devon. In 1592 he was at sea with a fleet to intercept the Spanish trade. In 1595 he undertook a voyage of exploration, gold-hunting, and conquest to South America, and wrote his book "Discoverie of Guiana." In 1596 he took part in the capture of Cadiz, and in 1597 he cooperated in an expedition to the Azores. With the death of the Queen, Raleigh's fortunes fell and he was deprived of many sources of income. In revenge he took part in some conspiracies directed against James I and was imprisoned. In confinement he made chemical experiments, wrote treatises, and began his "History of the World." Promising to bring gold from Guiana, he was released to direct the expedition. But all he accomplished was to lose his son, his favorite captain, and his prestige; and the old sentence of death was executed in October 1618.

Raleigh had a *craving for adventure*. He could not long remain on land in comparative inactivity. In Ireland he, with 6 men, rode through an ambush, of whose presence he was aware, to meet a friendly leader on the other side. He was fond of fighting. As we have seen, he left Oxford to take part in the French wars and was actively engaged in Ireland and at Cadiz. He was twice arrested for dueling. This adventurous and nomadic trait is seen in his mother's brothers and his half-brother, Sir Humphrey Gilbert.

Raleigh was a *hyperkinetic*. He had restless energy and much initiative. He protested violently against the mismanagement of the Irish war. He trusted his own opinion and did everything with all his might. He had imagination and vision. He early urged that the surplus from England should be transplanted to the new continent; this was partly also to secure these lands for England. Like many another hyperkinetic, he had weak control over his sex-impulses. He carried out even bizarre ideas that occurred to him. Thus he plastered the mouth and beard of a great talker with sealing wax. Having made prisoner an Irishman who carried withes and who, answering a demand, declared with spirit they were

to hang English churls with, he bade his men hang the prisoner to the nearest tree, saying "they shall serve for an Irish kerne." Raleigh had numerous ideas, many of which were wise. His orders for discipline and sanitation on shipboard were eminently fitting and in advance of his time. He expressed his ideas readily, as his poetry, his treatises, and his history prove. He was throughout a lover of knowledge and found interrogation of nature a solace in captivity.

FAMILY HISTORY OF SIR WALTER RALEIGH.

I 1 (M M M F), Sir William Huddesfield. I 2 (M M M M), Elisabeth Bosome.  
 II 1 (M M F), Sir Edmund Carew, a great soldier who fought at Bosworth Field. II 2, (M M M), Katherine Huddesfield.  
*Fraternity of M M*: III 1, Sir William Carew. III 3, George Carew, D. D. III 4, Anne Harvey. III 5, Sir Henry Norreys. III 7, (M M), Katherine Carew. III 8 (M F), Sir Phillip Champernoun, of Modbury. III 9, (F's consort's F) Giacomo de Ponte, a merchant of Genoa. III 11 (F's consort's F), John Drake, of Exmouth.

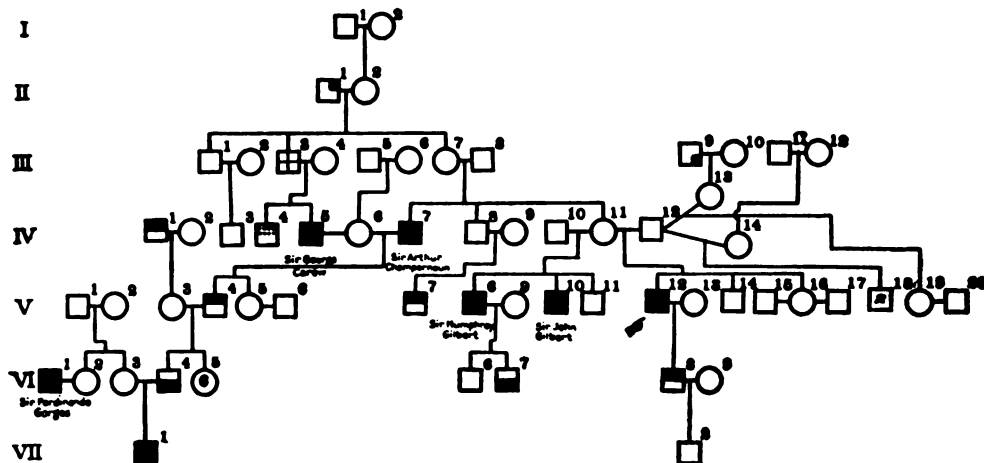

IV 1, Count de Montgomery, leader of the Huguenot cause. IV 3, Sir Peter Carew. IV 4, Sir Peter Carew, connected with the western conspiracy against Queen Mary of England. IV 5, Sir George Carew, Earl of Totnes, a noted and accomplished naval commander, who perished in the celebrated *Mary Rose*, sunk off Portsmouth, 1545. IV 6, Mary Norreys. IV 7, Sir Arthur Champernoun, was involved in the conspiracy against Queen Mary and was sent to the tower. Later he was vice admiral of the west and was associated with his nephew Sir Humphrey Gilbert in making plantations in Ireland. IV 8, John Champernoun, of Modbury. IV 9, Katherine, daughter of Lord Mountjoy. IV 10 (M's consort), Otho Gilbert, a gentleman of Compton. IV 11 (M), Katherine Champernoun. IV 12 (F), Walter Raleigh, a country gentleman. IV 13 (F's consort), Elisabeth de Ponte. IV 14 (F's consort), Joan Drake.

V 1, Sir Thomas Fulford, of illustrious stock distinguished for its military and naval enterprise. V 3, Gabrielle de Montgomery. V 4, Gawen Champernoun served in France during the civil wars under Count de Montgomery and in other military capacities. V 5, Elisabeth Champernoun. V 6, Sir Edward Seymour. V 7, Henry Champernoun, leader of a band of English volunteers to the Huguenot camp, 1569. *Half Fraternity of Propositus*: V 8, Sir Humphrey Gilbert (1539-1583), was intended for the law, but in 1566 he secured an appointment in the army, having previously petitioned for an expedition in search of the Northeast Passage. He later became a noted navigator and explorer, and perished at sea. V 9, — Aucher. V 10, Sir John Gilbert, a deputy vice admiral of Devon who in 1598 was preparing for an expedition to Guiana with a fleet of 13 ships, but the enterprise did not materialize. V 11, Adrian Gilbert. V 12 (*Propositus*), SIR WALTER RALEIGH. *Fraternity of Propositus*: V 14, Carew Raleigh. V 15, John Radford. V 16, Margaret Raleigh. V 17, Mr. Hull. V 18, George and John Raleigh. V 19, Mary Raleigh. V 20, Hugh Snedale.

V 1, Sir Ferdinando Gorges, a famous navigator and explorer. VI 2, Mary Fulford. VI 3, Bridget Fulford. VI 4, Arthur Champernoun, was "no less fond of adventure, and endowed with no less mental capability, than his ancestors." He was the owner of many vessels and in voyages became widely acquainted with New England. In 1636 secured a large grant of land in Maine. VI 6, Sir John Gilbert. VI 7, Captain Raleigh Gilbert, one of the leaders in the great enterprise of making settlements in North America, especially to the Kennebec river, 1607. *Child of Propositus*: VI 8, Walter Raleigh, was killed in Guiana.

VII 1, Francis Champernoun (1614-1687), one of the early settlers of Maine. "He seems to have had a fondness for maritime life and adventure and to have held some position in the Royal Navy." *Child's child of Propositus*: VII 2, Carew Raleigh.

## BIBLIOGRAPHY.

- DE SELINCOURT, H. 1908. *Great Raleigh*. London: Methuen & Co. xiii + 310 pp.  
 EDWARDS, E. 1868. *The Life of Sir Walter Raleigh*. 2 vols. London: Macmillan & Co.  
 STERLING, W. 1891. *Sir Walter Raleigh*. Oxford: The Clarendon Press. xii + 413 pp.  
 TUTTLE, C. 1889. *Captain Francis Champernowne, The Dutch Conquest of Acadie and other historical papers*. Boston: J. Wilson & Son. xvi + 426 pp.

## 56. JOHN RODGERS.

JOHN RODGERS was born in Harford county, Maryland, in 1773. He attended village school and at about the age of 13 years ran away to Baltimore "to see square-rigged ships," and refused to return home with his father; consequently the latter bound him out for five years as an apprentice to Captain Benjamin Folger, leaving him with an injunction never to touch strong drinks, an injunction he ever followed. Young Rodgers's steady habits, willingness to assume responsibility, and skill as a sailor soon won for him the favorable appreciation of his captain. Before he was 18 years of age he became first mate of the *Harmony*. His apprenticeship completed, his master recommended him, in 1793, to the command of a fine merchant vessel, the *Jane*, 300 tons, plying to European ports. As master of the *Jane*, Rodgers exacted absolute obedience from his crew, who early learned to fear and respect him. In all his career he never lost a vessel or ran one aground. When the United States naval vessel *Constellation* was launched in 1798, Rodgers was appointed her first lieutenant and executive officer (1799). He served under Truxton, displayed great gallantry in the fight (February 9, 1799) with the French frigate *L'Insurgente*, was promoted to the rank of captain, given command of the *Maryland*, a 20-gun sloop, and ordered to watch for enemy (French) vessels at Surinam. When Jefferson (1801) decided upon reducing the size of the American navy, Rodgers's status was for a time uncertain, and during this period he took a schooner of goods to Santo Domingo. Thus he happened to be present at the burning of *Cristophe* by the natives to keep it from falling into the hands of the French, and he there played no insignificant part in saving life and property. By the following year it had been decided to retain Rodgers, and he was sent, in command of the *John Adams* (of 28 guns), to cooperate with Commodore Richard V. Morris against Tripoli. Here he secured an important treaty with the emperor of Morocco and was for a time acting commodore of the Mediterranean squadron. After a trip to the United States, he returned to the Mediterranean, where he soon assumed command, and concluded, with the aid of Consul Tobias Lear, an honorable treaty of peace with the pasha of Tripoli and the release of the prisoners taken from the *Philadelphia*. In the summer of 1805, by taking a bold and spirited position, he secured a favorable treaty with the Bey of Tunis.



From 1809 to 1812 he was in command of the New York flotilla and naval station; he presided at the court-martial of Commodore Barron, superintended the building of 23 gunboats, and performed numerous other duties devolving on a celebrated and effective naval commodore on shore. In 1810 he was sent out with a fleet to protect American merchantmen from having their seamen impressed by the British navy. In command of the *President* he fell in with the *Little Belt* (May 16, 1811), which fired upon his ship and led Rodgers to reply so vigorously, though it was already dark, that the smaller vessel succumbed to him. This event helped to precipitate the War of 1812. Throughout that war he was in active service, fought with the *Belvidere*, and had his leg broken by the explosion of a gun. During the rest of the war he captured many English merchantmen.

After the war was over he was offered the position of secretary of the navy, but declined it. He was then made the head of the board of naval commissioners from 1815 until 1824 and again from 1827 until 1837; he was in command of the squadron in the Mediterranean from 1824 to 1827. His death occurred in 1838, his constitution having been shattered, in 1832, by an attack of Asiatic cholera contracted in Washington while nursing the son of his old friend Tobias Lear.

John Rodgers was a man of about medium height, erect figure, and military carriage. His frame was solid, compact, and well proportioned. His face was stern and imperious. He had a powerful physique, performed feats of skill, and was rarely ill.

John Rodgers' special traits were:

*Absence of fear.* — It is stated that, as a boy, hunting wild ducks on the banks of the mouth of the Susquehanna river, he would sometimes break the ice and swim after the wild duck he had shot and killed from the river bank. He led the boys of his village in many a daring venture (Paullin, 1910, p. 19). Shortly after he had finished his apprenticeship and commanded a merchant ship, he found himself carried by adverse winds into the North Sea, with provisions nearly gone, and with so low a temperature that three of his crew were frozen to death and the rest in sullen despair. When young Rodgers ordered them to go aloft and secure the frozen rigging they refused. But he, stripping off jacket and shirt, went aloft himself to "show them what a man could do." At the age of 23 he witnessed in Liverpool a political procession favoring for Parliament Sir Banastre Tarleton, of ill fame in the American revolution. One banner represented Tarleton on horseback charging a band of fleeing Americans whose national flag was being trampled in the dust by the charging hoofs. When Rodgers saw this banner he pushed his way through the crowd, knocked down the astonished standard-bearer, and returned to the inn. Then, arming himself heavily, he called on General Tarleton, and was assured the banner would be destroyed. A party of Tarleton's supporters carried young Rodgers on their shoulders to his lodgings in admiration of his spirit.

While serving as lieutenant on the *Constellation* under Truxton the French frigate *L'Insurgente* was sighted and engaged in battle, Rodgers commanding one division of the guns. When the French vessel struck her colors Rodgers was ordered to board her and to send the officers to the *Constellation*. There was relatively little loss on the American side. Truxton praised Rodgers's work highly and placed the prize in his charge with 11 seamen. During a storm the following night she separated from the *Constellation* and the 163 prisoners on board planned to seize the ship. Rodgers acted with great promptness and resolution. Seizing

all the small arms, he drove the mutinous men into the lower hold of the ship and stationed at each hatchway a sentinel armed with a blunderbuss, a cutlas, and pistols and gave him orders to fire should the men attempt to force a passage. For two days and three nights Rodgers guarded the prisoners and navigated the ship, being ably assisted by Midshipman Porter. Only by the presence of mind, courage, and vigilance of the young commander were the prisoners held in subjection." After the gale was over *L'Insurgente* rejoined the *Constellation*.

In 1802 he was at Santo Domingo which the French had planned to capture. When the blacks burned Cristophe, Rodgers spent the whole night on shore in rescue and succor. The American consul writes: he "displayed that dauntless spirit which he is known to possess, and saved many lives."

At Tripoli between 1 and 2 o'clock in the morning, he went in a boat to make soundings along shore and observe the position of the enemy's cruisers and gunboats. He went close enough to the shore to hear people conversing with each other.

One spring, at Havre de Grace, when the ice of the river was breaking up and moving down the river with great force, an object was reported to him floating on a block of ice. By means of a spyglass he discovered that it was a woman. Rodgers offered one hundred dollars to any one who would go with him to her rescue, but none accepted the offer.

"Resolving to act alone, Rodgers seized two planks and, by laying them alternately from one piece of ice to another, finally reached the middle of the swollen stream where the frightened woman, now nearly overcome with cold and terror, was still supported on her frail craft [an ice block]. Taking her under his arm, he began his perilous return, which to the great astonishment of the spectators he accomplished, reaching the shore a considerable distance below the town." (Paullin, 1910, p. 173.)

Such was the man who fought the *Little Bell* at night; who remained on deck in the fight with the *Belvidere*, though his leg was broken, and who did more than any other one man to cripple England's commerce during the War of 1812.

Just how the hereditary basis of fearlessness passes through the generations is not known. The father was active in the Revolutionary war, was commissioned captain and possibly became colonel. The mother was a woman of "great energy and strength of character." A brother, George W. Rodgers, received a medal from Congress and a sword of honor from his State for gallantry shown as lieutenant on the *Wasp* in her fight with and capture of the British brig *Frolic*, and was later advanced to the rank of commodore. He died at the age of 45 years.

John Rodgers, by his wife Minerva Denison,<sup>1</sup> had: Robert S. Rodgers, a colonel in the Civil War; Frederick, a midshipman in the United States navy, who was drowned at the age of 17 years while trying to rescue a companion; William Pinkney, a lawyer in New York City; Henry, a lieutenant in the navy, who was

<sup>1</sup> Minerva Denison was the daughter of Gideon Denison (born in 1753), whose father's father's father's father was George Denison (born in England in 1618), excepting Captain John Mason the greatest Indian fighter of colonial days. Minerva Denison's mother was Jerusha Butler (born in 1762), whose father, Benjamin Butler (1739-1787), was of a hyperkinetic temperament, by occupation a blacksmith. He was witty, original (counted "eccentric"), and a strong Tory, who in 1776 was imprisoned on the charge of "defaming the Honorable Continental Congress." His two sons were men of ability; they were educated, but restless.

lost at sea in 1854; Ann Minerva, who married Colonel John Navarre Macomb (a nephew of Alexander Macomb, general in chief of the United States army, 1828-1841), and had two military sons: Augustus F., who became head of the United States Coast Survey party in California, and John Rodgers (born 1812), the most distinguished of the fraternity. He showed the same sort of courage that his father showed. In November 1862 he was ordered to take command of the *Weehawken*, one of the new monitors. On her first cruise out of New York the *Weehawken* encountered a severe gale and doubts were entertained of her ability to keep the sea. But Rodgers refused to put into a refuge near at hand, saying that he was there to test the sea-going qualities of the new class of vessels. In an attack on Fort Sumter, April 7, 1863, he headed the line in the *Weehawken* and remained under fire of the batteries for 2 hours, during which time his vessel was struck 53 times. Two months later the *Weehawken* encountered the armored *Atlanta*, carrying 6 and 7 inch rifles. The *Weehawken* fired 5 shots, 4 of which struck the *Atlanta*, so injuring her that she surrendered. Rodgers became rear admiral in 1869 (Hall, 1909, pp. 81-91). Frederick, the brother who was drowned, showed great courage in his death. With three companions he was capsized in a sailboat; one was drowned immediately. One of the others could not swim and the other two sought, with the aid of an oar, to bring him to shore, but failed. Rodgers, completely exhausted in the effort, also sank before succor arrived. (Paullin, p. 383.)

A second marked trait of John Rodgers was *orderliness and capacity for organization*. From the start he "exacted absolute obedience from his crew." (Paullin, p. 26.) To find out how near his ship might approach the batteries of Tripoli, he sounded systematically at night. As commodore his ships were models of order, neatness, and regularity. He "took much pride in his profession and exacted of his officers an unhesitating obedience and a minute observance of naval customs." (Paullin, p. 163.) Intemperance, because bound to cause disorderliness, he despised. When appointed to his first command, the *Maryland*, he immediately issued a list of 44 regulations and posted them in plain sight of the officers and crew; these related to the ship's economy, cleanliness, gun-practice, and minute observance of naval customs. When, in 1815, a board of navy commissioners was established he was appointed president and held the office for 19 years. This commission issued the most minute and detailed rules concerning the duties of officers, equipment of ships, and the navy-yard. They prescribed the navy ration. These rules remind one, in their detail, of Rodgers' 44 regulations posted on the *Maryland*. But he and his fellow commissioners organized larger matters, such as dry docks, naval hospitals, a naval academy, a national gun factory, and ordnance department. They recommended a system of increase of naval vessels. These recommendations were gradually adopted.

This capacity for organization is found also in his son John, who organized the present Naval Observatory, Washington City. He planned and carried out experiments in acoustics and optics and was one of the founders of the National Academy of Sciences.

John Rodgers had an innate *love of the sea*. As a boy, growing up on the broad estuary of the Susquehanna, he hunted on the sea. It is said that books treating of sailors and seafaring life especially fired his imagination and aroused his curiosity. At about 13 years of age he ran away to Baltimore to see big ships (as stated above), where his father found him and could not prevail on him to

return home. Thereafter he was persistently at sea, except for short rests at home or brief shore duties, until 1815, when he was 42 years of age. After that time he was at sea for comparatively short periods. A similar love of the sea is widespread in the family — in his brother, George W. Rodgers; in his son, John, who entered the navy as midshipman in his sixteenth year (Hall, p. 84), explored the Arctic sea north and northwest of Bering Strait, and in Henry, Augustus F., and Frederick, all of whom were occupied on the sea. Moreover, there are the following grandsons in the navy: Rear Admiral Frederick Rodgers and Rear Admiral John A. Rodgers (who are at the same time grandsons of Matthew C. Perry), and Commander William L. Rodgers, a son of John Rodgers, Jr.

A *willingness to accept responsibility* showed itself early in John Rodgers, even as an apprentice (Paullin, p. 20). As captain of the *New York* he made an honorable treaty with Morocco, without paying a cent for tribute or presents. In treating with the pasha of Tripoli his "conduct during the negotiations on board was mixed with that manly firmness and evident wish to continue the war if it could be done with propriety, while he displayed the magnanimity of an American in declaring that we fought not for conquest but to maintain our just rights and national dignity." (Paullin, p. 139, quoting Consul Tobias Lear.) Similarly he was successful in negotiating a treaty with the Bey of Tunis. His brother, George W., was sent on a diplomatic mission to Brazil. John Rodgers Jr. was, as we have seen, willing to assume responsibility for bringing the monitor *Weehawken* through the gale without seeking shelter. Later, at Valparaiso, the seaport of Chile, which was fighting with Spain, he observed and preserved neutrality, "while endeavoring to mitigate the harsh severities of war." (Hall, p. 89.) The secretary of state of the United States later praised his record in Valparaiso, saying, "enough of his methods have become known to add to his previous reputation, that of being an able negotiator and diplomatist." In 1870 he was sent with Mr. Low, minister to China, to negotiate a treaty with Korea. In this visit he had to punish a bit of Korean treachery. The family of Rodgers thus for two generations was never called on in vain to make momentous decisions touching the honor and prosperity of the nation.

For chart, see the Perry-Rodgers family, No. 50.

#### BIBLIOGRAPHY.

- HALL, A. D. 1909. Biographical Memoir of John Rodgers. (In: National Acad. of Science Biogr. Memoirs. Washington: vol. 6, pp. 81-92.)  
 PAULLIN, C. O. 1910. Commodore John Rodgers. Cleveland: A. Clarke and Co., 434 pp. See Perry, No. 50.

## 57. GEORGE BRYDGES RODNEY.

GEORGE BRYDGES RODNEY was born February 1719. He studied at Harrow, went to sea at 13 years of age, and served for seven years in the Channel fleet. As commander of the *Eagle* (60 guns), he participated in Hawkes's victory off Ushant (October 14, 1747) over the French fleet. The *Eagle* was heavily engaged, had her wheel shot to pieces, but pursued, unsuccessfully, the two French vessels that escaped. In May 1749 he was appointed governor and commander in chief of Newfoundland, with the rank of commodore; but he returned to England in 1752 and was elected to Parliament. He performed well various minor naval duties in the Channel and at Cape Breton (Louisburg), and in 1761, England then being at war with France, he was sent to the Leeward Islands, of which he took several from the French. In the West Indies Rodney took a large view of his duties and tried to adjust his actions to the protection of England's interests, even outside the particular region assigned to him. For a period of fifteen years from 1763 there was peace and Rodney had little to do. He got into money trouble through extravagance and gambling. For five years he was governor of the Greenwich hospital and for three years commander in chief at Jamaica. In 1779 Rodney received orders to command at the Leeward Islands and to relieve Gibraltar, now besieged by Spain, on his way. As good luck would have it, he captured a Spanish convoy of 22 vessels, 7 being warships. Of these 12 were provision ships, which he turned in to feed Gibraltar. Eight days later he defeated the Spanish Admiral de Langara off St. Vincent, taking or destroying 7 ships. Learning at Santa Lucia that a French fleet under De Guichen was sailing from Martinique, Rodney went to meet them. He issued definite orders, but these were not lived up to by all of his captains, so that the French fleet escaped severe injury. Rodney's insistence on discipline during the following two years put his fleet into better shape to meet the next battle with the highly organized French fleet on April 12, 1782. In this battle, between fleets of 33 and 35 ships respectively, Rodney's fleet won a tactical victory, capturing 5 of the enemy's ships and sinking 1. Had the survivors been followed more energetically many of them might have been captured, but as it was the threatened island of Jamaica was saved and French naval prestige was ruined. Rodney seemed to feel that he had done enough and had little desire to fight for the love of fighting; but he was 63 years of age and in poor health. Rodney was made a baron and died ten years later, after having lived in retirement.

Of Rodney, Mahan (1901, p. 151) says:

"Intolerance of dereliction of duty, and uncompromising condemnation of the delinquent, were ever leading traits in Rodney's course as a commander-in-chief. He stood over his officers with a rod, dealt out criticism unsparingly, and avowed it as his purpose and principle of action so to rule. It is not meant that his censures were undeserved or even excessive; but there entered into them no ingredient of pity. His dispatches are full of complaints, both general and specific. When he spared, it was from a sense of expediency — or of justice, a trait in which he was by no means deficient; but for human weakness he had no bowels. Each man has his special gift, and to succeed must needs act in accordance with it. There are those who lead and those who drive; Hawke belonged to one class, Rodney to the other."

## BIBLIOGRAPHY.

MAHAN, A. 1913. *Types of Naval Officers, drawn from the history of the British Navy.* Boston: Little, Brown & Co.

## 58. JOSHUA RATOON SANDS.

JOSHUA RATOON SANDS was born at Brooklyn, New York, May 13, 1795. He entered the navy September 1812, and for a while was with Commodore Chauncey on Lake Ontario. In 1846, as commander of the *Vixen*, he aided in the capture of Alvarado, Tabasco, and Laguna, and was for some time a governor of Laguna. During the bombardment of Vera Cruz he was conspicuous for his bravery, and in 1847 was sent to Washington City with dispatches. In 1857 he was engaged in laying the Atlantic cable, and in 1858 cooperated with Admiral Paulding in the capture at Nicaragua of the filibuster Walker. From 1859 to 1861 he commanded the Brazilian squadron and was retired from active service in 1861, being in his sixty-seventh year. He died at Baltimore in 1883.

His father, Joshua Sands (1772-1825), was a wealthy merchant of New York, for a time collector of the port, and twice elected to Congress. Joshua was brother of Comfort, born at Sands Point, Long Island, about 1740, a merchant and active supporter of the patriot cause. He was a large ship-owner and the eighth president of the Chamber of Commerce, New York.

The mother of Joshua R. Sands was Ann Ascough, whose father Richard was a surgeon in the British army. Probably a nomadic tendency came from this side. A sister of Joshua R., Eliza, married Edward Trenchard (1784-1824), who at the age of 16 decided to enter the United States navy and in 1812 superintended the building of the sloop-of-war *Madison* for Commodore Chauncey on Lake Ontario. She was launched November 26. "Eight weeks before," says Cooper, "her timber was growing in the forest." Trenchard took part in the engagements against the Barbary pirates in 1815-1816. In 1819 he was in command of the *Cyrene*, cruising off Africa to suppress the slave-trade, and fell in with 2 brigs and 5 schooners near the mouth of the river Gallinos. He captured them all and, finding them slavers, shipped officers and crews to the United States. On account of illness he was given shore duty in 1822-1823, and died in Brooklyn in 1824. His son, Stephen D. Trenchard (born at Brooklyn, July 10, 1818), became a midshipman in the navy, 1834. He was long assigned to the Coast Survey, and so distinguished himself in the rescue of the British bark *Adieu*, threatened with shipwreck off Gloucester, Massachusetts, that he received a sword from Queen Victoria. At the outbreak of the Civil War he helped salvage government property at the Norfolk navy-yard and was then given command of the steamer *Rhode Island*. She was detailed to tow the *Monitor* from Hampton Roads to Beaufort, North Carolina, and only by Trenchard's alertness was the whole crew of the *Monitor* saved from drowning when she foundered off Cape Hatteras. Later he captured prizes and Confederate blockade-runners. His only son is an artist who "is most successful in his painting of waves and surf."

A grandson of Comfort Sands is Ferdinand Sands, who married Susan Bard, a daughter's daughter of Nicholas Cruger. Nicholas was a West India merchant who carried on an extensive business at Santa Cruz and was twice captured by the British. Ferdinand and Susan had a son, Louis Joseph Sands, who went as secretary with Joshua R. Sands, his grandfather's first cousin, while laying the Atlantic cable (1857), and later to Nicaragua. During the Civil War he was on the *Seminole* under Admiral Dupont at the capture of Hilton Head, South Carolina. While in temporary command of a small gunboat in the Roanoke river the boat struck a torpedo and several of the crew were killed, while the survivors saved themselves by swimming until picked up by boats. After the war he studied art and devoted himself to painting.

In the case of these naval officers it is probable that some of their most essential qualities came in the maternal germ-plasm; for Joshua R. Sands's mother had a father who was an army surgeon; Stephen D. Trenchard's mother was a sister of Admiral Joshua R. Sands and of Louis Joseph Sands; the mother's mother's father was Nicholas Cruger, the merchant voyager.

#### FAMILY HISTORY OF JOSHUA RATOON SANDS.

I 1 (F F F F F), James Sands (born in England, 1622), came to America in 1658 and became one of the leading men of Block Island. I 2 (F F F F M), Sarah Walker, the only physician and midwife on the island.

II 1 (F F F F), John Sands (1649-1712), a sea captain. II 2 (F F F M), Sybil Ray. *Fraternity of F F F F*: II 4, Sarah Sands. II 5, Mercy Sands. II 6, Joshua Raymond.

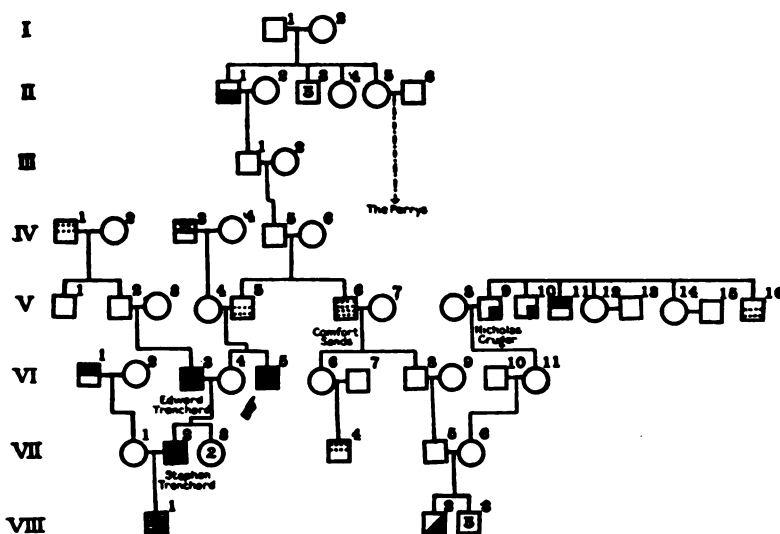

III 1 (F F F), John Sands, born 1683. III 2 (F F M), Catherine Guthrie.

IV 1, George Trenchard, attorney general of west New Jersey in 1767. IV 3 (M F), Richard Ascough, a surgeon in the British army. IV 5 (F F), John Sands (born Block Island, 1708-1709). IV 6 (F M), Elisabeth Cornwell.

V 1, James Trenchard, a designer and engraver of book plates and editor of the *Columbian Magazine*. V 4 (M), Ann Ascough, born 1761. V 5 (F), Joshua Sands (born Sands' Point, New York, October 1757, and died 1835), supplied clothing and provisions for the American army; was collector of customs, port of New York; manufactured rigging and cables for his own vessels; was Congressman and financier. V 6, Comfort Sands (1748-1834), in 1762 went to New York, where he entered upon a mercantile career, commencing business upon his own account in 1769. He was very active during the Revolution, and in 1777 was a member of the State constitutional convention, and for many years afterwards sat in the State legislature. After the war he became a large ship-owner, and from 1794 until 1798 was president of the Chamber of Commerce. V 7, Sarah Dodge. V 8, Ann de Nully, of Santa Cruz, of French and Dutch extraction. V 9, Nicholas Cruger, a West India merchant. V 10, Tileman Cruger, a West India merchant who lived on the island of Curacoa. V 11, John Harris Cruger, was chamberlain of the city of New York and at the outbreak of the Revolution became a lieutenant colonel in the British army. V 16, Henry Cruger, entered a counting-house in Bristol, England, and was elected to Parliament. In 1790 he returned to the United States and became a member of the New York State senate.

VI 1, John Mortimer Barclay, a captain of the United States army. VI 3, Edward Trenchard (1784-1824), in 1800 entered the navy as a midshipman and served with distinction in the West Indies and off Tripoli. During 1811 and 1812 he was executive officer of the New York

navy-yard and saw active service during the war. His arduous duties in helping to suppress the slave traffic on the African coast impaired his health. In 1823 he was honored with the brevet rank of commodore, an exceptional honor, as the rank of captain was then the highest in the service. V 4, Eliza Sands. V 5 (*Propositus*), JOSHUA RATOON SANDS. V 6, Cornelia Sands. V 7, Nathaniel Prime. V 8, Joseph Sands (1772-1825). V 9, — Kampfel, of Lisle, France. V 10, William Bard, born 1778. V 11, Catherine Cruger.

VII 1, Ann O'Connor Barclay. VII 2, Stephen Decatur Trenchard (1818-1883), a rear admiral, 1875. He retired in 1880 after having charge of the North Atlantic squadron, the largest fleet assembled under one head after the war (see text). VII 4, Rufus Prime, a banker of New York City and president of the Chamber of Commerce. VII 5, Ferdinand Sands. VII 6, Susan Bard (1812-1838).

VIII 1, Edward Trenchard (born 1850), a painter of marine scenes who served in the navy and traveled extensively. VIII 2, Louis Joseph Sands (born 1836) (see text), served in the navy and afterwards studied painting.

## BIBLIOGRAPHY.

- DELANCEY, E. 1875. Original Family Records, *Cruger* (In: New York Genealogical and Biographical Record), vol. VI, pp. 74-80.  
 PRIME, T. 1886. Descent of Comfort Sands and of his children. New York. 81 pp.  
 THOMPSON, B. 1843. The History of Long Island. New York: Banks and Co. 2 vols.



## 59. JAMES SAUMAREZ.

JAMES SAUMAREZ was born March 11, 1757, in Guernsey, one of the Channel isles. He had early shown a taste for the navy, so his father, who had 6 sons and a restricted income, arranged with a naval captain to have his name borne on the books of a ship-of-war at the early age of 10. At the age of 18 he was appointed passed midshipman on the *Bristol*, the flagship of Commodore Peter Parker's squadron, then starting out to help quell the rising revolution in America. Lord Cornwallis was on board and was so struck by Saumarez's activity and efficiency that he offered him a commission in his own regiment as his aide-de-camp, but Saumarez, after some hesitation, declined. In his first action against Charleston, South Carolina, the *Bristol* was driven off, but not before Saumarez had shown a bravery that won him a lieutenancy. His gallantry at a fight with a Dutch fleet on the Dogger bank in 1781 resulted in a command. As captain of the *Russell* he fought under Rodney and Sir Samuel Hood in the battle with the French fleet, April 12, 1782. The two fleets passed each other in single file, going in opposite directions, exchanging broadsides. Saumarez, near the head of the column, had cleared the French rear when he saw a neighboring British vessel, commanded by a captain of senior rank, turn out of the line to pursue the enemy. Without orders Saumarez gladly did the same, but, while the former captain (apparently concluding that he should wait for orders) returned to the line, Saumarez kept on after the French ships. Just then, Rodney in the center and Hood in the rear, taking advantage of a favorable wind, started to dash through the enemy's line. The battle-line changed to a confused battle between individual ships and by good fortune the *Russell* engaged the French flagship and had already defeated her when Hood arrived in time to receive her surrender. This brilliant achievement was due to the good fighting sense of Saumarez and his willingness to take responsibility, although only 25 years of age and less than 12 months from his lieutenancy. After 10 years of retirement on land, the outbreak of war with the French in 1793 brought him another opportunity. In the frigate *Crescent* he intercepted on October 20, 1793, the French frigate *Réunion*, which was in the habit of attacking British merchant ships at night. By adroit tactics he succeeded in defeating the enemy's ship, losing one man to 118 of the French. For this exploit he was knighted. Saumarez was now attached to Jervis's fleet and participated in the battle off St. Vincent. Also, he was under Nelson in the battle of the Nile, where his ship *Orion* was largely responsible for the destruction of 3 of the enemy's ships, including the flagship *Orient*, which blew up. Returning to England, Saumarez was given command of the *Cæsar* (84 guns); for 3 or 4 months he blockaded the storm-swept bay of Brest, and in 1800 was sent against the French and Spanish fleet at Cadiz. Learning that 3 French ships had anchored off Algeciras, Saumarez (now rear admiral) went for them with 6 ships-of-the-line, attacked them under the guns of the fortifications, but was defeated, losing one of his ships. However, a few days later, his opportunity came; 2 giant Spanish ships and 4 others of large size appeared, united with the 3 French vessels, and began to engage his 5 wounded ones. At night the swiftest of Saumarez's fleet engaged the Spanish giants, which in the darkness mistook each other for the enemy and destroyed each other. A third was forced to strike her colors. The enemy's fleet was broken up.

In 1809 Saumarez was sent in charge of the Baltic fleet. Napoleon had been making trouble for England in the Baltic countries and Sweden had been forced to declare war against England. Saumarez had here to play the diplomat. He also brought pressure to bear on the countries which had submitted to Napoleon, by destroying their vessels for local commerce while protecting England's trade to and from the Baltic. His wise and temperate conduct later brought praise from a Swedish statesman. Retiring from the Baltic in 1812, Saumarez returned to Guernsey, at the age of 55 years; was made a baron in 1831, and died in 1836, in his eightieth year.

Saumarez is classified by Mahan as primarily a *fighter*, one who would have done as well on land as on the sea. Of his family it is said that many had distinguished themselves in the naval service. Two others of the name were famous in war. James Saumarez married Martha, daughter of Thomas le Marchant, of Guernsey, and had 3 daughters; also 3 sons, of whom one was John, a colonel in the army. James Saumarez had brothers: Philip, a lieutenant in the navy; John Thomas, a general in the army, who fought throughout the American War of Independence; Richard, a surgeon; and Nicholas, without issue.

The father's father was Matthew, a colonel of the militia. A brother of the father was Philip (1710-1747), who was made a captain in the Royal Navy and fell while in command of the *Nottingham* in the naval battle off Brest, October 14, 1747, under command of Lord Hawke. Another brother, Thomas, was a captain in the navy and as commander of the *Antelope*, 50 guns, captured the *Belliqueux* of 64 guns, in the British channel.

FAMILY HISTORY OF JAMES SAUMAREZ.

I 1 (F F), Matthew de Saumarez (born 1685), of the island of Guernsey. I 2 (F M), Anne Durell, daughter of the bailiff of the island of Jersey. I 3 (M F), James le Marchant.

*Fraternity of F:* II 1, John de Saumarez (1706-1773), attorney general of Guernsey. II 3, Philip Saumarez (1710-1747), was first lieutenant with Anson in his voyage around the world and in the expedition to the South Seas. He fell gloriously commanding his ship in Lord Hawke's action off Brest, October 1747. II 4, Thomas Saumarez (1720-1764), was with Lord Anson in his expedition and subsequently, when commander of the *Antelope*, captured a larger vessel in the British Channel. II 5 (F) Matthew Saumarez (1718-1778), was drowned in a passage to England. II 6 (M), Carteret le Marchant. II 7 (consort's F), Thomas Le Marchant, of Guernsey.

*Fraternity of Propositus:* III 1, Philip Saumarez, a lieutenant of the Royal Navy. III 2, John Saumarez (1755-1832). III 3, Thomas Saumarez, was a general in the British army; in 1813 became commander in chief of New Brunswick. III 4, Richard Saumarez, a surgeon of Surrey. III 5, Nicholas Saumarez. II 16, Anne, Charlotte, Mary, and Carteret Saumarez. III 7 (*Propositus*), JAMES SAUMAREZ. III 8 (consort), Martha Le Marchant.

*Children of Propositus:* IV 1, James Saumarez (1789-1863), rector of Huggate, County York. IV 2, Thomas Saumarez (1803-1834). IV 3, John St. Vincent Saumarez (1806-1891), a colonel in the army. IV 4, Mary, Martha, Carteret, and Amelia Saumarez.

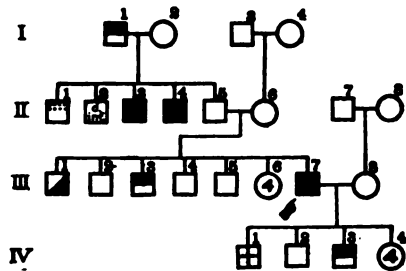

BIBLIOGRAPHY.

BURKE, SIR B., and A. 1909. A Genealogical and Heraldic History of the Peerage and Baronetage. London: Harrison and Sons. 2570 pp.  
 MAHAN, A. 1901. Types of Naval Officers, drawn from the History of the British Navy. Boston: Little, Brown and Co., pp. 382-427.

## 60. RAPHAEL SEMMES.

RAPHAEL SEMMES was born in Charles county, Maryland, September 27, 1809. He was early left an orphan and at 10 years of age was sent to live with his uncle, Raphael Semmes. Here he worked in the wood-yard, roamed the country and received some private schooling. At the age of 16 he was appointed midshipman from Maryland, entered on a cruise to the West Indies and the Mediterranean, and passed an examination as midshipman in 1832. After that he studied law with his brother for two years and for about a year was in charge of naval chronometers. In 1835 he was ordered to the *Constellation* as acting master and cruised chiefly in the West Indies. On his return he was admitted to the bar. He married Anne Elizabeth Spencer, daughter of Oliver M. Spencer and Electra Ogden. In March 1837 Semmes was promoted to a lieutenantcy. It was a period of little naval activity. Semmes was employed in naval routine, in navy-yards, on harbor surveys, etc. He bought land on the Perdido river, Alabama, and settled his family there. He carried a diplomatic message to Vera Cruz and overland to Mexico City; later, he joined the fleet at Vera Cruz in 1846, and there commanded the brig *Somers*, of 10 guns. While on blockading duty his fidelity was noted by the commodore of the fleet. When a blockade-runner went in under the guns of the fort he, with 10 men, rowed to it in the darkness and set fire to the ship, whose cargo of powder soon exploded. In a gale the *Somers* capsized and half of his crew of 100 was drowned, but he was picked up by a boat and eventually succored by a foreign man-of-war. He was exonerated for the loss of his ship. He worked hard at Vera Cruz, landing infantry and cannon, and then attached himself to Scott's army in order that he might be in the fighting. Everywhere his gallantry was praised by his superior officers. Between the Mexican and Civil Wars he commanded various naval vessels and spent five years in Mobile studying and practicing law. In February 1861 he resigned from the Federal service and offered his services to Jefferson Davis, who commissioned him to go north and buy munitions, which he did. Then he proposed that he should go to sea and prey on the enemy's commerce. He learned of a steamer that he thought would do and the next day was off for New Orleans, with the orders, "Do the enemy's commerce the greatest injury in the shortest time." Semmes now lost all of his old inertness and became a new man. He pushed the *Sumter*, whose renovation he completed in two months, through the Mississippi pass with the blockader *Brooklyn* only 5 miles away. He caught several prize ships and took them to a Cuban port; here he argued his right of doing so; but the authorities decided against him and he lost his prizes. When, at the Dutch island of Curaçao, the governor was considering his demand to enter the harbor, he fired a shell near to the council chamber and the governor decided to admit him. At various other ports Semmes had to argue his rights as a belligerent; sometimes he succeeded but usually he failed. At Gibraltar he sold the *Sumter* and sailed for England, and eventually secured the *Alabama*, which had just been finished there. In the following months he captured scores of American merchant ships and held court over doubtful cases, his legal training enabling him to decide in accordance with international law. Finally, in his cruises, he reached Cherbourg in June 1864, and was here met and defeated, offshore, by the *Kearsarge*. He escaped to England. Returning home, he was assigned to the Confederate fleet in the James river (February 1865), and when Richmond was evacuated

he blew up his ship and organized his officers and men as infantry. At the close of the war he returned to Mobile, opened a law office, and practiced law until his death in 1877. He published four books on his experiences.

Semmes was prevailingly *not hyperkinetic*, but calm, cheerful, and occasionally depressed, as, *e.g.*, when in the Indian Ocean. He gave the impression of a grave and reverend professional man rather than of a dashing captain. (Bradford, G., 1904, p. 227.) He was stern in discipline and lashed heavily. In his books he discourses philosophically upon the feudal system and other social conditions in Mexico and argues for the extension of the United States to minimize the influence of single powerful states. He sought to clear up the mystery of the northers, to account for the heavy rainfall of Jalapa and for yellow fever. He argues in his early books for the suppression of privateering and makes use of his legal knowledge and methods in his operations against American commerce, which were strictly in accordance with international law. He was fond of reading literature and was an excellent writer and an entertaining talker. He tended to be somewhat inert in the absence of excitement and, no doubt, like Nelson, found relief in the presence of danger. He had an artist's eye for landscapes and describes them in detail in his writings. His diary reads almost like that of a naturalist, "showing close, intelligent and affectionate observation of nature." (Bradford, 1904, p. 236.) He grew more violent in his expression as he grew older; he always showed a streak of "detestable facetiousness."

Semmes's close relatives were prevailingly lawyers and legislators. On his mother's side he was descended from Arthur Middleton, signer of the Declaration of Independence. His son was for a time in command of a Confederate gunboat.

FAMILY HISTORY OF RAPHAEL SEMMES.

*Ancestor:* Arthur Middleton (1742-1787), came of a line of men prominent in the political life of the country. He was a leader in South Carolina and in 1776 signed the Declaration of Independence. He married Mary Isard. Many of the Middletons and Isards were connected with the navy.

I 1 (consort's F F), Oliver Spencer, mayor of Cincinnati, Ohio.

*Fraternity of F:* II 1, Raphael Semmes of Georgetown, D. C. II 3, Benedict Semmes, a farmer of Maryland; a State legislator and a member of Congress in 1829. II 4 (F), Richard Thompson Semmes. II 5 (M), Catherine Hooe Middleton, died early. II 6 (consort's F), Oliver Marlborough Spencer. II 7 (consort's M), Electra Ogden.

III 1, Thomas Jenkins Semmes (1824-1899), United States attorney in Louisiana, and, during the Civil War, a member of the Confederate States senate.

*Fraternity of Propositus:* III 2, Samuel Middleton Semmes, a lawyer of Cumberland, Maryland. III 3 (*Propositus*), RAPHAEL SEMMES. III 4 (consort), Anne Elisabeth Spencer.

*Child of Propositus:* IV 1, O. J. Semmes was a captain in the Confederate States navy and had command of a gunboat at Grand Lake, Louisiana, March 1863.

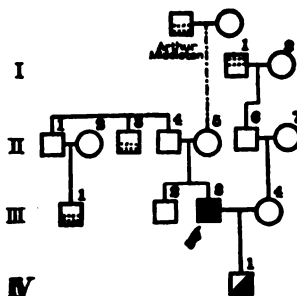

BIBLIOGRAPHY.

ALLEN. 1867. Memorial of Pickering Dodge Allen. Boston: H. W. Dutton and Son. 174 pp.  
 BRADFORD, G. 1904. Confederate Portraits. Boston and New York: Houghton, Mifflin Co. xviii + 291 pp.  
 CHEVES, L. 1900. Middleton of South Carolina. (So. Carolina Historical and Genealogical Magazine, vol. II, pp. 228-282.)  
 MERIWEATHER, C. 1913. Raphael Semmes. Philadelphia: G. Jacobs.

## 61. EDWARD HOBART SEYMOUR.

EDWARD HOBART SEYMOUR was born April 1840. He states of his childhood: "As soon as I had sense enough to form a real wish it was to go to sea — a choice I have never regretted." He entered the British navy in November 1852, after an examination in the rudiments, and in 1853 on the frigate *Terrible* was ordered to the Mediterranean station. In 1854 he took part in the Crimean campaign. In 1857 he went to China and joined the squadron of his father's brother, Sir Michael Seymour, and was made signalman of the fleet. Invalided home on account of illness, he was "made to go back," which he did in 1859. On his homeward journey he leaped into the sea to save a sailor who had fallen overboard. In the western Pacific he was given command of small vessels to go up Canton river to hunt for shipwrecked sailors on the Carolina island, etc. He cruised to the Arctic and saw service in the west coast of Africa, where he was wounded in rescuing Europeans from natives. He had command of the first ship of steel (1880) and later of the *Invincible*, at that time the largest and most powerful ship of the navy. In 1889 he became rear admiral, cruised around the world, was in Chinese waters at the Boxer uprising, and was senior officer in the allied expedition to Peking. In 1902 he was commander in chief at Plymouth.

Seymour belongs to one of England's most distinguished naval families. A father's brother Michael was vice admiral; another father's brother's son, Sir Michael Culme Seymour, is admiral. The latter married Mary Watson, daughter of Lavinia Quin, whose brother Richard was rear admiral. Their mother was a Spencer of a naval family. Edward H. Seymour's father's father was Admiral Sir Michael Seymour, whose wife was a daughter of James Hawkes, a captain in the Royal Navy.

## FAMILY HISTORY OF EDWARD HOBART SEYMOUR.

I 1 (F F F), Rev. John Seymour (died 1795), of Palace, Limerick county. I 2 (F F M), Grisel Hobart, died 1822. I 3 (F M F), James Hawkes, a captain in the Royal Navy. I 5 (M M F), John Smith (died 1819), member of Parliament for Wiltshire. I 6 (M M M), Sarah Gilbert.

II 1, Rev. Thomas Culme. II 3 (F F), Sir Michael Seymour (1768-1834), was an admiral in the Royal Navy who distinguished himself in several gallant actions and died at Rio Janeiro when commander in chief of the Southeast coast of America. II 4 (F M), Jane Hawkes, died 1852. II 5 (M F), Charles Smith (died 1814), of Suttons, Essex county, a member of Parliament. II 6 (M M), Augusta Smith, died 1846.

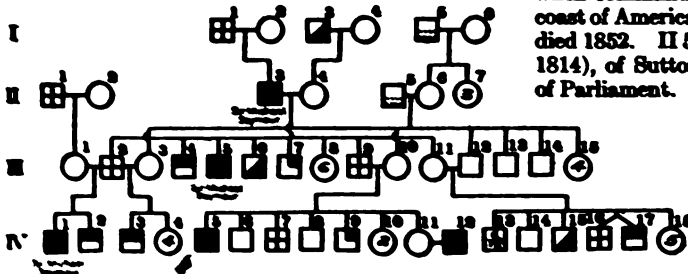

III 1, Elizabeth Culme. *Fraternity of F*: III 2, John Hobart Culme Seymour (1800-1880), canon of Gloucester. III 3, Maria Louisa Smith, died 1887. III 4, James

Seymour (1801-1827), captain in the army. III 5, Sir Michael Seymour (1802-1887), became an admiral in the Royal Navy. He was vice admiral of the United Kingdom and commander in chief of the East Indian station, Canton, and Portsmouth. III 6, Edward Seymour (1804-1837), a captain in the Royal Navy. III 7, William Hobart Seymour (1820-1859), of the army. III 8, Jane, Dora, Mary, Caroline, Elizabeth, and Ellen Seymour. III 9 (F), Richard Seymour (1806-1890), canon of Worcester. III 10 (M), Frances Smith. *Fraternity of M*: III 11, Frances Seymour, died 1897. III 12, Spencer Smith (1806-1882). III 13, Drummond Smith (1812-1832). III 14, Sir Charles Joshua Smith.

IV 1, Sir Michael Culme Seymour (born 1836), was vice admiral of the United Kingdom, commander in chief of the Pacific fleet, of the Channel squadron, and of the Mediterranean fleet. III 2, John Hobart (1837-1887), a lieutenant colonel. IV 3, Henry Seymour (born 1847), re-

ceived his degree of M. A. at Oxford; in the army. IV 5 (*Propositus*), EDWARD HOBART SEYMOUR. *Fraternity of Propositus*: IV 6, Walter Richard Seymour, born 1838. IV 7, Albert Seymour (born 1841), archdeacon of Barnstable. IV 8, Richard Arthur Seymour (1843-1906). IV 9, John Seymour (1843-1866), in the army. IV 11, Augusta. IV 12, Captain St. John Mildmay, of the Royal Navy. IV 15, Seymour Spencer Smith (1841-1893), was a captain in the Royal Navy. IV 16, Rev. Orlando Smith, born 1843. IV 17, Gilbert Joshua Smith, a captain in the army.

## BIBLIOGRAPHY.

BURKE, SIR B., and A. 1909. *A Genealogical and Heraldic History of the Peerage and Baronetage*. London: Harrison & Sons. 2570 pp.  
SEYMOUR, SIR E. 1911. *My Naval Career and Travels*. London: Smith, Elder & Co. 429 pp.

## 62. WILLIAM SIDNEY SMITH.

WILLIAM SIDNEY SMITH was born at Westminster, near London, July 21, 1764. He entered the Navy before he was 12 years of age. For bravery in action near Cape St. Vincent, Portugal, in 1780, he was appointed lieutenant of the *Alcide*. For gallantry in action under Graves off Chesapeake Bay in 1781 and under Rodney at the Leeward islands in 1782, he was made a captain. From 1785 to 1792 he was absent from the service. During the last two years of this period he advised the king of Sweden in the war with Russia. Returning to England he was sent on a mission to Constantinople and, upon his return from that city, attempted to burn the enemy's ships and arsenal at Toulon. Later he hunted French privateers in the Channel and was carried onto the French shore by the tide and wind and made prisoner in April 1796. By means of forged orders for his removal to another prison he escaped to Havre and crossed the Channel in a small skiff in 1798. Appointed to the command of the *Tigre* in the Mediterranean, he learned of Bonaparte's approach to St. Jean d'Acre, hastened to its relief, captured (March 1799) the enemy's flotilla, and compelled Napoleon to raise the siege and retreat in disorder, leaving all his artillery behind. For this brilliant exploit he received the thanks of Parliament. In January 1800 he took upon himself to make a convention with the French by which they were allowed to evacuate Egypt, an act disallowed by his superiors, who required the French to surrender. In 1803 he was commissioned to watch the French in the Channel; in 1806 he was made rear admiral, and the following year was dispatched on secret service for the protection of Sicily and Naples. Here he was led into quarrels with military officers; he relieved Gaeta and captured Capri, but was ordered to leave next year for Malta to act against the Turks. He destroyed the Turkish fleet and spiked the shore batteries. Next he blockaded the Tagus, took the Portuguese royal family to Rio de Janeiro, and was sent as commander in chief to the coast of South America in 1808. Here he quarreled with the British minister and was summarily recalled. He was made vice admiral in 1810 and admiral in 1821, but he was practically retired in 1814. He died in 1840.

William Smith was a typical *hyperkinetic*, like his father, Captain John Smith, who, as aide-de-camp to Lord George Germain, became disgusted with the treatment accorded Germain, left the army, and "passed the greater part of his life in that extraordinary building or boathouse, at Dover, long known as Smith's Folly." The father's father, Captain Edward Smith, commanded a frigate at the attack upon La Guayra, where he received wounds from which he eventually died.

William's hyperkinetic tendencies are shown by his "restless activity and enterprise, his promptness and energy, his good humor and high spirits." He was

a speechless and of unlimited generosity; his manners were lively and agreeable. He showed also a manly daring and determination. Like his father he was tenacious of his opinions, and his vanity and self-assertion led him into collision with his contemporaries. His hyperkinesis was an effective trait in his small naval encounters.

Smith was romantic. On leave at the age of 20, he spent two years in France, visited Spain, journeyed through Morocco, where he volunteered his services in case it was sent to St. Petersburg and to Stockholm, where he became a military adviser of the Swedish king; then returned to the navy. Everywhere he showed restlessness. His mother's sister had a son, Lord Camelford, who entered the navy and became a commander. He shot and killed a lieutenant on another vessel for not obeying his commands; he committed an assault in Drury Lane theater and was found guilty, but disappeared. Five years afterwards he returned to England and was wounded in a duel. In his will he desired that his body should be buried under a certain tree in the canton of Berne, Switzerland, "at whose foot," he says, "I formerly passed many solitary hours, contemplating the mutability of human affairs."

William Smith was of a mechanical turn of mind and interested in inventions. He was a patron of the arts. His memory was so great that he could repeat pages of poetry. He loved to entertain parties of young ladies by clever tricks, charades, and amusements for all of which he demanded as payment a kiss from each. At the age of 76 years, as death was near, he fancied himself as strong or at least as capable of coping with an enemy at sea or ashore as in the prime of life. But this euphoria soon passed into mental and bodily decay until he died of a total paralysis.

#### FAMILY HISTORY OF WILLIAM SIDNEY SMITH.

I: F F F, Captain Cornelius Smith, 1661-1727.

II: F F, Captain Edward Smith, commander of a frigate. II 3 (M F), Pinkney Wilkinson, an equities merchant of London, who disinherited his daughter, Mary. II 5, William Pitt, first Earl Chatham, 1706-1778.

Descendants of F: III 2, General Edward Smith, commander of the Forty-third regiment and governor of Fort Charles, Jamaica. III 3, F, Captain John Smith of the Guards, quitted the service in disgust. III 4, M, Mary Wilkinson, married against her father's wishes. Descendants of M: III 5, — Wilkinsons. III 6, Thomas Pitt, first Baron Camelford, 1737-1793, an English politician.

Descendants of Propositus: IV 1, Charles Douglas Smith, lieutenant colonel and governor of Prince Edward's Island. IV 2, John Spencer Smith (died 1807), held a commission in the Guards but quitted the service to enter the field of diplomacy. He became minister plenipotentiary at Constantinople. IV 4, Propositus, WILLIAM SIDNEY SMITH. IV 5, consort, Lady Caroline Mary —. IV 6, Thomas Pitt, second Baron Camelford, 1773-1804, had an adventurous and wayward career in the navy, attaining the rank of commander. He was finally killed in a duel.

V 1, Edward Herbert Smith, a clergyman of the Established Church. V 2, William Sidney Smith, a captain in the Royal Navy. Children of Propositus: V 4, Captain Arabin, Royal Navy. V 6, Baron de Telmar. V 8, Colonel de St. Clair. V 9, Sir William Rumbold Smith, died in India.

#### BIBLIOGRAPHY.

RANBY, Sir J. 1868. Life of Sir William Sidney Smith. London: Bentley. 2 vols.

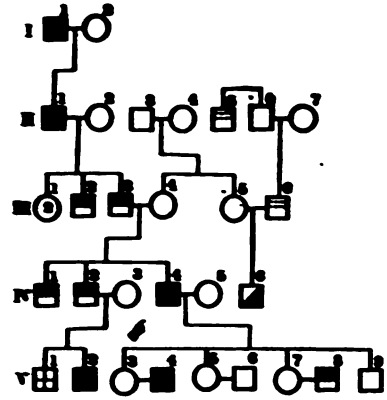

## 63. ROBERT FIELD STOCKTON.

ROBERT FIELD STOCKTON was born at Princeton, New Jersey, August 20, 1795. As a small boy he showed personal courage, a strong sense of honor, hatred of injustice, generosity, and loyalty to friends. At school he was the champion of the weak and won victories over the strong. He entered Princeton College at 13 years of age and stood first in his class. He excelled in elocution and was apt in language and mathematics. The Bible and the writings of Cicero, Shakespeare, and Lord Bacon were his favorite books. One of his professors declared he was the best-informed man he had ever met. He was habitually temperate. He had ability for the law, but the war with England broke out before he was graduated; he was fired with an ambition to excel Nelson and he entered the navy as midshipman and cruised with Commodore Rodgers on the *President* in 1812. When the *President* fought the *Belvidere*, Stockton won the sobriquet "Fighting Bob," and this hung to him ever after. He was in the fight with the *Plantagenet* (74 guns) near Boston for five hours. He went with Rodgers to Washington to see Secretary of Navy Jones, and became Jones's aide, but he shortly after resigned and went with Rodgers to defend Alexandria and later Baltimore. He worked incessantly, building small craft, fire-boats, and rafts. In September 1814 he was commissioned lieutenant. Then came the war with Algiers. Stockton on the *Guerrière* assisted in the capture of the Algerian flagship *Mishouri*. Off the Spanish coast he drove an Algerian brig ashore, led the boarding party in person, got the brig off the shoals, and sent her to a Spanish port. After the war he became first lieutenant on the *Erie*. He now had some leisure and spent it in studying common, martial, and international law and was called upon in courts-martial. He worked for improved discipline and for the abolition of the "cat." He also felt the humiliation of the arrogant attitude of the British naval officers and did his best to end this. A Neapolitan supply-provider came on board the *Erie* with credentials signed by an English naval officer which contained an insulting remark on Yankee seamen. Stockton challenged the subscriber to a duel or apology. They fought and Stockton hit the Englishman in the leg at the first shot. Soon thereafter the *Erie* arrived at Gibraltar. Here he found that an American merchant captain had been thrown into jail as a criminal for failure to carry a lantern at night. The British officer called him a "damned Yankee merchantman." Stockton challenged the English officer to a duel. He wounded the officer and his seconds refused further fight except on their own terms. So Stockton some time later fought on these terms and wounded the officer a second time. The English tried to detain Stockton, who now saw that they were trying to ensnare him. He knocked down one of the foot-guards, pulled another from his horse, mounted the horse, and rode to his own men, who were waiting for him on the shore. The governor of Gibraltar now proceeded to compose the difficulties between the English and Americans. Stockton was opposed to dueling, but a duel seemed the only method of putting the American navy right with the British.

In 1821 Stockton was asked by Judge Washington and Francis Key to aid the Colonization Society to secure a site in Africa. In a naval schooner he set out to look for a healthy locality. Finally, at Cape Mesurado, he found a high, undulating, and fertile country; he began to trade with the natives and finally negotiated with King Peter and, despite the opposition of a powerful mulatto slave-trader, secured the execution of a treaty by which Liberia was acquired;



he then cruised for pirates for a time. In 1825 he married and settled at Princeton on a furlough until 1838. Here he organized the New Jersey Colonization Society, established a newspaper, promoted the building of the Delaware and Raritan canal, largely with his own money, worked for the Trenton and New Brunswick railroad, and took an active part in politics; he also imported and raced thoroughbreds. In 1838, as captain, he commanded the *Ohio* on a cruise to the Mediterranean, and about this time made a model of a steamship with its machinery below the water-line. In 1841 he was offered the secretaryship of the navy, but declined it. He now planned and supervised the building of our first steam war-vessel, *Princeton*. On February 28, 1844, she was being dedicated and a large wrought-iron gun was being fired in the presence of President Tyler, Secretary of State A. P. Upshur, Secretary of the Navy T. W. Gilmer, and others. Stockton stopped firing the gun and refused to continue, but was ordered to fire once more. The gun burst and killed several, including Messrs. Upshur and Gilmer. In 1844 he was sent by President Tyler to carry the annexation resolutions to the government of Texas. In 1845, just before war broke out with Mexico, he was sent in the *Congress* to convey Commissioner Ten Eyck to Honolulu. While at Callao he found that an American merchant captain had been imprisoned while trying to quiet a quarrel between some of his men and some Peruvian sailors. Stockton demanded the release of the captain and was refused in an overbearing manner. He then gave the authorities fifteen minutes to release the man or he would train his ship's guns on the city. The captain was promptly released. At Hawaii he composed the quarrel between the king and the American representative, Brown. He then went to Monterey, California, and organized the citizens of the United States who were in California into a battalion and in 1846 issued a proclamation authorizing civil government in the State. He attacked the Mexicans at Los Angeles and San Pedro, so that the troops fled and the Mexican governor surrendered. Raising an army, he cleared Southern California of the enemy, established a newspaper in San Francisco, and organized schools. Having been superseded, he returned overland to the East, successfully evading threatened Indian attacks *en route*. He was the recipient of distinguished honors in Philadelphia and elsewhere. He resigned from the navy in 1850, to devote himself to private interests and State matters. Elected to the United States senate in 1850, he introduced a bill to abolish flogging in the navy and urged coast defense. Resigning in 1853, he retired to private life. He was elected president of the Delaware and Raritan Canal Company, was chosen a delegate to the peace congress of 1861, and died at Princeton in 1866.

Stockton represents the brilliant "frigate-captain" type — a *dashing hyperkinetic*, who does various jobs well, but organizes no extensive naval campaign. His interest in diplomacy was marked from the time of his youthful study of law. He was intelligent and administrative.

He married Harriet, daughter of John Potter, of Charleston, South Carolina, and had 6 daughters and 3 sons, of whom none became sailors. (1) Richard became a lawyer and treasurer of the Camden and Amboy railroad. (2) John was a lawyer who went as United States minister to Rome, 1857. He was elected United States senator in 1864, and again in 1868; as senator he advocated the establishment of life-saving stations on the coast. He served as attorney general of New Jersey. (3) Robert Field (1802-1898), was graduated at Princeton in 1851, admitted to the bar, became brigadier general in 1858, adjutant general of the State until 1867, and comptroller of New Jersey, 1877-1888. He was

president of the Delaware and Raritan Canal Company and director of the United New Jersey Railroad and Canal Company. This fraternity illustrates how a certain marriage of a nomadic fighter may result in children without his tastes.

The father of Robert Field Stockton, Richard Stockton, was graduated from Princeton and was a leader of the New Jersey bar. Legal talent evidently came from this side, for Stockton's brothers had legal (as well as military) interests. The father's father was Richard Stockton, a signer of the Declaration of Independence and a lawyer of great coolness and courage. He married Annis Boudinot, a literary woman full of courage and high spirit, whose presence of mind enabled her in the Revolution to save important state papers during the battle of Princeton. Her brother Elias was president of the Continental Congress and threw himself heart and soul into the patriotic struggle.

The mother of Robert F. Stockton was Mary Field, daughter of Robert (born 1775) and Mary (Peale) Field, of Burlington, New Jersey. Her brother Robert married Abigail, a sister of Richard Stockton and a daughter of the signer, and had a son, Robert Field (born in 1795), who was a naval officer, but resigned, at the age of 25, upon his marriage, to go on a plantation.

The hyperkinetic tendencies of the propositus probably came from the Boudinot blood, probably reinforced by certain traits of the Field germ-plasm.

FAMILY HISTORY OF ROBERT FIELD STOCKTON.

I 1 (F M F), Elias Boudinot (1706-1770), of Huguenot ancestry. I 2 (F M M), Catherine Williams, of Antigua, of Welsh stock. I 3 (F F F), John Stockton (1701-1758), a man of education and influence, and judge of the court of common pleas; a patron of Princeton College. I 4 (F F M), Abigail Phillips, a first cousin on the Stockton side.

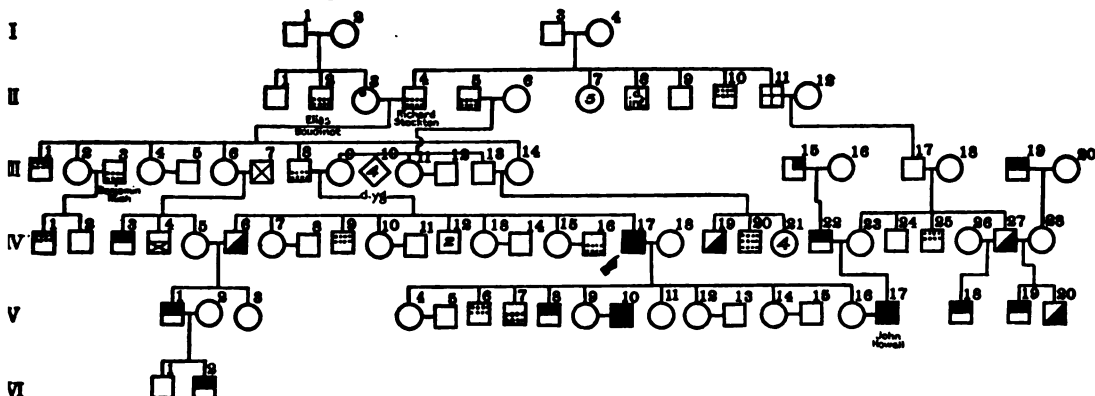

*Fraternity of F M:* II 1, Elisha Boudinot, a lawyer of high reputation. II 2, Elias Boudinot (1740-1821), a lawyer of note; president of the Continental Congress and president of the American Bible Society. II 3, Annis Boudinot (1736-1801), a beautiful and gifted woman, who had some poetical ability and contributed to periodicals. II 4 (F F), Richard Stockton (1730-1781), a jurist of high reputation who signed the Declaration of Independence. II 5 (M F), Robert Field (1723-1775), in 1774 was chairman of a public meeting of Burlington county which sent delegates to the State convention. II 6 (M M), Mary Peale, daughter of Oswald Peale. *Fraternity of F F:* II 9, John Stockton (born 1744), was drowned by the upsetting of a yawl. II 10, Samuel W. Stockton (1751-1795), went as secretary of the American commission to the courts of Austria and Russia, and was secretary of state for New Jersey in 1794. III 11, Rev. Philip Stockton, born 1746.

*Fraternity of F:* III 1, Lucius Horatio Stockton, United States district attorney for New Jersey. III 2, Julia Stockton. III 3, Benjamin Rush (1746-1813), a signer of the Declaration of Independence and a famous physician of Philadelphia. III 4, Susan Stockton. III 5, Alex-

ander Cuthbert, of Canada. III 6, Mary Stockton. III 7, Andrew Hunter (1752-1823), a missionary who became a brigade chaplain in the Revolutionary army and later a chaplain in the navy. III 8 (F), Richard Stockton (born 1764), stood at the head of the bar in New Jersey at the age of 25 years. He was a Presidential elector; a United States senator, and a member of Congress from 1813-1815. III 9 (M), Mary Field (1766-1837). *Fraternity of M*: III 11, Lydia Field. III 12, Adam Hubly. III 13, Robert Field (born 1775), a Princeton graduate. III 14, Abigail Stockton. III 15, Richard Howell (1754-1803), served in the army throughout the Revolutionary war. Afterwards he practiced law and was elected governor of New Jersey. III 16, Miss Burr. III 17, Lucius Stockton (born 1771), a lawyer. III 18, Elisa Core. III 19, Zachary Cantey, a general of South Carolina.

IV 1, Richard Rush (born 1780), attorney general of Pennsylvania and United States minister to England. IV 2, James Rush (born 1786), followed scientific and literary pursuits. IV 3, David Hunter (1802-1886), was graduated from the United States Military Academy at West Point in 1822, but afterwards engaged in business in Chicago (1836). Later he served in the Mexican war and as brigadier general of volunteers won distinction in the Civil War, being made a major general of the United States army in 1865. IV 4, Lewis Boudinot Hunter (born 1804), served as a surgeon in the Mexican and Civil Wars, retiring with the rank of commodore in 1871. IV 5, Mary Hunter. *Fraternity of Propositus*: IV 6, Samuel Witham Stockton, a lieutenant in the United States navy. IV 7, Mary Stockton. IV 8, William Harrison. IV 9, Richard Stockton (born 1791), became judge of the Mississippi supreme court, and attorney general. IV 10, Julia Stockton, born 1793. IV 11, John Rhinelander. IV 13, Caroline Stockton. IV 14, William Rotch. IV 15, Annis Stockton, born 1804. IV 16, Hon. John Renshaw Thomson, United States senator. IV 17 (*Propositus*), ROBERT FIELD STOCKTON. IV 18 (consort), Harriet Maria Potter, of Charleston, South Carolina. IV 19, Robert Field (1767-1850), at 13 years of age shipped before the mast on board a man-of-war with his cousin Robert Stockton. He became a lieutenant in the navy; and in 1822 resigned and took up plantation life in Mississippi. IV 20, Richard Stockton Field (1803-1870), became attorney general of New Jersey, 1838-1844. He was professor of law in the New Jersey Law School (1847-1855), and in 1863 was elected to the United States senate. IV 22, Major Richard Lewis Howell. IV 23, Rebecca Stockton, born 1798. IV 24, Charles C. Stockton (born 1796), removed to Kentucky, where he died young. IV 25, Lucius W. Stockton (born 1799), was the leading spirit in building the historic National Road, the precursor of the trunk-line railroads. IV 26, Mary Remington. IV 27, Philip Augustus Stockton (1802-1876), entered the navy in 1819 and served 11 years. In 1856 he was appointed consul general for Saxony. IV 28, Sarah Cantey (1813-1835).

V 1, Samuel Witham Stockton, an aide on the staff of Major General David Hunter in the Civil War. V 2, Sarah Hodge. V 3, Mary Stockton. *Children of Propositus*: V 4, Catherine Elizabeth Stockton, died 1875. V 5, William Armstrong Dod, a noted preacher and educator. V 6, Richard Stockton (1824-1876), a lawyer, and treasurer of the Camden and Amboy Railroad. V 7, John Potter Stockton (born 1826), was United States minister to Rome in 1857 and as United States senator in 1869 he advocated the establishment of life-saving stations. He became attorney general of New Jersey. V 8, Robert Field Stockton (1832-1898), a lawyer and capitalist; was a brigadier general in 1858 and adjutant general of New Jersey. V 9, Caroline Stockton. V 10, Captain William Rawle Brown, of the United States navy. V 11, Harriet M. Stockton, born 1834. V 12, Julia Stockton, born 1837. V 13, Edward M. Hopkins. V 14, Annis Stockton. V 15, Franklin Howell. V 16, Mary Elizabeth Stockton, born 1830. V 17, John C. Howell (born Philadelphia, 1819), entered the navy in 1836 and served in various capacities; was acting secretary of the navy at various times between 1874 and 1878, being promoted in 1877 to rear admiral. V 18, Howard Stockton (born 1842), was a brevet captain, United States army. V 19, Philip A. Stockton, was graduated from the United States Military Academy; served in the Confederate States army as colonel. V 20, Edward Stockton (born 1849), was a lieutenant in the United States navy; entered the Confederate States navy, afterwards an engineer.

VI 1, Charles Stockton, a civil engineer who died in Nicaragua. VI 2, Samuel Stockton, with the "Rough Riders" in Cuba.

#### BIBLIOGRAPHY.

- BAYARD, S. T. 1856. *A Sketch of the Life of Commodore Robert Field Stockton, with an Appendix*. New York: Derby and Jackson.
- PEIRCE, F. 1901. *Field Genealogy*. Chicago: Hammond Press. 2 vols.
- STOCKTON, T. C. 1911. *The Stockton Family of New Jersey*. Washington: The Carnahan Press. xxviii + 350 pp.

## 64. JOSIAH TATTNALL.

JOSIAH TATTNALL was born November 9, 1795, in Bonaventura, near Savannah, Georgia. He became an orphan at an early age and was sent, with his sister and brother, to England to be educated. At school, from 10 to 16 years of age, his conduct was exemplary and manly; he studied faithfully, but he always retained a strong love for outdoors. In 1811 he returned to America, studied medicine for a time in Savannah, but found it disgusting and depressing, and so, following his inclinations, applied to the navy department and was made a midshipman in April 1812. After studying mathematics for a time in Washington, he was ordered in August to the *Constellation* under Commodore Bainbridge. His first engagement was against the British at Hampton Roads. He helped man the shore batteries on Craney island which repulsed the British barges, and he was one of those who waded out and took possession of the barges which had grounded. Sent on special duty to the Lake Erie squadron, he was detailed to arrest deserters. Having chastised one who resisted arrest, he was criticized for so doing by his commanding officer. Resenting the injustice, he promptly resigned. Later, he was induced to withdraw his resignation and was shortly restored to the navy. In the meantime, however, the English had captured Washington city. Young Tattnall attached himself to a company of volunteers and participated in the disastrous battle of Bladensburg (August 24, 1814). In his rapid retreat he became greatly exhausted and was proffered succor by a planter who discovered him, but he declined. He went with Decatur's squadron to the Algerian war and remained for some time in Mediterranean waters, profiting by its historical surroundings. Upon his return to the United States he was, after examination, promoted to a lieutenancy in April 1818. He next served on the *Macedonian* (on which his intimate friend Paulding was also lieutenant), and sailed for Valparaiso and a Pacific cruise. On account of a disagreement with his captain, he returned to the United States in advance of his ship. He was fully exonerated by the Navy Department.

In 1821 he married a daughter of his mother's sister. While off duty he studied mathematics and also perfected himself in the use of the sword, pistol, and rifle. He was at this time fond of exercise and a rapid and enduring pedestrian. In 1823 he was on the schooner *Jackal*, of Commodore Porter's mosquito fleet, organized to suppress piracy in the West Indies. From 1814 to 1825 he was with the Mediterranean squadron. In 1828 he reported as first lieutenant to Commander Turner on board the *Erie* and, as such, successfully conducted the cutting-out expedition for salvage of the *Federal*.

In 1829 he surveyed the Dry Tortugas for the government fortifications subsequently built there. During the next few years Tattnall saw a varied service on the Gulf of Mexico, connected, more or less directly, with the storm brewing between Mexico, Texas, and the United States. Thus, in 1835, he brought the defeated *Santa Anna* to Vera Cruz, where the soldiery were hostile, and handed him over to his friends. In 1838 he was appointed commander and placed in charge of the Boston navy yard. Next being put in charge of a fine new corvette, the *Saratoga*, he was caught in a southeast gale before he had cleared the New England coast, so that he was nearly driven upon the shore and only saved himself by cutting away the masts and anchoring. After refitting, he carried Commodore Perry, in the *Saratoga*, to the west coast of Africa to watch slavers.

In the Mexican war he commanded the mosquito division of small vessels that covered the landing of General Scott's army at Vera Cruz, and also helped

bombard the city. He bombarded Tuxpan, also, and was wounded severely in the arm by stray shrapnel; consequently he had to return home to recuperate (1847). Sent to the coast of Cuba, where American ships were filibustering, he found that attempts would be made by an American naval commander to release captured American ships in possession of Spanish war-ships on the high seas. Tattnall, realizing that this meant war, so informed the governor general of Cuba, who ordered that all American vessels taken into Cuban ports should be held there and not brought over to Havana harbor. Thus the clash of naval vessels was averted. His course was warmly applauded by his government. In 1857 he was ordered to take charge of the Chma squadron — a well-warranted tribute to his diplomacy. Ordered to take the new American minister to Peking, he was a witness of the English and French attack on the Chinese forts at the mouth of the Pei-ho. In this battle he took a more active part than strict neutrality warranted, but his explanation, "blood is thicker than water," was accepted by our government. He shortly afterward returned to the United States, where he received many honors.

In February 1861, Georgia having seceded, Tattnall resigned from the navy of the United States, reported to the governor of Georgia, and was placed in defense of the waters of South Carolina and Georgia. In this capacity he fought the naval battle of Port Royal harbor and was defeated by the greater force of the enemy. He continued to attack the squadron blockading the Savannah river, erected batteries, and hindered as he could the operation of the Federal naval forces. After the battle between the *Monitor* and the *Merrimac* (the latter commanded by Franklin Buchanan, who was wounded), he was given command of the Confederate fleet at Norfolk, with directions to hoist his flag on the *Virginia* (i.e., the *Merrimac*). This he did, but was unable to fight his ship and, finally, when the Federals captured the Norfolk navy yard, he burned her. He was court-martialed for the act and acquitted. Sent to defend Savannah harbor, he set to work to make a fleet, but this he had to destroy (January 1865) when Savannah was captured. After the war he resided for four years in Halifax, but lack of funds made it necessary for him to return to Savannah, where the post of inspector of the port was created for him (1870). He died June 14, 1871.

Tattnall was *fearless*. As a mere lad he helped salvage the grounded barge of the enemy under the guns of the enemy's fleet. When his captain found a captured American ship, the *Federal*, in the port at St. Bartholomew, it was Tattnall who undertook to row to the vessel, which lay right under the guns of the fort, to hoist her sails and weigh anchor. Just then the midnight exploit was detected by the garrison of the fort, whose cannonading, however, came too late to be effective. Being denounced for this act by an American filibuster, who threatened him with "chastisement at sight," Tattnall "sought the threatener, who then fled at sight of him and went into hiding." When he brought Santa Anna to Vera Cruz and noticed the hostile troops that threatened Santa Anna, Tattnall took his arm and walked with him to the hotel. The mob was so impressed by the boldness of the act that the idea of assassination was replaced by enthusiastic welcome. "Tattnall knew the danger, but danger seemed always a welcome guest to him." Similar courage was shown by his father, also, as when, at the age of 18 years, he left his loyalist father in England and disobeyedly returned to America to fight on the colonial side, and as when, after the war, he organized militia bands to quell Indian troubles in Georgia.

Tattnall's *judgment* in diplomacy was excellent. This may be in part due to the great interest in history which he had from early youth. When at 16 years of age the ship in which he was leaving England for America was held up at Cowes by adverse winds, he says: "I resided on shore and visited places of historical note in the vicinity, thus indulging a natural taste which has increased with the years." Later, when with Decatur's squadron in the Mediterranean, he profited by a long sojourn to examine its historical surroundings. When off duty and not otherwise employed, he was much given to reading. With a well-stored mind, stored especially with historical data, he was able to act wisely, whether in disagreeing with superior officers, preventing a war with Spain over Cuba, or handling a delicate situation with Chinese officials. His judgment in maneuvering his section of the impotent Confederate navy was excellent, and when he was overruled disaster followed. His act in saving the *Saratoga* by cutting away its masts was a novel but an extremely wise method of meeting the emergency. His father, also, must have shown good judgment to gain the ever-increasing regard of his fellow-citizens, which during war brought him rapid promotion and during peace carried him to the governorship of Georgia.

Tattnall had a *keen sense of honor*. When criticized unjustly by a superior officer in the navy he resigned. At Valparaiso he fought one duel and was ready for a second, but could find no antagonist. After the English naval officer had helped him off the shoal of the Pei-ho, on which his vessel had struck, he felt it his duty to help the English officer when he was getting badly whipped in battle with the Chinese fort. He insisted on a court of inquiry and court-martial when criticized for his course in the Confederate navy.

*Generosity* was a marked trait of Josiah Tattnall. He twice made large loans while on the Mediterranean, "as he was easily prevailed upon to do." The first debtor died before he had a chance to repay; with the second Tattnall later quarreled and when, through a friend, the loan was returned, Tattnall, remarking "Tell the gentleman the debt is paid," tossed the money into the sea.

He was *affable and companionable* in his intercourse with his fellow-officers, and with his friends joyous, guileless, and playful. His conversation, "adorned by anecdote, and with a remarkable felicity of illustration, enlivened by humor, and sparkling with wit — was genial and charming in the extreme; with an overflowing spirit of kindness at the helm, neither severity nor sarcasm ever entered there."

He loved the *excitement of warfare*. He writes: "The belief that, even in these dull times, there is a possibility of seeing some service more exciting than mere making and taking in of sail, has given us something of a war animation." When shot, at Tuxpan, it is stated that he cared little for the wound, since the expedition was successful. It is interesting that his father was a successful Revolutionary general and that his mother's sister's son, Christopher Gadsden, commanded the United States brig *Vixen*.

"No man that trod a deck ever came to a decision more promptly than he, or forced its execution through all opposing circumstances with more energy and resolution." His *perception* was like the lightning's flash. The execution followed and with a force sufficient to overcome the resistance to be encountered. This rapidity of thought and action gave to his conduct, at times, an appearance of rashness.



in consequence of his gallantry in action with the English fleet off Leghorn, one of which (the *Phoenix*) he boarded and took after a severe fight, and the rest of which he helped defeat in a bloody battle. He was impetuous, even rash, and not always amenable to discipline.

## BIBLIOGRAPHY.

LIEFDE, JACOB DE. *The Great Dutch Admirals*. London: H. S. King & Co. 351 pp.

## 66. JOHN RANDOLPH TUCKER.

JOHN RANDOLPH TUCKER<sup>1</sup> was born at Alexandria, Virginia, January 31, 1812. He was educated in the schools of his native city. He early showed a longing for the sea and entered the United States navy as midshipman at 15 years of age. He passed some years in the Mediterranean station, and was made lieutenant in 1837. He entered the Mexican war on the *Stromboli*, a bomb-brig, and at its close was lieutenant commander. After additional service in the Mediterranean he was made commander of the *Pennsylvania*, a receiving ship at Norfolk, and was ordnance officer at the New York navy yard when Virginia seceded. He thereupon became a commander in the Confederate navy and was given charge of the *Patrick Henry*, a paddle-wheel steamer, partly protected by iron plates. He took part in the naval battle in Hampton Roads when the *Merrimac* (*Virginia*) rammed and sank the *Cumberland*. After the retreat up the James, the guns of the *Patrick Henry* were placed on Drury's Bluff and used to drive off the Federal ironclad fleet that essayed to pass it. At Charleston, South Carolina, Tucker kept the Federal fleet from attacking the city and helped repulse the attack on Fort Sumter. After the evacuation of Charleston, Tucker went to Richinond and did not leave until he saw the city evacuated. After the war he was offered (in 1866) the command of the Peruvian fleet as rear admiral, accepted it, and commanded the fleets of Peru and Chile in their war with Spain. As president of the Peruvian Hydrographical Commission of the Amazon, he explored the upper courses of that river, coming twice to the United States for light-draft steamers. Again he returned to the States to publish his maps, but, as Peru was now financially unable to pay for the work, Tucker went to Petersburg, Virginia, where he died, in 1883, of heart disease.

His family history has not been well worked out. His father, John Tucker, came to Virginia from Bermuda, and his mother's father, Dr. Charles Douglas, from England.

<sup>1</sup> Rochelle, J. H. 1903. *The Life of Rear Admiral John Randolph Tucker*. Washington: The Neale Publishing Co. 112 pp.



## 67. JOHN ANCREM WINSLOW.

JOHN ANCREM WINSLOW was born at Wilmington, North Carolina, November 19, 1811. He was appointed a midshipman in February 1827. In 1839 he was commissioned a lieutenant; during the Mexican war he took part in various skirmishes on the coast, and was left for six weeks at Tampico to guard the arsenal. After the war he was commissioned a commander, was a light-house inspector for two years and, on the breaking out of the Civil War, was ordered to join Foote's Mississippi River flotilla, which, with half a dozen other officers, he practically constructed. Winslow took two of the flotilla down the river to Cairo. In 1863 he was given command of the *Kearsarge* and was sent to Europe to destroy Confederate cruisers. While off Cherbourg he found the *Alabama* there and received a challenge from her to fight. The fight ensued. The *Alabama* fired rapidly, aimed badly, and was sunk. Winslow fought his ship coolly and with special admonitions against too rapid firing and careless aim. The *Kearsarge* also had the advantage of two 11-inch Dahlgren guns. Promoted to commodore and later to rear admiral, Winslow for two years was in command of the Pacific squadron. He died in 1873. His striking traits were:

*Nomadism.* — As a boy he frequented the docks and shipping of Wilmington, North Carolina, and at the age of 10 years induced his brother Edward to "accompany him upon an impromptu voyage. They cast themselves adrift in a ship's boat, erected a bush for a sail, and, favored by the wind and tide, were swept rapidly to sea." Fortunately they were rescued by an incoming vessel. He liked to roam the woods with his dog. When ready for college he desired to enter the navy and secured a commission.

*Fearlessness.* — He early learned to use firearms, and was given dogs and a gun that he might hunt wild beasts.

He was simple, persevering, steadfast, of indomitable energy, iron will, and defiant courage, yet modest, unassuming, and gentle; he looked more like a divine than a fighter. He combined "in his inheritance the simplicity, perseverance, integrity, and fortitude of the Plymouth Rock Pilgrims with the courage, chivalry, and dash of the gentry of Carolina.

He married his cousin, Catherine Amelia Winslow, daughter of Benjamin Winslow, of Boston, and had, among others, two sons who were in the navy:

Herbert Winslow, born in 1848, was graduated at the United States Naval Academy in 1869; he commanded the United States steamer *Fern* at the battle of Santiago; was in the Boxer Rebellion in China, and landed the first detachment of marines at Taku. He became a rear admiral in 1909 and died in 1914.

William Randolph Winslow was a paymaster in the navy, and died in 1869. He had a son, Eben Eveleth Winslow, who was graduated from West Point at the head of his class in 1869, and became a captain, corps of engineers, United States army.

John A. Winslow's mother's mother's mother's father was Colonel William Rhett, speaker of the House of Commons of South Carolina when he was commissioned as vice admiral in 1704 and placed in command of an improvised naval force. With this he defeated a force of French and Spaniards who sailed against Charleston. In 1716 he captured "Blackbeard," a well-known pirate. Later he was appointed governor general of the Bahamas, but he never accepted the position. "From this hero of Carolina, Winslow inherited the ambition to become a naval warrior and the qualities necessary for success in such a calling."

FAMILY HISTORY OF JOHN ANCRUM WINSLOW.

I 1 (M M M F F), Robert Wright, chief justice of South Carolina. I 3 (M M M M F), William Rhett (1666-1722) (see text). I 4 (M M M M M), Sarah Cooke (1665-1745). I 5, Nicholas Trott (1663-1740), chief justice of South Carolina; a man of profound scholarship and an eminent legal writer.

II 1 (M M F F), James Hasell, chief justice of North Carolina colony. *Fraternity of M M M F*: II 3, Sir James Wright (1714-1785), the last royal governor of Georgia. II 4 (M M M F), Richard Wright (1698-1744). II 5 (M M M M), Mary Rhett (1714-1744). *Fraternity of M M M M*: II 7, Sarah Rhett (1697-1761). II 8, Eleasar Allen, chief justice of North Carolina. II 9, Catherine Rhett (1705-1745). II 11, William Rhett (1695-1728). II 12, Mary Trott.

III 1 (M M F), James Hasell (1727-1769). III 2 (M M M), Sarah Wright (1736-1754). III 3, Sir Thomas Frankland, an admiral of the Royal Navy. III 4, Sarah Rhett, born 1722. III 6, Mary Jane Rhett. III 7, John, eighth Lord Colville.

IV 1 (M F), John Ancrum (died 1779), chairman of the committee of safety in the Revolution. IV 2 (M M), Mary Hasell (1753-1794). IV 5, Sir Thomas Frankland (1750-1831). IV 6, Ann Frankland, died 1842. IV 7, John Lewis, member of the British Parliament. IV 8, Dinah Frankland, died 1795. IV 9, William Bowles. IV 10, Catherine Frankland. IV 11, Sir Thomas Whinyates, an admiral of the Royal Navy. IV 12, Charlotte Frankland. IV 13, Robert Nicholas, member of Parliament. IV 14, William Frankland (died 1816), member of Parliament and lord of admiralty. IV 17, Roger Frankland (died 1816), canon of Wells. IV 18, Catherine Colville.

V 1 (consort's F), Benjamin Winslow, of Boston. V 3 (F), Edward Winslow (born Boston, 1788), in 1807 removed to Wilmington, North Carolina, where he engaged in commercial pursuits. V 4 (M), Sarah Eliza Ancrum, died 1837. V 5 (first consort of M), James McAlister. V 6 (second consort of M), William G. Berry. *Fraternity of M*: V 7, James Hasell Ancrum. V 8, Jane Washington. V 9, Sir Thomas Frankland Lewis (1780-1855); member of Parliament; vice president of the Board of Trade; treasurer of the navy. V 11, Sir William Bowles (died 1869); admiral of the white; K. C. B.

V 12, Sir George Bowles, a general of the army; K. C. B. V 13, Henry Bowles. V 15, Sir Thomas Whinyates, an admiral of the Royal Navy. V 16, Edward Whinyates, a colonel in the British army. V 17, Frederick Whinyates, a captain of engineers, Royal army. V 18, Francis Whinyates, a captain in the East India service. V 20, Edward Nicholas (died 1828), in the diplomatic service. V 21, Robert Nicholas (died 1828),

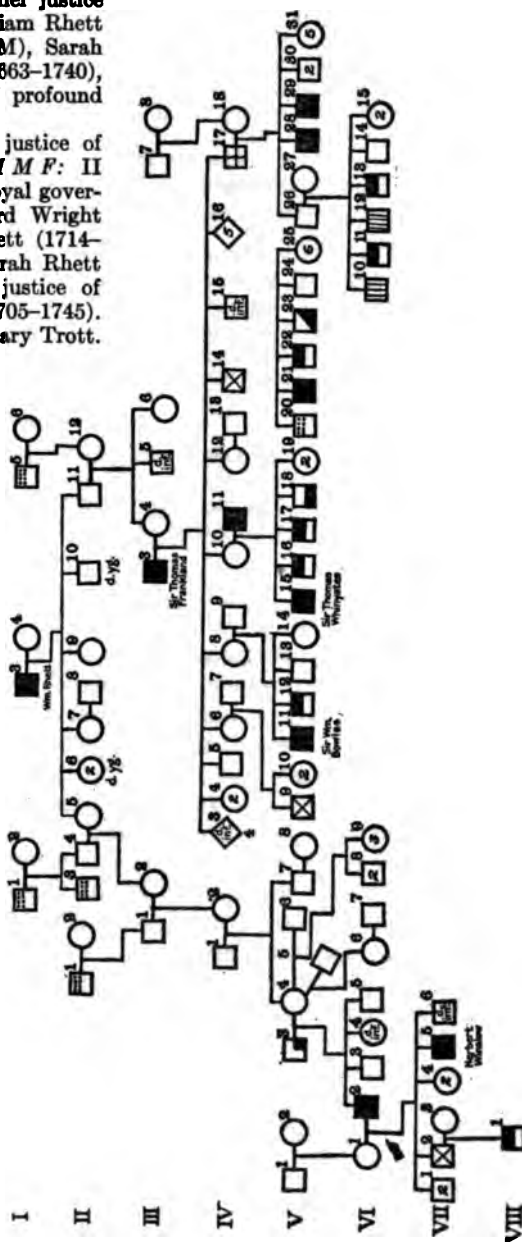

a post captain of the Royal Navy. V 22, William Nicholas, a major in the army; killed at Badajoz, Spain, 1812. V 23, Thomas Nicholas, a lieutenant in the Royal Navy; lost at sea. V 24, Charles Nicholas, a barrister. V 26, Sir Frederick William Frankland (1793-1873). V 27, Katharina Margaret Scarth. V 28, Edward Augustus Frankland, a rear admiral of the Royal Navy. V 29, Charles Colville Frankland (died 1876), an admiral of the Royal Navy.

VI 1 (consort), Catherine Amory Winslow, a cousin. VI 2 (*Propositus*), JOHN ANCRUM WINSLOW. *Fraternity of Propositus*: VI 3, Edward Davis Winslow, born 1810. VI 5, James Hasell Winslow (1816-1830). *Half-fraternity of Propositus*: VI 6, Louisa McAllister. VI 7, Captain James Ward. VI 10, Frederick Roger Frankland, died of fever while a midshipman off Sierra Leone. VI 11, Thomas Frankland (1828-1857), killed at Lucknow. VI 12, Harry Albert Frankland, died while a midshipman off Vera Cruz. VI 13, Sir William A. Frankland (born 1837), a lieutenant colonel of the Royal Engineers.

*Children of Propositus*: VII 1, James (born 1839) and Chilton Rhett (born 1840), Winslow, died unmarried. VII 2, William Randolph Winslow (1841-1869), a paymaster in the United States navy. VII 3, Catherine Eveleth. VII 4, Frances Amory (born 1843) and Mary Catherine (1845-1895), Winslow, died unmarried. VII 5, Herbert Winslow (born 1848) (see text).

*Children's children of Propositus*: Eben Eveleth Winslow (born 1867), graduated at the head of his class from the United States Military Academy in 1889 and became captain, corps of engineers, United States army.

## BIBLIOGRAPHY.

- ELLCOTT, J. 1902. *The Life of John Ancrum Winslow*. New York: C. P. Putnam's Sons. x + 275 pp.  
 HEYWARD, B. 1903. *The Descendants of Col. William Rhett of South Carolina*. (In: *The South Carolina Historical and Genealogical Magazine*. Vol. IV, pp. 37-74: 106-189.)

## 68. WILLIAM WOLSELEY.

WILLIAM WOLSELEY was born at Annapolis Royal, Nova Scotia, in 1756. In 1764 his family removed to Ireland, where he went to school for two years. In 1769 he was put on a naval vessel under the command of the husband of his mother's sister. Two years later he attended a naval school for some months and then sailed to Jamaica as a midshipman. In 1773 he sailed for the East Indies and was gone five years. In 1778 he was, as a lieutenant, in action with the French. Then he was sent again, by his own request, to the East Indies, where he led a storming party at Ceylon and was severely wounded. After participating in four great naval battles in the Indian Ocean, he was made a captain, but he was taken prisoner by the French and released only when peace was declared. In 1785 he was appointed captain of the *Trusty*, the flagship of his mother's brother, Commodore Cosby, in the Mediterranean. In his later years Admiral Wolseley spent most of his time on shore and died in 1842 from the results of an old wound.

Wolseley seems to have been somewhat nomadic and, even in his later years on land, took frequent excursions. He was apparently somewhat hypokinetic — a man of strong religious principles, who secured a high position in the navy by steady good conduct and strict performance of duty. His kindness and amiability won him the affection and esteem of others, including his sailors.

His father's father's father, Captain Richard Wolseley, was in the army under William III, and later was a member of Parliament. From him is descended also Field Marshal Viscount Wolseley, born in 1833. His father was William Neville Wolseley, who, in 1750, was a captain in the Forty-seventh regiment serving in Nova Scotia.

His mother was Ann Cosby, of Nova Scotia. Her eldest brother was a captain in the army and was killed and scalped by Indians in 1748. Her younger

brother, Phillips Cosby, entered the navy and succeeded to the family property in 1774, but was too fond of his profession to exchange it for that of a country gentleman, so he continued to serve and commanded the *Centaur* (74 guns) in an engagement with the French. In the engagement of March 1781, in command of the *Robust* (74 guns) he bore the brunt of the battle. As vice admiral he was put in command of the Mediterranean squadron and in 1790 was made commander in chief of the Irish coast. One notes a strong resemblance between his career and that on the propositus.

Ann Cosby's father was Alexander, the lieutenant governor of Nova Scotia until his death in 1743, and one of his brothers, Lieutenant General William Cosby, was for a time governor of New York and the Jerseys. He died in 1736.

FAMILY HISTORY OF WILLIAM WOLSELEY.

I 1 (F F F), Richard Wolseley, was in the army in Ireland under William III; later was a member of Parliament. I 2 (F F M), Frances Burneston. I 3 (F M F), Mr. Waring, a gentleman of County Kilkenny. I 5 (M F F), Alexander Cosby. I 7 (M M F), Alexander Winniett, of Annapolis Royal.

*Fraternity of F F:* II 1, Richard Wolseley, created a baronet in 1744; member of Parliament. II 3, William Wolseley, fifth baronet. II 4 (F F), Robert Wolseley. II 5 (F M), Miss Waring.

*Fraternity of M F:* II 6, William Cosby (died 1736), a lieutenant general; governor of New York and the Jerseys. II 7, Elisabeth Cosby. II 8, Richard Phillips, governor of Nova Scotia. II 10 (M M), Anne Winniett. *Fraternity of M M:* II 11, — Winnett, a judge.

III 1 (consort's F), John Moore, of County Down. III 3 (F), William Neville Wolseley, a captain in the army, served in Nova Scotia; later he sold out and returned to England. III 4 (M), Anne Cosby. *Fraternity of M:* III 5, Elisabeth Cosby. III 6, Captain Foye. III 7, Captain Charles Cotterhill. III 8, Mary Cosby. III 9, Captain John Buchanan. III 10 William Cosby (died 1748), a captain in the army. III 11, Phillips Cosby (died 1808), rose to the rank of admiral of the white (see text).

IV 1 (consort's B), Hugh Moore, a captain in the army. IV 2 (consort), Jane Moore (died 1820), an amiable and beautiful woman. IV 3 (*Propositus*), WILLIAM WOLSELEY. *Fraternity of Propositus:* IV 5, Elisabeth Wolseley. IV 6, — Lamphier, of the Royal Navy. IV 7, Robert Wolseley, born Annapolis Royal, 1753.

*Children of Propositus:* V 1, John Hood Wolseley (born Ireland, 1796), was a midshipman on the *Superb* and served in the attack upon Algiers, August 1816, being favorably mentioned in the dispatches. Later he was appointed a lieutenant and sailed for Rio Janeiro; died 1827. V 2, Cosby William Wolseley (1805-1868), was appointed in 1828 an ensign in the army, but retired from the army in 1839. He "was intended for the church" but disliked that profession. V 3, Sydney Anne Wolseley (1808-1870). V 4, Colonel John Madden. V 5, Mary Jervis Wolseley (1801-1886). V 6, Arthur Innes, justice of the peace of County Down.

VI 1, Garnet Joseph Wolseley (born Ireland, 1833), distinguished himself in China, India, Canada, Africa, and Egypt and was created a viscount for his services. In 1894 he was promoted to be field marshal and in 1895 he was made commander in chief of the British forces. VI 2, Mary Innes, author of "A Memoir of William Wolseley."

BIBLIOGRAPHY.

INNES, M. 1895. A Memoir of William Wolseley. London: K. Paul, Trench, Trübner & Co. 249 pp.

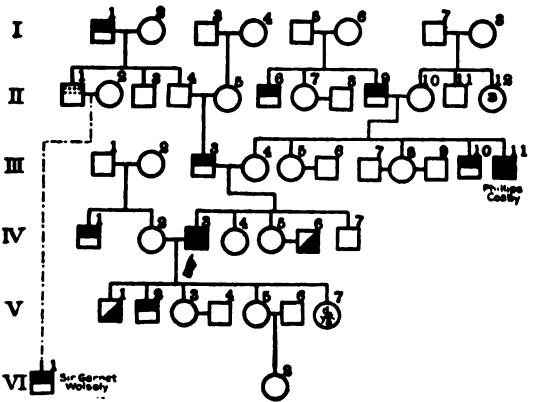



## INDEX.

### NAMES OF PERSONS.

- Abbot, H., 126  
 Abercorn, James, Duke of, 106  
 Adair, Robert, 116  
 Addison, Charles, 136  
     —, Dr. S. Ridout, 136  
 Alava, Admiral, 60  
 Albemarle, Earl of, 117  
 Alessandro, Donna Catalina,  
     78  
 Alexander, Dr., 124  
     —, Sarah, 165  
     —, William, 132  
 Allardyce, A., 78  
 Allen, Eleazar, 213  
 Allen, Ethan, 23, 71  
     —, Pickering Dodge, 199  
 Allington, Lord William, 105  
 Altamont, Lord, Marquis of  
     Stigo, 105  
 Amadas, Joan, 97  
 Ancrem, James H., 213  
     —, John, 213  
     —, Sarah E., 213  
 Anderson, Dorothy M., 159  
     —, Evelina, 179  
     —, Lars, 163  
     —, Philip, 159  
     —, Thomas, 179  
     —, William, 179  
     —, William H., 184  
 André, Major John, 17, 21,  
     155, 156  
 Andrews, Susan, 153  
 Angell, James, 100  
     —, Nathan, 100  
 Anson, George, 106, 108  
     —, Isabella, 105  
     —, Lord, 197  
     —, William, 106, 109  
 Arabin, Captain, 202  
 Armadas, Captain, 185  
 Armstrong, Commodore, 87  
 Armytage, G., 109  
 Arnold, Benedict, 155, 166,  
     168, 202  
     —, Caleb, 168  
     —, Joanna, 168  
     —, Penelope, 168  
 Ascough, Ann, 193, 194  
     —, Richard, 193, 194  
 Atwater, Elisabeth, 90  
 Ancher, —, 186  
 Austin, Julia, 156  
  
 Bacon, Lord, 203  
 Bagwell, Ada, 153  
  
 Bailey, Captain, 160  
 Baillie-Hamilton, Henry, 129  
 Bainbridge, Absalom, 37  
     —, William, 5, 6, 10, 36, 207  
 Baldwin, J., 73, 170  
 Bancroft, Aaron, 45  
     —, Charles, 46  
     —, George, 46  
     —, Henry, 46  
     —, Jane Putnam, 46  
     —, John, 46  
     —, Samuel, 46  
     —, Thomas, 46  
 Bangs, Edward, 183  
     —, Josiah, 182, 183  
     —, Mehitable, 183  
 Banker, Joshua Loring, 63  
 Barber, Susanna, 168  
 Barclay, Ann O'Connor, 195  
     —, John Mortimer, 195  
 Bard, Susan, 193  
     —, William, 195  
 Barker, Mary, 62  
 Barlow, Amica, 184  
     —, Frances Emma, 184  
     —, Francis Joel, 182, 184  
     —, Frederick, 182  
     —, Frederick Stanley, 184  
     —, Harriet, 189, 184  
     —, Joel, 183, 184  
     —, Samuel, 183  
     —, Thomas, 182, 184  
 Barlowe, Captain, 185  
 Barnes, J., 83  
 Barnett, J., 73  
     —, W., 128  
 Barnewall, —, 210  
 Barney, Elisabeth, 38, 39  
     —, George Deverell, 39  
     —, Henry, 39  
     —, James W., 39  
     —, John, 39  
     —, John Holland, 38  
     —, Joseph, 5, 6, 10, 30, 37,  
         38  
     —, Joseph Nicholson, 39  
     —, Joshua, 38, 39  
     —, Louis, 39  
     —, Margaret, 38  
     —, Martha, 38  
     —, Nathan, 39  
     —, Peggy, 38  
     —, William, 38-39  
     —, William Stephenson, 38  
 Barrington, Capt. George, 116  
     —, Mary, 116  
  
 Barron, Sir James, 10, 44, 46,  
     69, 181, 188, 202  
     —, Mary Allen, 44, 46  
 Barrows, Sir John, 106  
 Barry, John, 5, 6, 10, 40, 41, 69  
 Bass, Mary Butler, 62  
     —, Moses Belcher, 62  
 Bassett, Sarah, 134  
 Bayard, S. T., 206  
 Beaver, Edward, 42  
     —, Herbert, 42  
     —, James, 42  
     —, Rev. James, 41  
     —, Philip, 5, 7, 10, 41, 42  
 Bedford, Ann, 38  
     —, Gunning, 38  
 Beeks, L., 174  
 Belcher, Sir Edward, 130  
 Belmont, August, 169, 170  
     —, Fredericka, 170  
     —, Jane Perry, 170  
     —, Oliver Hasard Perry,  
         170  
     —, Perry, 170  
     —, Raymond, 170  
 Bendyshe, John, 145-147  
     —, Richard, 147  
 Benham, Mercy, 89  
 Bennett, Sarah, 89  
 Beresford, Charles, 44  
     —, Lord, Charles William  
         de la Poer, 5, 6, 7,  
         10, 29, 44  
     —, Delaval, 43  
     —, George de la Poer, 43  
     —, George Thomas, 43  
     —, Henry de la Poer, 43,  
         44  
     —, Henry John Talbot, 44  
     —, James, 43  
     —, John, 42  
     —, John George, 43  
     —, Sir John Poo, 43  
     —, John de la Poer, 44  
     —, Marcus, 43  
     —, Sarah Elisabeth, 44  
     —, William, 42, 44  
     —, Viscount William Carr,  
         43  
     —, William Lealie de la  
         Poer, 44  
 Berkeley, Admiral, 131  
 Berner, Dorothy, 146  
 Berry, William G., 213  
 Blackbeard, 212  
 Bladen, Elisabeth, 95

- Bladen, Frances, 95  
 —, Hammond, 95  
 —, Isabelle, 95  
 —, Col. Martin, 95  
 —, Nathaniel, 95  
 —, Thomas, 95  
 Blake, Alexander, 47, 48  
 —, Benjamin, 47, 48  
 —, Charles Follen, 45, 46  
 —, Charles Follen Blood, 45, 46  
 —, Charlotte Caldwell, 46  
 —, Dorothea Ward, 46  
 —, Elizabeth, 46  
 —, Francis, 28, 46  
 —, Francis Arthur, 46  
 —, Francis Barron, 45, 46  
 —, George, 45, 47, 48  
 —, George Smith, 5, 7, 10, 44, 46, 52  
 —, Humphrey, 47, 48  
 —, John, 45  
 —, Joseph Gardner, 46  
 —, Joshua, 45  
 —, Julianna, 46  
 —, Nicholas, 47, 48  
 —, Robert, 5, 6, 10, 28, 29, 47, 48, 122  
 —, Samuel, 47, 48  
 —, William, 46, 47, 48  
 Blanckley, Edmund, 145  
 —, Henry D., 147  
 Bland, Bryant, 146  
 —, Rev. John, 146  
 —, Mary, 146  
 Blaney, Lord, 95  
 —, Sarah, 95  
 Bligh, Capt. William, 83  
 Bogardus, Gen. Robert, 17, 151, 153  
 —, Sarah, 151, 153  
 Boggs, Charles S., 15, 118, 119  
 —, Robert, 118, 119  
 Bolivar, Gen. Simon, 154  
 Bolton, Catherine, 145, 147  
 —, Charles Burrard, 147  
 —, Rev. Edward, 147  
 —, Rev. Edward John, 147  
 —, Elisabeth, 145, 147  
 —, Harriet, 145  
 —, Horatio, 145, 147  
 —, Horatio William, 147  
 —, John Horatio, 147  
 —, Maurice Henry Horatio, 147  
 —, Maurice Horatio, 147  
 —, Susanna, 145  
 —, Thomas, 144, 147  
 —, Sir William, 145, 147  
 —, William Henry, 147  
 Bonaparte, Napoleon, 77, 133, 138, 139, 142, 196, 201  
 Boone, Thomas, 210  
 Booth, John, 92  
 —, Mary, 92  
 Borden, Ann, 54  
 —, Joseph, 53, 54  
 Borden, Mary, 54  
 Borodell, Ann, 72, 168  
 Boudinot, Annis, 205  
 —, Elias, 205  
 —, Eliaba, 205  
 Bouten, Eli, 63  
 —, Mary Isabel, 63  
 Bowen, Harriet, 136  
 —, William, 136  
 —, William Corlis, 136  
 Bowles, Elisabeth, 127, 128  
 —, Sir George, 213  
 —, Henry, 213  
 —, William, 213  
 —, Sir William, 213  
 Boyle, Lady Gertrude, 58  
 Braddock, General, 74  
 Bradford, G., 198, 199  
 Bradley, A. M., 94  
 Brady, C., 70  
 Bartelot, R. G., 94  
 Breed, Edward, 156  
 —, George, 155, 156  
 —, Richard, 156  
 Brenton, Benjamin, 50  
 —, C., 50  
 —, Ebeneser, 50  
 —, Edward P., 49, 50, 103, 109  
 —, Harriet May, 50  
 —, Henrietta, 49  
 —, Isabella, 50  
 —, J., 5, 7, 10, 49, 50  
 —, Sir Jahleel, 49  
 —, James, 50  
 —, James Wallace, 50  
 —, Jervis, 49  
 —, John James, 50  
 —, Sir Launcelet Lee, 50  
 —, Sarah, 89  
 —, William, 49, 89  
 Brereton, General, 140  
 Bridge, Admiral, 47  
 Bridport, Baron, 145  
 —, Samuel, Lord, 147  
 Broke, Captain, 134  
 Brontë, Duchess of, 145  
 Brown, Abigail, 52  
 —, Annie, 52  
 —, Ann Greenough, 52  
 —, Dorothy, 52  
 —, Dorothy Pike, 51  
 —, Capt. Edward, 52  
 —, Elisabeth, 52  
 —, Esther, 52  
 —, James, 52  
 —, John R., 179  
 —, Joseph, 51, 52  
 —, Lawrence, 52  
 —, Lucy, 52  
 —, Mary, 52  
 —, Moses, 5, 10, 28, 51, 52  
 —, Nathan, 52  
 —, Nicholas, 52  
 —, Ruth, 52  
 —, Sarah, 52  
 —, Sarah Coffin, 52  
 Brown, Susanna, 52  
 Brown, William, 51, 52  
 —, William Rawle, 206  
 Browns, Elisabeth, 147  
 Bruce, Lady Mary, 57  
 Brudinel, Anna, 115  
 Bruix, Admiral, 77  
 Buchanan, Adeline, 55  
 —, Alice L., 55  
 —, Andrew, 54, 55  
 —, Ann, 55  
 —, Ann Lloyd, 53  
 —, Ann McKean, 55  
 —, Caroline, 55  
 —, Catherine, 55  
 —, Elisabeth, 55  
 —, Ellen, 55  
 —, Evan Miles, 55  
 —, Franklin, 5, 10, 30, 53, 55, 109, 208  
 —, George, 53, 54, 55  
 —, John, 55, 215  
 —, Joseph, 53, 55  
 —, Letitia, 55  
 —, Mary, 55  
 —, Mary Ann, 53, 55  
 —, McKeen, 53, 55  
 —, Nannie, 55  
 —, Rebecca Susan, 55  
 —, Roberdeau, 55  
 —, Rosa, 55  
 —, Samuel, 55  
 —, Sarah G., 53, 55  
 —, Susan, 55  
 —, Susan Louise, 54  
 —, Susanna, 55  
 —, Thomas, 55  
 —, Thomas McKean, 55  
 —, William Webster, 55  
 Budd, Caroline, 124  
 —, Thomas, 124  
 Buller, Anna Maria, 78  
 —, Sir Edward, 78  
 Bunbury, McClintock, 132  
 —, Miss, 132  
 Bunker, Mary Clement, 66, 67  
 —, Nathan, 67  
 Burdon-Sanderson, John Scott, 75  
 —, Mary Elisabeth, 75  
 Bureau, Pierre, 67  
 Burgoyne, Sir John Fox, 20, 101, 102  
 —, Maria Sophia, 102  
 —, General ("Saratoga"), 15, 101, 102, 157  
 Burke, A., 76, 78, 96, 102, 117  
 —, Sir B., 44, 76, 78, 96, 106, 117, 159, 147, 201  
 —, J., 102  
 Burlingame, Anson, 87  
 Burnestone, Charles, 101  
 —, Frances, 215  
 —, Maude, 102  
 Burr, Miss, 206  
 Burrard, Sir Charles, 147  
 —, Emily, 147  
 Burroughs, Desire, 99, 100

Burroughs, Ezeziel, 99, 100  
 Burton, Mary, 49  
 Burwell, Elisabeth, 110  
 —, Sir Jeffrey, 146  
 —, Mary, 146  
 Bussy, Charlotte Ann, 116  
 Butler, Benjamin, 168, 189  
 —, Jerusha, 168, 189  
 —, Thomas, 168  
 —, William, 168  
 Byng, Georgianna Elizabeth,  
 116  
 Byrd, Jane, 110  
  
 Cable, George W., 161  
 Cabot, Lilla, 169  
 Cadogan, Lady Sarah, 115  
 Calder, Samuel, 124  
 Callender, G., 148  
 Camelford, Lord, 202  
 Campbell, Charles H., 175, 180  
 —, Samuel, 115  
 —, Sophia, 21, 115  
 Cantey, Sarah, 206  
 —, Zachary, 206  
 Cardonnell, Adam de, 128  
 —, Mary de, 128  
 Carew, Sir Edward, 186  
 —, Sir George, 186  
 —, George, 186  
 —, Katherine, 186  
 —, Sir Peter, 186  
 —, Sir William, 186  
 Carey, Hannah, 39  
 Carnegie, George, 108, 109  
 —, Swinford Thomas, 109  
 —, William, 108  
 Carnic, Ann, 124  
 Caroline, Queen, 116  
 Carpenter, George, 43  
 —, Lady Susanna, 43  
 —, Walter Talbot, 44  
 Carrier, Bridget, 108  
 —, Charles, 108  
 —, Elisabeth (or Isabella),  
 108  
 —, James, 108  
 —, Rebecca, 73  
 Carroll, S., 162  
 Carter, Anna Hill, 110  
 —, Mary Walker, 110  
 Catherine of Russia, 112, 113  
 Caulkins, F., 73  
 Cevera, Pascual, 172  
 Chaloner, Frances, 95  
 Chambers, John D., 184  
 Champernoun, Sir Arthur, 186,  
 187  
 —, Elisabeth, 186  
 —, Francis, 187  
 —, Garven, 186  
 —, Henry, 185  
 —, John, 186  
 —, Katherine, 186  
 —, Sir Philip, 186  
 Champlin, Stephen, 165, 168  
 Champneys, Rev. H., 102  
 Chandler, Benjamin, 445

Chandler, Charles, 45  
 —, Clarke, 45  
 —, Dorothy, 45  
 —, Elisabeth, 44, 45  
 —, Elisabeth Augusta, 46  
 —, Francis, 45  
 —, Gardiner, 45, 46  
 —, John, 45  
 —, Lucretia, 45  
 —, Mary, 45  
 —, Nathaniel, 45  
 —, Rufus, 45  
 —, Samuel, 45  
 —, Sarah, 45  
 Chaplain, Jeremiah, 150  
 Chappell, Ann, 83, 85, 92  
 Charles I, 57  
 Charles II, 21  
 Chatham, Lord, 77  
 Chauncey, Commodore, 193  
 Cheves, L., 199  
 Choate, Joseph H., 83  
 Church, Mary, 45  
 —, Ross, 130  
 Churchill, Lady Georgianna  
 Spencer, 106  
 Clark, Elisabeth, 89  
 —, Mehitable, 183  
 —, Rosa Davis, 55  
 Clarkson, Lydia, 149, 150  
 Clayton, Jane, 129  
 Cleary, Mary, 126  
 Clements, Selina, 128  
 Clifford, A., 117  
 —, Baron de, 21  
 Clift, W., 170  
 Clifton, Frances, 128  
 —, Sir Gervase, 128  
 Coale, Edward J., 53, 55  
 —, William S., 55  
 Cochran, Alexander (Blair), 20,  
 57  
 —, Sir Alexander For-  
 rester, 57  
 —, Andrew, 20, 58  
 —, Annette, 58  
 —, Archibald, 58  
 —, Archibald Douglas, 58  
 —, Archibald H., 58  
 —, Arthur, 58  
 —, Sir Arthur A. L., 58  
 —, Arthur H. D., 58  
 —, Basil, 57  
 —, Basil Edward, 58  
 —, Caroline Catherine, 58  
 —, Charles, 20, 57  
 —, Charles D., 58  
 —, Dorothy, 58  
 —, Douglas MacKinnon  
 B. H., 58  
 —, Edith Hamilton, 58  
 —, Edward Owen, 58  
 —, Elisabeth, 58  
 —, Elisabeth K., 58  
 —, Ernest Grey L., 58  
 —, Francis Arthur Charles,  
 58  
 —, George Augustus, 57

Cochran, George Edward  
 Lewis, 58  
 —, Grisel, 58  
 —, Gweryl, 58  
 —, James, 57  
 —, Sir John, 56, 57  
 —, John Palmer, 58  
 —, Katherine, 58  
 —, Louise, 58  
 —, Marjorie, 58  
 —, Ralph Alexander, 58  
 —, Robert, 58  
 —, Roger, 58  
 —, Rosetta, 58  
 —, Thomas, 5, 6, 8, 10, 20,  
 29, 30, 56, 57, 58,  
 129  
 —, Sir Thomas Belhaven,  
 58  
 —, Thomas B. H., 58  
 —, Thomas Erskine, 58  
 —, Thomas George, 58  
 —, Thomas Horatio A. E.,  
 58  
 —, Sir William, 57  
 —, William, 57  
 —, William Erskine, 58  
 —, William Francis, 58  
 Cockburn, Sir William, 109  
 Codman, Capt. Richard, 182,  
 183  
 Coffin, Sarah, 10, 28, 51  
 —, Capt. William, 51  
 Coke, Edward, 115, 117  
 —, Henry John, 117  
 —, Sir Thomas, 115, 116  
 —, Thomas William, 117  
 —, William C., 117  
 Cole, Harriet, 38  
 Coles, Elisabeth Frances,  
 102  
 —, Rev. J. J., 102  
 Collingwood, Cuthbert, 5, 10,  
 59, 60, 138, 139  
 —, Mary Patience, 60  
 —, Sarah, 60  
 —, Wilfred, 60  
 Condé, Prince, 97  
 de Confians, —, 95  
 Cook, Lowly, 89  
 —, Penelope, 105  
 Cooke, Sarah, 213  
 Copeland, Ruth, 62  
 Corcoran, William, 136  
 Core, Eliza, 206  
 Cornwallia, Lord, 22, 90, 168,  
 196  
 —, Elisabeth, 194  
 Cosby, Alexander, 215  
 —, Anne, 214  
 —, Elisabeth, 215  
 —, Mary, 215  
 —, Philip, 23  
 —, Phillips, 214, 215  
 —, William, 215  
 Cotterhill, Capt. C., 215  
 Coville, John Lord, 213  
 —, Catherine, 213



- Cousmaker, Col. George K., 116  
 Cowley, Henrietta, 50  
     —, Joseph, 50  
 Cox, Susan, 184  
 Coyle, Jane, 121  
 Cracroft, Thomas Robert, 92  
 Cranston, Frances, 50  
     —, John, 50  
     —, Samuel, 50  
 Crew, Benjamin, 124  
 Cromwell, Oliver, 41, 128  
 Crosbie, Catherine, 116  
 Cross, Rev. John, 102  
     —, Sally, 182, 183  
 Cruger, Catherine, 195  
     —, Henry, 194  
     —, John Harris, 194  
     —, Nicholas, 193, 194  
     —, Tileman, 194  
 Cuffe, Rosetta, 58  
 Culme, Elisabeth, 200  
     —, Rev. Thomas, 200  
 Cumberland, Duke of, 115  
 Curson, Ernest C. Penn, 106  
     —, Ernest George, 106  
     —, Fits Roy Edmund Penn, 106  
     —, Viscount, Francis Richard, 106  
     —, Frederick, 106  
     —, George Augustus, 106  
     —, Henry D., 106  
     —, Sir Leicester Smyth, 106  
     —, Marianne, 106  
     —, Mary Ann, 106  
     —, Montague, 106  
     —, William Henry, 106  
 Curson-Howe, Asheton Gore, 106  
     —, Penn Asheton, 105  
     —, Richard George Penn, 106  
 Cushing, Alonso, 61, 63  
     —, Howard B., 61, 63  
     —, J. S., 63  
     —, May Isabel, 63  
     —, May R., 63  
     —, Milton, 20, 61, 63  
     —, Dr. Milton B., 61, 62  
     —, Walter, 63  
     —, William Baker, 5, 6, 8, 10, 20, 29, 60, 61, 62, 63, 161  
     —, Zattu, 61  
 Cushings, Wisconsin, 63  
 Cuthbert, Alexander, 206  
  
 Dahlgren, Bernard Ulric, 65, 67  
     —, Sir Carl Adolph, 65, 67  
     —, Charles Bunker, 66, 68  
     —, Elisabeth, 68  
     —, Eric, 67, 68  
     —, Eva, 68  
     —, Johan Adolf, 65, 66, 67  
     —, John, 68  
 Dahlgren, John Adolph, 5, 10, 28, 30, 64, 65, 66, 67, 68, 109, 166  
     —, John Vinton, 67, 68  
     —, Katherine Drexel, 68  
     —, Laurence, 68  
     —, Lucy, 68  
     —, Madeleine, 68  
     —, M. V., 68  
     —, Olga, 68  
     —, Paul, 67, 68  
     —, Ulric, 66, 68  
     —, Ulrica, 68  
     —, William (William de Rohan), 8, 64, 67  
 Daingerfield, LeRoy, 153  
 Dalrymple-Hamilton, Sir Hew, 75  
     —, Janet, 75  
 Danton, —, 81  
 Darlington, Countess, 106  
 Darwin, Charles, 133  
 Davies, Arthur, 145, 147  
     —, W., 60  
 Davis, C., 90  
     —, Jefferson, 198  
 Dean, J., 170  
 Decatur, Etienne, 69  
     —, James, 68, 69  
     —, John P., 69, 70  
     —, Stephen, 5, 6, 12, 68, 69, 70, 120, 207, 209  
     —, Stephen, Jr., 181  
 Deering, Mary, 181, 183  
     —, Nathaniel, 181, 183  
 DeFonblanque, E., 102  
 DeGuichen, —, 192  
 DeKoven, Mrs. R., 114  
     —, Richard, 113  
 De Lancey, E., 195  
 Delaval, George, 43  
     —, Henry, 43  
 De Liefde, —, 9  
 Delmar, Baron de, 202  
 Denison, Bridget, 172  
     —, George, 23, 71, 72, 73, 168, 189  
     —, Gideon, 168, 189  
     —, Minerva, 169, 189  
     —, Samuel, 168  
     —, Sir William, 102  
 Derby, Charlotte, 102  
     —, Edward, Earl of, 102  
 DeRuyter, Michael Adrian-  
     —, soon, 47  
 D'Estaing, Count, 41, 104  
 Deverill, George, 39  
     —, Mary, 39  
 Devons, Caroline, 136  
 Dewey, A., 73  
     —, Charles, 73  
     —, Edward, 73  
     —, Elijah, 72  
     —, George, 70, 71, 73, 168  
     —, George Goodwin, 73  
     —, Jedediah, 71  
     —, Josiah, 71  
     —, Julius Yeomans, 71, 73  
 Dewey, L., 73  
     —, Mary Perrin, 73  
     —, Simeon, 71, 72, 73  
     —, Theodore Gibbs, 73  
     —, William, 71, 72, 73  
     —, William Tarbox, 73  
 DeWitt, Cornelia, 9, 47  
 Dexter, Samuel, 99  
 Dick, Georgiana, 159  
     —, Mungo, 159  
 Dixon, Elizabeth, 179  
     —, H., 48  
 Dobson, Micah, 60  
 Dod, William Armstrong, 206  
 Dodge, Sarah, 194  
 Douglas, Charles, 211  
 Downes, Captain, 80  
 Drake, 96  
     —, Benjamin, 155  
     —, Joan, 186  
     —, John, 186  
     —, Mary, 155  
 Drayton, Captain, 80  
 Drexel, Elisabeth, 67, 68  
     —, Joseph W., 67  
     —, Katherine, 67  
     —, Lucy, 67  
     —, Mary, 68  
 Drowne, H., 170  
 Drysdale, Capt. Thomas, 38  
 Dudley, D., 184  
 Duncan, Adam, 6, 12, 13, 30, 74, 75  
     —, Adam Haldane, 75  
     —, Adamina, 75  
     —, Alexander, 74, 75  
     —, Catherine, 75  
     —, Henrietta, 75  
     —, Henry, 13, 74, 75  
     —, Jane, 75  
     —, John, 74  
     —, Katherine, 75  
     —, Louis, 136  
     —, Margaret, 75  
     —, Mary Tyfton, 75  
     —, Murray, 136  
     —, Richard, 136  
     —, Robert Adam Philips, 75  
     —, Robert (Haldane), 75  
     —, Rev. Thomas, 136  
     —, William, 75, 136  
 Dundas, Anne, 75  
     —, Elisabeth, 75  
     —, Francis, 75  
     —, Henrietta, 75  
     —, Henry, 74, 75  
     —, James, 75  
     —, Margaret, 75  
     —, Philip, 75  
     —, Robert, 74, 75  
     —, William, 75  
     —, William Pitt, 75  
 Dundee, Henrietta, 74  
 Dundonald, Lord (Thomas  
     —, Cochran, q. s.).  
 Dunlop, Annette Elisabeth, 132  
     —, R. F., 132

Dupont, Admiral, 193  
 Durell, Anne, 197  
 Duyn, Adam van der, 115  
 —, Charles van der, 115  
 —, Gertrude van der, 115  
 Dwight, B., 46  
 —, John, 46

Edward VI, 97  
 Eels, Anne Lenthal, 62  
 —, Joseph, 63  
 —, Capt. Robert Lee, 62  
 Edwards, E., 187  
 Egerton, Mrs. F., 102  
 Eliot, Annie, 89  
 —, John (the Apostle), 89  
 —, Joseph, 89  
 Elizabeth, Queen, 97, 98, 185  
 Elliot, Cornelius, 78  
 Elphinstone, A. H., 78  
 —, Annie, 78  
 —, Archibald, 78  
 —, Charles, 78  
 —, Clementina, 78  
 —, Eleanor, 78  
 —, Elizabeth, 78  
 —, Frank, 13  
 —, George Keith, 5, 6, 12, 13, 29, 41, 76, 77, 78  
 —, Georgiana, 78  
 —, Grisell, 78  
 —, James, 78  
 —, James Buller Fullerton, 78  
 —, John, 13, 78  
 —, Keith, 78  
 —, Margaret Mercer, 78  
 —, Mary, 78  
 —, Primrose, 78  
 —, William George Keith, 78  
 Emery, Benjamin, 162  
 Encaster, Duke of, 146  
 Ericason, John, 154  
 Evans, Ellen Lyle, 126  
 Eveleth, Catherine, 214  
 Everett, Captain, 174  
 Eyre, Frances, 147  
 —, Margaret, 153  
 Exmouth, Baron, 158

Fairfax, Althea, 96  
 —, Catherine, 95  
 —, Elisabeth, 96  
 —, Frances, 96  
 —, Isabella, 98  
 —, Mary, 95  
 —, Robert, 96  
 —, Thomas, 95  
 —, William, 95, 96  
 Farnham, Charlotte, 184  
 Farquharson, James Lockhart Ross, 75  
 Farragut, Antonio, 82

Farragut, David Glasgow, 12, 29, 53, 56, 70, 71, 79, 80, 81, 82, 83, 125, 161, 175  
 —, George, 13, 82, 83  
 —, George A., 82  
 —, Jorge, 82  
 —, William, 13, 82  
 Fennel, Elisabeth, 128  
 Fenton, Edward, 97, 98  
 Fenwick, Edward, 210  
 Ferguson, Sir James, 75  
 Ferrard, Viscount, 132  
 Field, E., 100  
 —, Lydia, 206  
 —, Mary, 205, 206  
 —, Mary Peale, 205  
 —, Richard Stockton, 206  
 —, Robert, 205, 206  
 Filchett, —, 1  
 Flagg, Caroline, 90  
 Fleming, Charles Elphinstone, 78  
 —, Clementine, 78  
 —, John, 78  
 —, John Elphinstone, 78  
 Fleury, Dr., 132  
 —, Elisabeth Melesina, 132  
 Flinders, Annie, 84, 85  
 —, John, 84, 85  
 —, Matthew, 5, 8, 12, 30, 83, 84, 85, 91, 92  
 —, Samuel Ward, 83, 84  
 —, William, 133  
 Foley, Captain, 141  
 Folger, Capt. Benjamin, 187  
 Foote, Augustus Edwin, 90  
 —, Andrew Hull, 6, 12, 23, 29, 31, 50, 86, 87, 88, 90, 212  
 —, John, 90  
 —, John Alfred, 89, 90  
 —, Joseph Eliot, 49  
 —, Josephine, 90  
 —, Lucinda, 90  
 —, Mary Ann, 90  
 —, Samuel Augustus, 88, 90  
 —, William, 90  
 —, William Lambert, 90  
 Forbes, Archibald, 170  
 —, Kate L., 63  
 Foster, Captain, 148  
 —, Patience, 132  
 Fowler, Solomon, 155  
 Fox, Charles, 136  
 —, Charles James, 116  
 —, E., 12  
 —, Ebeneser, 90  
 —, Elisabeth, 136  
 —, Helen, 136  
 —, Dr. John, 136  
 —, William, 136  
 Foxhull, —, 152  
 Foye, Captain, 215  
 Frankland, Ann, 213  
 —, Catherine, 213

Frankland, Charles C., 214  
 —, Charlotte, 213  
 —, Dinah, 213  
 —, Edward A., 214  
 —, Frederick R., 214  
 —, Sir F. W., 214  
 —, Harry A., 214  
 —, Roger, 213  
 —, Thomas, 213, 214  
 —, William, 213  
 —, Sir William A., 214  
 Franklin, Benjamin, 99  
 —, Eleanor, 92  
 —, Elisabeth, 92  
 —, Hannah, 92  
 —, Henrietta, 92  
 —, Isabella, 92  
 —, James, 91, 92  
 —, Sir John, 5, 8, 12, 83; 91, 92, 131  
 —, Lady, 131  
 —, Sarah, 92  
 —, Willingham, 91, 92  
 Freeman, Mary, 168  
 French, Jackson Brown, 119  
 Frissell, Hannah, 184  
 Frobisher, —, 97  
 Frowde, James, 158  
 —, Susanna, 158, 159  
 Fulford, Bridget, 187  
 —, Mary, 187  
 —, Sir Thomas, 186  
 Fullerton, Edward Charles Buller, 78  
 —, Elisabeth, 78  
 —, George James Buller, 78  
 —, John Frederick Buller, 78  
 —, William Buller, 78  
 —, Elphinstone William, 78  
 Gadsen, Christopher, 209, 210  
 Gale, Edward F., 63  
 —, Mary Isabel Cushing, 63  
 Gambier, Lord, 56  
 Gardiner, Hannah, 45  
 Garibaldi, Guiseppe, 65  
 Garnier, George, 116  
 —, Thomas, 116  
 —, Dr. Thomas, 116  
 —, William, 116  
 George I, 104, 105  
 George II, 77  
 George, Clara Bartlett, 162  
 —, John H., 162  
 —, Capt. Paul R., 161, 162  
 Germain, Lord George, 201  
 Geyer, Charlotte von, 130  
 —, Frederick von, 130  
 Gherardi, Bancroft, 46  
 —, Donati, 46  
 —, Walter, 46  
 Gibbs, V., 117  
 Gilbert, Adrian, 186

- Gilbert, Sir Humphrey, 19, 185, 186  
 —, Sir John, 19, 186, 187  
 —, Otho, 186  
 —, Capt. Raleigh, 187  
 —, Sarah, 200  
 Gilchrist, Anne, 58  
 —, Capt. James, 57  
 Gillies, John, 42  
 Gilmer, Mary, 159  
 —, T. W., 204  
 Girdlestone, Rev. Henry, 145, 147  
 Gladstone, William E., 116  
 Gleaves, A., 119  
 Goddard, Hon. Daniel Connor, 67  
 —, John, 128  
 —, Madeleine Vinton, 67  
 —, Sarah, 128  
 Goellette, James, 119  
 Goldsborough, H. Howes, 169  
 Gonson, Benjamin, 97  
 —, Katherine, 97  
 —, Thomasine, 97  
 —, William, 97  
 Goodenough, Rev. R. P., 128  
 Goodwin, Ichabod, 73  
 Goodwin, Susie B., 73  
 Gordon, Anne, 74  
 Gore, Sir John, 105  
 Gorges, Sir Ferdinando, 187  
 Goulty, Rev. John, 146  
 Gracie, Anna Maria, 184  
 Graham, John, 74  
 Grant, Jean, 75  
 —, Ulysses S., 87  
 Gray, Andrew, 169  
 Greeley, George Preston, 73  
 Greene, Gen. Nathaniel, 166, 168  
 Greenough, Anne, 52  
 Greenwell, Bernard Esra, 132  
 Griffen, Jane, 92  
 —, William Preston, 119  
 Griffin, W., 164, 165, 166, 167, 170  
 Grosvenor, Ellen, 63  
 Guitart, Ursula, 82  
 Guthrie, Catherine, 194  
 Haddington, George, Earl of, 128  
 Hageman, J., 55  
 Haldane, Daniel Rutherford, 75  
 —, Elizabeth Sanderson, 75  
 —, Capt. James, 74, 75  
 —, James Alexander, 74, 75  
 —, James Aylmer Lowthorpe, 76  
 —, John, 74  
 —, John Scott, 76  
 —, Margaret, 74  
 —, Mungo, 74  
 —, Hon. Richard Burdon, 76  
 Haldane, Robert, 74, 75  
 —, William Stowell, 76  
 Hale, John Parker, 149, 150  
 —, Lydia, 149  
 Halifax, Augusta, 106  
 —, Brigadier General, 106  
 Hall, —, 94  
 —, Abigail, 90  
 —, A. D., 190, 191  
 —, Ann Mary, 90  
 —, Benjamin, 89  
 —, Brenton, 90  
 —, Eihu, 89  
 —, Elisha, 90  
 —, Emma, 89  
 —, Esther, 89  
 —, Gilea, 90  
 —, Hannah, 90  
 —, John, 89  
 —, Jonathan, 90  
 —, Lucy, 90  
 —, Lyman, 89, 90  
 —, Mary, 89  
 —, Nancy, 89  
 —, Rhoda, 89  
 —, Samuel, 88, 89, 90  
 —, Sarah, 89, 90  
 —, Street, 89  
 —, Susanna, 89  
 Halstead, Adm. Sir Lawrence William, 159  
 Hamilton, C., 46  
 —, Frederick F., 117  
 —, George Baillie, 129  
 —, John, 75  
 —, Lady, 138, 139, 141, 144, 147  
 —, Maj. Robert Baillie, 129  
 —, Sir William, 138, 144  
 Hannay, David, 104  
 Hardy, Thomas Masterman, 5, 7, 12, 93  
 Hare, Robert, 26  
 Harriman, Capt. Benjamin, 162  
 Harris, Henry, 100  
 —, T., 87  
 Harrison, Gen. William Henry, 164  
 —, William, 206  
 Hartop, Col. Chiverton, 105  
 —, Mary, 105  
 Harvey, Anne, 186  
 Hasell, James, 213  
 —, Mary, 213  
 Hassler, F. R., 66  
 Hatrell, Jane, 106  
 Haward, Richard, 159  
 Hawe, Mary, 106  
 Hawke, Sir Edward, 12, 23, 95, 96, 104, 192, 197  
 Hawkes, James, 200  
 —, Jane, 200  
 Hawkins, Clare, 98  
 —, Elizabeth, 98  
 —, Francis, 98  
 —, Grace, 98  
 —, John, 5, 12, 20, 30, 96, 97, 98  
 Hawkins, Judith, 98  
 —, Mary, 98  
 —, Nicholas, 98  
 —, Richard, 13, 98  
 —, Sir Richard, 96, 97, 98  
 —, William, 96, 97, 98  
 Hayden, Mindwell, 72  
 Hayes, Capt. Thomas, 37  
 Haywood, M., 83  
 Hasard, C., 170  
 —, George, 168  
 —, Mercy, 167, 168  
 —, Oliver, 167, 168  
 Hasen, Mildred (McLean), 73  
 Heap, Capt. Harris, 179  
 Heathcote, Rev. Thomas, 108  
 Hegel, George William Frederick, 76  
 Henry VIII, 20, 96, 97  
 Hill, Priscilla, 69  
 Hills, Elinor, 73  
 —, Epaphras, 73  
 Hillyar, Captain, 89  
 Hilmore, Mary, 103  
 Hindman, Elizabeth Nicholson, 39  
 Hitchcock, William, 90  
 —, William Augustus, 88  
 —, William R., 88  
 Hobart, Grisel, 200  
 —, James, 73  
 Hodge, Ann Elisa, 169  
 —, Sarah, 206  
 Holcomb, Franklin Porteous, 39  
 —, James, 39  
 —, Rebecca, 39  
 —, Thomas, 39  
 Hone, John, 169  
 Hood, Alexander, 145  
 —, Alexander Nelson, 147  
 —, Lord, 157  
 —, Sir Samuel, 196  
 Hooker, Abigail, 73  
 —, Richard, 38, 60  
 Hopkins, Abigail, 100  
 —, Amy, 100  
 —, David, 136  
 —, Desire, 100  
 —, Edward M., 206,  
 —, Essek, 5, 12, 98, 100, 134, 168  
 —, George, 100  
 —, Heart, 99, 100  
 —, Hope, 100  
 —, John, 13, 99, 100  
 —, John Burroughs, 13, 99, 100  
 —, Lydia, 100  
 —, Rufus, 100  
 —, Ruth, 100  
 —, Samuel, 13, 99, 100  
 —, Simon, 100  
 —, Stephen, 13, 98, 100  
 —, Susanna, 100  
 —, Sylvanus, 100  
 —, Thomas, 99  
 —, William, 99, 100, 168  
 Hopkinson, Ann Borden, 54

Hopkinson, Edward C., 55  
 —, Elisabeth, 55  
 —, Emily, 55  
 —, Francis, 54, 55  
 —, George, 55  
 —, James, 55  
 —, John Joseph, 55  
 —, Joseph, 55  
 —, Thomas Miffin, 55  
 Hoppin, J., 90  
 Hornby, Caroline Lucy, 102  
 —, Charles, 102  
 —, Charlotte, 102  
 —, Edmond, 102  
 —, Edward, 102  
 —, Elisabeth, 102  
 —, Geoffrey, 102  
 —, Geoffrey Thomas  
 Phipps, 5, 7, 14, 20,  
 100, 101, 102  
 —, George, 102  
 —, James John, 102  
 —, Lucy, 102  
 —, Maria Elisabeth, 102  
 —, Phipps John, 102  
 —, Susan, 102  
 —, William, 102  
 Hoste, Dixon, 103  
 —, Edward, 15, 103  
 —, George, 15, 103  
 —, James, 103  
 —, Theodore, 103  
 —, Sir William, 5, 6, 14,  
 103  
 Howe, Charles, 105  
 —, Emanuel, 105  
 —, Emanuel Scrope, 105  
 —, George Augustus, 105  
 —, Harriet Georgiana, 105  
 —, John, Earl of, 105  
 —, Sir John, 105  
 —, Juliana, 105  
 —, Louise Catherine, 105  
 —, Maria, 105  
 —, Richard, 5, 14, 30, 104,  
 105  
 —, Sir Richard Grubham,  
 105  
 —, Richard William Penn  
 Curson, 105  
 —, Robert, 105  
 —, Scrope, 105  
 —, Sophia Charlotte, 105  
 —, Sir William, 15, 103,  
 105  
 Howell, Franklyn, 206  
 —, John C., 206  
 —, Richard, 206  
 —, Richard Lewis, 206  
 Howland, Samuel, 170  
 Hubbard, E., 170  
 —, Henry G., 121  
 Hubley, Adam, 206  
 Huddell, Hannah, 155, 156  
 Huddesfield, Katherine, 46  
 —, Sir William, 186  
 Hull, Andrew, 88, 89, 90, 170  
 —, Caleb, 89

Hull, Elisabeth, 90  
 —, Eudocia, 90  
 —, Commander Isaac, 86,  
 88, 90, 134, 154  
 —, Joseph, 88, 89, 90  
 —, Joseph Bartine, 90  
 —, Marab, 90  
 —, Mary, 88  
 —, Richard, 90  
 —, Sarah, 90  
 —, William, 90, 186  
 Hulse, Mary, 97  
 Hunloke, Charlotte, 116  
 Hunter, Andrew, 206  
 —, David, 22, 206  
 —, Louis Boudinet, 206  
 —, Mary, 206  
 Hussey, Ursula, 97  
 Hyde, Diadema, 168  
 Hyleger, John, 37  
 —, Susan, 36  
 Hyndeford, Janet Elliot, 78  
  
 Innes, Arthur, 215  
 —, Mary, 215  
 Isard, Mary, 199  
  
 Jackson, Ebeneser, 210  
 —, Gen. "Stonewall," 82,  
 175, 210  
 James I., 98, 185  
 Jandon, Ashbel G., 37  
 Jay, Mary, 126  
 Jefferson, Joseph, 2  
 —, Thomas, 187  
 Jeffrey, W., 174  
 Jejeiskjold, Count Charles  
 Louis, 159  
 Jervis, Edward Ricketta, 109  
 —, Henrietta Elisabeth,  
 109  
 —, John, 108  
 —, Admiral John (Lord  
 St. Vincent), 5, 7,  
 14, 59, 76, 107, 108,  
 123, 133, 196  
 —, Martha, 109, 128  
 —, Mary, 108  
 —, Swynfen, 108  
 —, William, 108  
 —, William Ricketta, 108  
 Johnson, Judge R. D., 124  
 —, W., 180  
 Jones, Bathurst, 110  
 —, Catesby ap Rogers, 14,  
 109, 110, 111, 210  
 —, Charles Lucian, 111  
 —, Eusebius, 111  
 —, Frederick, 110  
 —, Jekyl, 110  
 —, John Paul, 5, 6, 8, 14,  
 112, 113  
 —, L. H., 111  
 —, Marck C., 111  
 —, Meriweather, 110, 111  
 —, Philip de Catesby, 110  
 —, Capt. Roger, 5, 110,  
 111

Jones, William, 208  
 —, Samuel, 156  
 —, Skelton, 110  
 —, Col. Thomas, 110  
 —, Thomas ap Catesby,  
 109, 110  
 —, Thomas ap Thomas,  
 110  
 —, Thomas Skelton, 111  
 —, Walter, 110, 111  
 —, William, 110  
 —, William Page, 111  
 —, Winfred Scott, 111  
 Junkins, Martha, 183  
  
 Kampfel, —, 195  
 Kearney, Lawrence, 119  
 —, Michael, 119  
 Keen, Macy, 150  
 Keith, Charles, 77  
 —, Francis Edward James,  
 77, 78  
 —, George, 77, 78 (See El-  
 phinstone, Geo. K.)  
 —, John, 77  
 —, Lady Mary, 78  
 —, Montstuart Elphin-  
 stone, 77, 78  
 —, Robert, Bishop of Fife,  
 78  
 —, William, 77, 78  
 Kellogg, Anna Marie, 155, 156  
 —, George, 156  
 —, Jonathan W., 155, 156  
 —, Warren Comstock, 156  
 Keppel, Ann Amelia, 116  
 —, Arnold Joost van, 115  
 —, Augustus, 21, 115  
 —, Augustus Frederick,  
 116  
 —, Caroline, 116  
 —, Lady Caroline, 116  
 —, Charles, 116  
 —, Sir Colin, 114, 117  
 —, Edward E., 116  
 —, Edward Southwell, 116  
 —, Lady Elisabeth, 116  
 —, Frederick, 116  
 —, George, 115  
 —, George Thomas, 116  
 —, Gertrude Charlotte, 116  
 —, Admiral Henry, 4, 5, 6,  
 14, 21, 29, 74, 114,  
 116, 117  
 —, John, 116  
 —, Leicester Chantry, 117  
 —, Mary, 116, 117  
 —, Rufus, 117  
 —, Sophia, 116  
 —, Rev. Thomas, 117  
 —, Thomas Robert, 116  
 —, Tom, 114  
 —, William, 116  
 —, William Anne, 115  
 —, William Charles, 116  
 —, William Coutts, 117  
 Keroualle, Louise de, Duchess  
 of Portsmouth, 115

- Key, Francis, 203  
 Kibert, Anne, 146  
 Kielmansegge, Baron, 105  
 ———, Mary Sophia Charlotte, 105  
     King, Hannah, 168  
  
 Lacy, General, 66  
 La Fayette, General, 134  
 Lamar, Gen. Mirabeau, 123, 124  
 Lambert, Lady Elizabeth Jane, 109  
 ———, Richard, Earl of Cavan, 108  
 Lamphier, —, 215  
 Langara, Aaron de, 192  
 Langford, Constantia, 158  
 ———, Edward, 158  
 Larnier, Loretta, 124  
 Laroux, Lydia, 121  
 ———, Peter, 121  
 Law, Anna, 89, 90  
 ———, Benjamin, 90  
 ———, Christopher, 90  
 ———, Evan, 128  
 ———, John, 90  
 ———, Jonathan, 89, 90  
 ———, Lyman, 90  
 ———, Mary, 90  
 ———, Richard, 89, 90  
 Lawrence, Anne, 119  
 ———, Elisha, 119  
 ———, Elizabeth, 119  
 ———, James, 5, 6, 14, 29, 118, 119  
 ———, John Brown, 118  
 ———, Katherine, 119  
 ———, Mary, 118, 119  
 ———, Sarah, 119  
 Lear, Benjamin, 136  
 ———, Consul Tobias, 187, 188, 191  
 Lee, Anna, 110  
 ———, E., 111  
 ———, Henry ("Light Horse Harry"), 110  
 ———, Gen. Robert E., 111, 122  
     Sydney Smith, 111  
 Lennard, Frances, 116  
 ———, Sir Thomas, 116  
 Lennox, Lady Anne, 115  
 ———, Charles, 21, 115  
 Leonard, Ann, 119  
 ———, Samuel, 119  
 Leslie, Charles Powell, 43  
 ———, Christine, 43  
 Lewis, John, 213  
 ———, Sir Thomas F., 213  
 Liefde, Jacob de, 210, 211  
 Lilley, Susan Gregg, 73  
 Lincoln, Abraham, 154  
 Linnaeus, Carl von, 65  
 Little, Capt. George, 181  
 Lloyd, Ann, 53, 54  
 ———, Edward, 53, 54  
 Locker, Capt. William, 137  
 Lockhart-Ross, Charles, 75  
  
 Lockhart-Ross, George, 75  
 ———, John, 75  
 ———, Robert, 75  
 Logan, Leavitt C., 175, 180  
 Long, Joshua, 63  
 Loyall, Virginia, 83  
 ———, William, 82  
 Lucy, Constance, 101  
 Lushington, Capt. L. C., 104  
 ———, Louisa, 147  
 Lyman, Hepsibah, 72  
  
 McAlister, James, 213  
 ———, Louisa, 214  
 Macdonald, Sir James, 116  
 Macdonough, Augustine, 121  
 ———, Augustus Rodney, 121  
 ———, Charles Shaler, 121  
 ———, Charlotte Rosella, 121  
 ———, Hannah, 121  
 ———, Hester, 121  
 ———, James Edward Fisher, 121  
 ———, John, 121  
 ———, Joseph, 121  
 ———, Lydia, 121  
 ———, Micah, 120, 121  
 ———, Mary, 121  
 ———, R., 121  
 ———, Samuel, 121  
 ———, Thomas, 5, 6, 14, 21, 29, 12, 121  
 ———, William Joseph, 121  
 MacKensie, Alexander, 30, 70  
 ———, N. S., 165  
 Maclay, E. S., 52, 179  
 Macomb, Alexander, 190  
 ———, Augustus C., 167  
 ———, Col. John Navarre, 169, 190  
 ———, Montgomery Meigs, 169  
 Madden, Col. John, 215  
 Maffitt, Colden Rhine, 124  
 ———, Elisabeth, 123, 124  
 ———, Emily, 123  
 ———, Eugene A., 123, 124  
 ———, Florence, 123, 124  
 ———, Frederick, 124  
 ———, Henrietta, 123, 124  
 ———, John Laurens, 124  
 ———, John Newland, 5, 8, 14, 122, 123, 124  
 ———, Matilda, 123, 124  
 ———, Matilda Caroline, 124  
 ———, Walter C., 124  
 ———, Dr. William, 122, 124  
 ———, William H., 123, 124  
 Magens-Darrien, Magens, 128  
 Mahan, A. T., 2, 4, 5, 7, 9, 14, 77, 80, 81, 83, 95, 96, 109, 125, 126, 139, 140, 141, 142, 144, 148, 157, 159, 192, 197  
 ———, Dennis Hart, 125, 126  
 ———, Frederick Augustus, 126  
  
 Mahan, John, 126  
 Mansfield, William, 128  
 le Marchant, Carteret, 197  
 ———, James, 197  
 ———, Martha, 197  
 Marchant, Susan C., 82  
 Markham, Sir Albert Hastings, 127, 129  
 ———, Alfred, 92, 129  
 ———, Alicia, 128  
 ———, Cecelia, 128  
 ———, Charles, 129  
 ———, Sir Clements, 96, 127, 129, 132, 133  
 ———, Daniel, 128  
 ———, David, 15, 127, 128, 129  
 ———, Edward, 128  
 ———, Sir Edwin, 129  
 ———, Elisabeth, 128  
 ———, Enoch, 128  
 ———, Capt. Francis, 129  
 ———, Frederick, 15, 127, 128, 129  
 ———, George, 128, 147  
 ———, Georgiana, 128  
 ———, Henrietta, 128  
 ———, Henry, 128  
 ———, John, 5, 14, 128, 129  
 ———, Sir John, 127, 128  
 ———, Maria, 129  
 ———, Maria Frances, 129  
 ———, Martha, 128  
 ———, Osborne, 109, 127, 128  
 ———, Robert, 128  
 ———, Warren, 129  
 ———, William, 127, 128, 129  
 ———, William Rice, 129  
 Marryat, Augusta, 130  
 ———, Emily, 130  
 ———, Florence, 130  
 ———, Frank, 130  
 ———, Frederick, 5, 8, 14, 21, 129, 130, 151  
 ———, Horace, 130  
 ———, Joseph, 130  
 ———, Thomas, 130  
 Martin, Emma, 124  
 ———, I. J., 41  
 Marvin, J. S., 41  
 ———, W. L., 28  
 Mary, Queen, 97, 186  
 Mason, Elisabeth, 163, 168  
 ———, Henry, 145, 147  
 ———, Capt. John, 71  
 ———, Minerva, 71, 72  
 ———, P., 90  
 Masserene, Viscountess, 132  
 Matcham, Catherine, 147  
 ———, Charles Hunter, 147  
 ———, Elisabeth, 145, 147  
 ———, George, 145, 147  
 ———, Harriet, 145, 147  
 ———, M., 148  
 ———, Nelson, 147  
 ———, Susanna, 147  
 Matthews, Admiral, 95  
 ———, Cecil, 128

- Maudsley, Capt. Charles, 71**  
**Maxey, Jonathan, 100**  
 —, Susanna, 99  
**M'Cabe, R., 153**  
**McClellan, Alexander, 52**  
 —, George B., 55  
**McClintock, Alfred Henry, 132**  
 —, Lord Bunbury, 131  
 —, Charles Fortescue, 132  
 —, Francis Leopold, 5, 8, 16, 131, 132  
 —, Henry, 132  
 —, Henry Foster, 132  
 —, John, 131, 132  
 —, John William Leopold, 132  
 —, Louis, 132  
 —, Robert Singleton, 132  
 —, Theodore, Ernest, 132  
 —, W. B., 132  
**McDuff, Jeanne, 114**  
**McIven, Eleanor, 82**  
**McKean, Adeline, 55**  
 —, Annie, 54  
 —, Caroline, 55  
 —, Elisabeth, 54, 55  
 —, Franklin Borden, 55  
 —, Letitia, 53, 54  
 —, Mary, 54, 55  
 —, Robert, 54  
 —, Rosa, 55  
 —, Samuel, 55  
 —, Thomas, 11, 53, 54, 55  
 —, William, 55  
**McKeen, Caroline, 124**  
**McKinley, William, 125**  
**M'Knight, Capt. James, 69**  
**M'Nabb, Hon. Sir Alan Napier, 116**  
**McVicar, Francis Brenton, 121**  
**Meade, Annie, 156**  
 —, Charlotte, 156  
 —, Clara, 155, 156  
 —, George Gordon, 156  
 —, Henrietta, 155, 156  
 —, Henry Meigs, 155, 156  
 —, John, 155, 156  
 —, Mary, 155, 156  
 —, Rebecca, 156  
 —, Richard, 155, 156  
 —, Richard Worsam, 155, 156  
 —, Robert, 155, 156  
 —, Robert Learn, 155, 156  
**Meiere, Lieut. Julius, 55**  
**Meigs, Charles, 169**  
 —, Clara Forsythe, 156  
 —, Henry, 156  
 —, John F., 170  
 —, John Rodgers, 169  
 —, Julia Austin, 156  
 —, Louisa, 170  
 —, Mary, 169  
 —, Montgomery, 169, 170  
 —, Theodore, 156  
 —, Vincent, 169  
**Meroer, James, 78**  
**Merchant, Jordan, 82**  
**Merriweather, C., 199**  
 —, Jane, 110  
**Mesquite, Juan, 82**  
 —, Juana, 82  
**Middleton, Arthur, 198, 199**  
 —, Catherine Hoce, 199  
**Miffin, Emily, 55**  
**Mildmay, Capt. St. John, 201**  
**Miles, Evan, 53**  
 —, Hannah, 55  
**Milk, Dorcas, 183**  
**Miller, Annie, 115**  
 —, Sir John, 115  
**Mills, J., 165, 166, 176**  
**Mills, Rev. H. F., 128**  
**Milner, Catherine, 128**  
 —, Sir W., 128  
**Minto, Lord, 142**  
 —, Sophia May, 117  
**Monsey, Robert, Lord Cranworth, 146, 147**  
**Montaudevert, Julia, 119**  
**Montgomery, Count de, 186**  
 —, Gabrielle de, 186  
**Moody, John, 112**  
**Moore, Alexander, 147**  
 —, Alexander M., 147  
 —, Anne, 108  
 —, Hugh, 215  
 —, Jane, 215  
 —, John, 215  
 —, Col. Samuel, 108  
**Moorhouse, G. H., 146, 148**  
**Moresby, Sir Fairfax, 5, 7, 8, 16, 133**  
 —, John, 133  
 —, Robert, 133  
**Morris, Abigail, 134**  
 —, Adolphus, 135  
 —, Benjamin, 135  
 —, Caroline, 136  
 —, Charles, 5, 6, 16, 29, 30, 134, 136  
 —, Charles Wm., 134, 136  
 —, Ebeneser, 135  
 —, Edward, 134, 136  
 —, Elizabeth, 136  
 —, George, 134, 135, 136  
 —, George Upshur, 134, 136  
 —, Hannah, 134  
 —, Harriet Bowen, 136  
 —, Helen Maria, 136  
 —, Henry, 134, 136  
 —, Horace, 134, 136  
 —, John, 134  
 —, Julia Howe, 136  
 —, Lemuel, 134, 136  
 —, Louise Amory, 136  
 —, Lucretia, 134, 135  
 —, Lucy, 136  
 —, Lydia, 136  
 —, Maria, 136  
 —, Maria Lear, 136  
 —, Mary, 136  
 —, Mehitable, 134  
 —, Noadiah, 134, 136  
**Morris, Pardon, 136**  
 —, Com'dore Richard, 187  
 —, Robert, 134, 136  
 —, Robert Murray, 134, 136  
 —, Robert S., 136  
 —, Rufus, 136  
 —, Samuel, 134, 135  
 —, Simeon, 135  
 —, Susanna, 134  
 —, William, 134, 135  
 —, William Bowen, 136  
**Moseley, Hannah, 72**  
 —, Capt. John, 72  
**Mott, Jacob, 168**  
**Mountjoy, Catherine, 186**  
 —, Lord, 186  
**Mulligan, Richard, 156**  
 —, Virginia, 155, 156  
**Mulryn, Sir John, 210**  
**Mumford, Hannah, 89**  
 —, Sarah, 136  
**Murray, Isabella, 74**  
 —, J., 42, 106  
 —, Sallie Scott, 54  
**Murrell, Mary Florence, 124**  
**Musgrave, Augusta, 58**  
**Naile, Lieut. Raymond, 155**  
**Napier family, 21**  
**Neale, Raymond, 156**  
**Neill, E., 96**  
**Nelson, Anne, 145, 147**  
 —, Catherine, 145  
 —, Charlotte, 145, 147  
 —, Edmund, 145, 146, 147  
 —, Horatio, 1, 2, 3, 4, 5, 6, 7, 16, 20, 24, 29, 59, 81, 88, 133, 134, 137, 138, 140, 142, 143, 144, 158, 168, 196, 203  
 —, Maurice, 144, 147  
 —, Rear-Adm. Maurice Horatio, 144  
 —, Suckling, 145, 147  
 —, Susanna, 144, 145, 147  
 —, T., 148  
 —, William, 144, 147  
**Nicholas, Charles, 214**  
 —, Edward, 213  
 —, Robert, 213  
 —, Thomas, 214  
 —, William, 213  
**Nichols, Capt. Jonathan, 134**  
 —, Miriam, 136  
**Nicholson, James, 38**  
 —, John, 38  
 —, Samuel, 38  
**Niles, J., 170**  
**Nisbit, Dr. Josiah, 138**  
**Norreys, Sir Henry, 186**  
 —, Mary, 186  
**Nottingham, John Henry, 152**  
**Nully, Ann de, 194**  
**Nutthall, John, 109**  
**Nye, David, 73**

- O'Brien, Dennis, 149, 150  
 —, Gideon, 149, 150  
 —, Jeremiah, 5, 6, 16, 21,  
 29, 148, 149, 150  
 —, Joana, 150  
 —, John, 148, 149, 150  
 —, Joseph, 149, 150  
 —, Lydia, 150  
 —, Maria, 150  
 —, Martha, 150  
 —, Mary, 150  
 —, Morris, 148, 150  
 —, William, 149, 150  
 O'Bryne, W., 109, 148  
 Oddie, Walter, 156  
 Ogden, Electra, 198, 199  
 Okill, John, 126  
 —, Mary Helena, 126  
 Orange, Prince of, 103  
 Orton, Sarah, 71  
 Ostrander, Jane, 173  
 Oxnard, Ebeneser, 183  
 —, Edward, 183  
 —, Enoch, 184  
 —, Henry, 184  
 —, John, 184  
 —, Martha, 184  
 —, Mary, 184  
 —, Mehitable, 184  
 —, Stephen, 184  
 —, Thomas, 182, 183  
 Page, Alexina, 111  
 —, Charles, 111  
 —, Edmonia, 111  
 —, Fanny, 111  
 —, Hugh Nelson, 110  
 —, Jane, 110  
 —, John, 110  
 —, Lewis Burwell, 110  
 —, Mann, 110  
 —, Mary Ann Mason, 111  
 —, Octavius Augustus, 110  
 —, Peyton Randolph, 110  
 —, Richard Lucien, 111  
 —, Dr. Thomas S., 111  
 —, Walter, 111  
 —, William Byrd, 110, 111  
 Palmer, John Jervis, 109  
 Papineau, —, 129  
 Parker, Abel, 152  
 —, Alexander, 152  
 —, Anne, 152, 153  
 —, Arthur, 152  
 —, Daingerfield, 151, 153  
 —, Edward, 109  
 —, Elisabeth, 108, 109, 153  
 —, Foxhall, Alexander, 21,  
 151, 153  
 —, George, 108, 109, 151,  
 152  
 —, Sir Hy's, 139, 143  
 —, Jacob, 153  
 —, Janet, 108  
 —, John, 109, 119, 152, 153  
 —, John A., 153  
 —, John Henry, 153  
 —, Juliet, 153  
 Parker, Laetitia, 108  
 —, Martha, 107, 108  
 —, Mary, 109  
 —, Adm. Sir Peter, 137,  
 196  
 —, Richard, 151, 152  
 —, Richard Le Roy, 153  
 —, Robert, 109, 151  
 —, Robert Bogardus, 153  
 —, Robert Elliott, 153  
 —, Thomas, 108, 109, 152,  
 153  
 —, Upshur, 151  
 —, William, 108, 109  
 —, William Harwood, 5,  
 7, 16, 21, 69, 102,  
 133, 151, 152, 153  
 Pasley, —, 83  
 Patterson, Capt. Carlisle, 175,  
 180  
 —, Commodore D. J., 179  
 —, Commander Daniel  
 Tod, 175  
 —, Georgia Ann, 175, 180  
 Paul, Elisabeth, 114  
 —, George, 114  
 —, John, 114  
 —, Mary Ann, 114  
 —, William, 112, 114  
 Paulding, Anna, 155, 156  
 —, Caleb, 156  
 —, Caroline, 155, 156  
 —, Emma, 155, 156  
 —, George, 155, 156  
 —, Helen, 156  
 —, Hiram, 5, 7, 16, 21, 28,  
 30, 154, 155, 156  
 —, James, 156  
 —, John, 155, 156  
 —, John Ward, 156  
 —, Julia, 156  
 —, Leonard, 155, 156  
 —, Mary, 155, 156  
 —, Rebecca, 155, 156  
 —, Sarah Teed, 156  
 —, Susan, 156  
 —, Tattnal, 155, 156  
 —, Virginia, 156  
 Paullin, Admiral C., 170, 188,  
 189, 190, 191, 193  
 Peale, William Robert, 62  
 Pearson, Rev. William H., 128  
 Pelham, Penelope, 50  
 Pellew, Arthur Samuel, 159  
 —, Barrington Reynolds,  
 159  
 —, Caroline Emma, 159  
 —, Catherine, 159  
 —, Edward, 5, 6, 16, 30,  
 157, 158, 159  
 —, Emma Mary, 159  
 —, Fleetwood Boughton,  
 159  
 —, Fleetwood Hugo, 159  
 —, Fleetwood John, 159  
 —, George, 159  
 —, Rev. George Israel,  
 159  
 Pellew, Humphrey, 158  
 —, Sir Israel, 158  
 —, Jane, 159  
 —, John, 159  
 —, Julia, 159  
 —, Juliana, 159  
 —, Percy T., 159  
 —, Pownoll Bastard, 159  
 —, Pownoll Fleetwood, 159  
 —, Pownoll William, 159  
 —, Samuel, 158  
 Pepper, Dr. William, 169  
 Perceval, John, 154  
 Perkins, George Hamilton, 5,  
 6, 16, 21, 29, 160,  
 161, 162  
 —, Hamilton Eliot, 161,  
 162  
 —, Isabel, 162  
 —, M., 170  
 —, Roger, Eliot, 162  
 Perrin, Betsey, 73  
 —, Mary, 73  
 —, Pamela, 73  
 —, Polly, 73  
 —, Porter, 73  
 —, Samuel, 73  
 —, Sophia, 73  
 —, Truman, 73  
 —, William, 73  
 —, Zachariah, 73  
 Perrott, James, 166  
 Perry, Ann, 165  
 —, Anna, 169  
 —, Ann Maria, 167, 169  
 —, Benjamin, 168  
 —, Caroline Stidell, 169  
 —, Christopher Grant, 169  
 —, Christopher Raymond,  
 30, 165, 166, 168,  
 169, 170  
 —, Edward, 168  
 —, Elisabeth, 165, 168,  
 169  
 —, Francis Sergeant, 169  
 —, Freeman, 168  
 —, George Hasard, 168  
 —, Isabella, 169  
 —, James Alexander, 17,  
 168, 169  
 —, Jane, 168  
 —, Jane Hasard, 169  
 —, John, 169  
 —, John Edward, 167  
 —, Joshua, 168  
 —, Mary, 168  
 —, Matthew Calbraith,  
 5, 7, 16, 22, 30, 110,  
 151, 152, 153, 162,  
 163, 164, 166, 167,  
 169, 207  
 —, Nathaniel Hasen, 169  
 —, Oliver, 166, 167  
 —, Oliver Hasard, 5, 6, 17,  
 22, 29, 30, 53, 162,  
 163, 164, 165, 166,  
 168, 169, 170  
 —, Raymond, 169

- Perry, Raymond Henry James, 168  
 —, Rest, 168  
 —, Sarah, 169  
 —, Sarah Wallace, 169  
 —, Susan, 168, 169  
 —, Thomas Sergeant, 169  
 —, William, 169  
 —, William Ledyard, 169  
 Peter, King, 203  
 Petrie, William, 84, 85  
 —, William Matthew Flinders, 84, 85, 92  
 Phelps, Anna, 72  
 Phillip, Abigail, 205  
 —, Adm. Arthur, 5, 16, 173  
 —, Barrett, 173  
 —, George, 173  
 —, John G., 173  
 —, John Henry, 173  
 —, John Woodward, 5, 7, 16, 172  
 —, Woodrow, 173  
 Phillips, Richard, 215  
 Philips, Juliana, 75  
 Pierce, F., 206  
 Pike, Dorothy, 51  
 —, Timothy, 52  
 Pillsbury, Elsie, 62  
 —, Florence Greenwood, 62  
 —, John, 20  
 —, John Elliott, 20, 62, 63  
 —, John Gilmore, 62, 63  
 Pine, Anna, 69  
 Pinkney, Charles, 169  
 —, Edward Coate, 169  
 —, Frederick, 169  
 —, Ninian, 169  
 —, William, 169  
 Pitt, Thomas, 202  
 —, William, Earl Chatham, 202  
 Poer, Catherine de la, 43  
 de Ponte, Elisabeth, 186  
 Porden, Eleanor Anne, 92  
 Porter, Alexander, 179  
 —, Anne, 179  
 —, Bolton, 179  
 —, Capt. Carlisle, 29, 175, 180  
 —, David, 5, 6, 22, 29, 69, 79, 80, 177, 178, 179, 180  
 —, David Dixon, 5, 6, 16, 22, 29, 70, 79, 80, 123, 175, 176, 178, 179, 180, 189  
 —, David H., 179  
 —, Essex, 29, 175, 179, 180  
 —, Evalina, 179  
 —, Fits-John, 179  
 —, Hambleton, 180  
 —, Henry Ogden, 179  
 —, Imogen, 179  
 —, Commander John, 17, 22, 179  
 —, Mary, 179  
 Porter, Richard, 29, 175, 180  
 —, Samuel, 179  
 —, Theodoric, 29, 175, 180  
 —, Thomas, 180  
 —, William D., 179  
 Portugal, King of, 47  
 Potter, Harriet, 204  
 —, Harriet Maria, 206  
 —, John, 204  
 Powell-Leslie, Charles, 43  
 —, Christine, 48  
 Pownall, Stanislaus, 157  
 Pratt, Elisabeth, 110  
 —, William, 110  
 Pray, Mary, 100  
 Preble, Adeline, 184  
 —, Alice, 184  
 —, Eben, 182, 184  
 —, Ebenezer, 28, 182, 183  
 —, Edward, 5, 7, 16, 23, 28, 30, 134, 136, 181, 182, 183, 184  
 —, Edward Deering, 181, 183  
 —, Edward Henry, 184  
 —, Ellen Bangs, 184  
 —, Enoch, 28, 182, 183  
 —, Frances Amica, 184  
 —, Francis, 182  
 —, George Henry, 182, 184  
 —, Harriet, 184  
 —, Henry, 182, 183  
 —, Henry Ornard, 184  
 —, Jedediah, 182, 183  
 —, John, 183  
 —, Joshua, 28, 183  
 —, Lucy, 183  
 —, Martha, 182, 183  
 —, Mary, 184  
 —, Samuel, 183  
 —, Statira, 182, 183  
 —, William, 183  
 Prentiss, Annie, 90  
 —, John, 89  
 Prime, Nathaniel, 195  
 —, Rufus, 195  
 —, T., 195  
 Primrose, Elisabeth, 78  
 Quin, Lavina, 200  
 Radford, John, 186  
 Radstack, Lord, 141  
 Raikes, H., 50  
 Raleigh, Carew, 186, 187  
 —, George, 186  
 —, John, 186  
 —, Margaret, 186  
 —, Mary, 186  
 —, Walter, 5, 18, 185, 186, 187  
 Ray, Sybil, 194  
 Raymond, Elisabeth, 168  
 —, Joshua, 194  
 Read, Caroline Laurens, 124  
 Reed, David, 50  
 —, Franklin, 110  
 —, Lucy Franklin, 110  
 Remington, Mary, 206  
 Rennie, Elisabeth, 75  
 Reynolds, Elisabeth, 168  
 —, Thomas, 168  
 Rhett, Catherine, 213  
 —, Mary, 213  
 —, Sarah, 213  
 —, William, 22, 212, 213, 214  
 Rhinelander, John, 206  
 Rhodes, Mary, 100, 134  
 Rice, Edward, 128  
 —, Hon. George, 128  
 —, Henrietta, 128  
 —, Hon. Maria, 128  
 —, Sarah Parker, 73  
 Richards, G., 170  
 Richardson, Sir John, 102  
 Ricketta, Mary, 108  
 —, William Henry, 108  
 Ringgold, Dr. James, 136  
 Roberts, Capt. Francis, 93  
 —, Jack, 93  
 —, Joe, 93  
 Rochelle, J. N., 211  
 Rodgers, Alexander, 169  
 —, Alexander Perry, 169  
 —, Ann Minnie, 169, 190  
 —, Augustus Frederick, 169, 190  
 —, Christopher Randolph Perry, 30, 167, 169  
 —, Elisabeth, 169  
 —, Elisabeth Jacobs, 39  
 —, Frederica, 169  
 —, Frederick, 169, 170, 189, 190  
 —, George Washington, 19, 22, 30, 69, 162, 165, 169, 189, 191  
 —, Helen, 169  
 —, Henry, 169, 189  
 —, James, 39  
 —, Jane, 170  
 —, Jerusha, 169  
 —, Admiral John, 5, 7, 18, 22, 23, 26, 30, 62, 71, 72, 168, 169, 170, 187, 188, 189, 190, 203  
 —, John Augustus, 169, 170  
 —, John F., 169  
 —, Louise, 169  
 —, Mary, 169  
 —, Rebecca, 169  
 —, Robert, 169, 189  
 —, Sarah, 169  
 —, Thomas Reynolds, 169  
 —, Thomas Stidell, 169  
 —, William Pinkney, 169, 189  
 Rodney, Sir George, 74  
 —, George Bridges, 5, 18, 192, 196, 201  
 de Rohan, William, 8, 64, 67  
 Rokeby, Lord, 117  
 Rolle, Margaret, 116  
 Ross, Sir John Lockhart, 75



- Botch, William, 206  
 Rous, Augusta, 58  
 —, John E. Cornwallis, 58  
 Rowan, James, 66, 67, 175  
 —, Martha, 65, 67  
 —, Stephen Clegg, 66  
 Ruggles, Elisabeth, 45  
 Rupert, Prince, 47, 105  
 Ruperta, Princess, 105  
 Rush, Benjamin, 205  
 —, James, 206  
 —, Richard, 206  
 Russell, Alexander George, 117  
 —, Cosmo George, 117  
 —, Edward, 116  
 —, Francis, 116  
 —, Francis John, 116  
 —, George William, 116  
 —, Henry, 117  
 —, John, Duke of Bedford, 115  
 —, William, 116, 148  
 —, W. C., 60  
 —, Wriothley, 116  
 Rutherford, Daniel, 75  
 Ruthven, Anne, 78  
 —, James, Lord, 78  
 —, John, 78  
 Rylands, W., 109
- Sands, Comfort, 193, 194  
 —, Cornelia, 195  
 —, Elisa, 193, 195  
 —, Ferdinand, 193, 195  
 —, James, 194  
 —, John, 194  
 —, Joseph, 195  
 —, Joshua, 193  
 —, Adm. Joshua Ratoon, 5, 18, 164, 193, 194, 195  
 —, Louis Joseph, 193, 194, 195  
 —, Mercy, 194  
 —, Sarah, 194  
 Saumares, Amelia, 197  
 —, Anne, 197  
 —, Carteret, 197  
 —, Charlotte, 197  
 —, James, 5, 6, 18, 196, 197  
 —, John, 197  
 —, John de, 197  
 —, John St. Vincent, 197  
 —, John Thomas, 197  
 —, Martha, 197  
 —, Mary, 197  
 —, Matthew, 197  
 —, Nicholas, 197  
 —, Philip, 197  
 —, Richard, 197  
 —, Thomas, 197  
 Saxton, Mercy, 71, 72  
 Searth, Katharina M., 214  
 Scharf, J., 55, 111  
 Schley, Commodore, 172  
 Scott, E., 85  
 —, Gen. Winfield, 207
- Scott, Major Sylvanus, 99  
 —, Sir William, 105  
 Scrope, Anabella, 105  
 —, Lady Anabella, 105  
 —, Emanuel, Earl of Sunderland, 105  
 —, John, Earl of Rutland, 105  
 Scudder, Mary T., 3  
 Selden, Mary Mason, 110  
 Selkirk, Lord, 112, 114  
 Selwood, —, 92  
 Semmes, Benedict, 199  
 —, Oliver J., 199  
 —, Raphael, 5, 7, 18, 123, 197, 199  
 —, Richard Thompson, 199  
 —, Samuel Middleton, 199  
 —, Thomas Jenkins, 199  
 Sergeant, Frances, 169  
 Seymour, Albert, 201  
 —, Augusta, 201  
 —, Caroline, 200  
 —, David, 200  
 —, Sir Edward, 186, 201  
 —, Edward Hobart, 5, 7, 18, 23, 200, 201  
 —, Elizabeth, 200  
 —, Ellen, 200  
 —, Frances, 200  
 —, Henry, 201  
 —, Jane, 200  
 —, Rev. John, 200  
 —, John, 201  
 —, John Hobart, 201  
 —, John Hobart Culme, 200  
 —, Mary, 200  
 —, Michael, 23  
 —, Sir Michael, 200  
 —, Sir Michael Culme, 200, 201  
 —, Richard, 200  
 —, Richard Arthur, 201  
 —, Walter Richard, 201  
 —, William Hobart, 200  
 Shairp, Catherine, 130  
 —, Sir Stephen, 130  
 Shakespeare, William, 203  
 Shaler, Lucy Ann, 121  
 —, Nicholas, 121  
 Sherman, A., 150  
 —, Roger, 89  
 Shine, Elisabeth, 82  
 —, John, 82  
 Shippen, R., 153  
 Skeeler, Jane, 42  
 —, Rev. Thomas, 42  
 Skeffington, Admiral, 132  
 Skelton, James, 110  
 —, Sally, 110  
 —, Sarah, 146  
 Slidell, Jane, 169  
 —, John, 169  
 —, Julia, 169  
 Smith, Hon. Albert, 62, 63  
 —, Sir Albert Jones, 63
- Smith, Augusta, 66, 200  
 —, Lady Caroline Mary, 202  
 —, Charles, 200  
 —, Charles Douglass, 202  
 —, Sir Charles Joshua, 200  
 —, Cordelia Miller, 62  
 —, Capt. Cornelius, 202  
 —, Drummond, 200  
 —, Edward, 201, 202  
 —, Edward Herbert, 202  
 —, Elisabeth, 63, 128  
 —, Elisabeth Winkle, 20, 62, 63  
 —, Frances, 200  
 —, Gilbert Joshua, 201  
 —, Jane Read, 63  
 —, John, 200, 201, 202  
 —, John Spencer, 202  
 —, Joseph Bass, 62, 63  
 —, Josiah, 63  
 —, Lucy, 102  
 —, Margaret Sprague, 63  
 —, Maria Louisa, 200  
 —, Mary, 73  
 —, Mary Butler, 61, 62  
 —, Rev. Orlando, 201  
 —, Sarah Barker, 63  
 —, Seymour Spencer, 201  
 —, Spencer, 200  
 —, Rev. Thomas, 63  
 —, William A., 66, 67  
 —, W. B., 150  
 —, Sir William Rumbold, 202  
 —, W. Sidney, 5, 6, 18, 29, 201, 202  
 Smyth, W., 42  
 Snedde, Hugh, 186  
 Snell, Hannah, 28  
 Soley, J. R., 176, 177, 180  
 Somerby, H., 46  
 —, Capt. Joseph, 73  
 Southey, Robert, 140  
 Southwell, Catherine, 116  
 —, Sir Edward, 115, 116  
 —, Elisabeth, 116  
 —, Sophia, 116  
 Sparnon, Judith, 158  
 Spencer, Anne Elisabeth, 198, 199  
 —, Oliver Marlborough, 198, 199  
 Sprague, Margaret, 62  
 Spriddle, Lieutenant, 159  
 Stafford, John, 41  
 Stanforth, Margaret, 103  
 Stanley, Edward, 102  
 —, Lord James, 102  
 Stanley, Lucy, 102  
 Stapleton, Catherine, 95  
 —, Robert, 95  
 St. Clair, General, 120, 121  
 —, Col. de, 202  
 Stebling, V., 187  
 Stephenson, Augustus, 117  
 —, Elisabeth, 38

Stephenson, Henry, 116  
 —, Sussex, 117  
 Stewart, Col. Wm., 141  
 Stirling, K., 117  
 Stockton, Abigail, 205, 206  
 —, Annis, 206  
 —, Caroline, 206  
 —, Catherine Elisabeth,  
 206  
 —, Charles, 206  
 —, Charles C., 206  
 —, Edward, 206  
 —, Harriet M., 206  
 —, Howard, 206  
 —, John, 204, 205  
 —, John Potter, 206  
 —, Lucius, 206  
 —, Lucius Horatio, 205  
 —, Lucius W., 206  
 —, Mary, 206  
 —, Mary Elisabeth, 206  
 —, Rev. Philip, 205  
 —, Philip Augustus, 206  
 —, Rebecca, 206  
 —, Richard, 204, 205, 206  
 —, Robert Field, 5, 6, 18,  
 22, 29, 203, 204,  
 206  
 —, Samuel, 206  
 —, Samuel Witham, 205,  
 206  
 —, Susan, 205  
 —, T. C., 205  
 Stopford, Sir Robert, 100, 102  
 Stout, Lucy, 119  
 Street, Caroline, 90  
 —, Mary, 89  
 Strickland, Margaret, 57  
 Strong, Martha, 108  
 Stuart, Anne, 78  
 Stuart, Charles, 128  
 Stuart, Jane, 57  
 Sturgis, Mrs. E., 46  
 Sturman, —, 152  
 Sturman, Mary, 153  
 St. Vincent, Earl of, 81  
 Suckling, Anna Maria, 147  
 —, Catherine, 146  
 —, Rev. John, 147  
 —, Maurice, 2, 20,<sup>1</sup> 137,  
 144, 146, 147  
 —, Richard, 146  
 —, Robert, 146, 147  
 —, Robert George, 147  
 —, William, 146, 147  
 —, William Benjamin, 146,  
 147  
 Sullivan, Felix, 55  
 —, Felix R., 55  
 —, Franklyn Buchanan,  
 53, 55  
 —, Mary, 55  
 —, Nannie, 55  
 —, Rev. Thomas B., 46  
 Sutton, Elisabeth, 128  
 Swynfen, John, 108  
 —, Mabella, 108  
 —, Mary, 108

Symonds, Margaret, 48  
 Talbot, Baron, 128  
 —, Commander, 136  
 —, Charles John, 44  
 —, Mary Anne, 28  
 —, Sir Reginald, 44  
 —, William, Earl, 128  
 Talcott, Elisur, 72  
 —, George, 72  
 —, Hannah, 73  
 —, Mary, 73  
 —, Nehemiah, 73  
 —, Samuel, 72, 73  
 —, S. V., 73  
 Tallman, Martha, 118  
 Tarbox, Betsey, 78  
 Tarleton, Sir Banastre, 188  
 Tart, William, 75  
 Tattnall, Edward Fenwick, 210  
 —, John, 210  
 —, Josiah, 5, 18, 23, 109,  
 207, 208, 209, 210  
 Taylor, Alexina, 111  
 —, Gen., 151  
 —, Harriet, 169  
 —, Jane, 170  
 —, John, 37  
 —, Col. Joseph, 169  
 —, Montgomery Meigs,  
 170  
 Teackle, —, 153  
 Ten Eyck, Commissioner, 204  
 Tenney, S., 52  
 Tennyson, Lord Alfred, 92  
 Thompson, B., 195  
 Thompson, Hon. John Ren-  
 shaw, 206  
 Thrale, Hester Maria, 78  
 Tiffany, George, 169  
 Todd, Rev. A., 90  
 Toppan, Hannah, 150  
 Townsend, John Thomas, 116  
 Traill, H., 92  
 Trelawny, Sir John, 20, 96, 97  
 —, June, 97  
 —, Roger, 97  
 Trench, Lady Elisabeth, 132  
 Trenchard, Edward, 193, 195  
 —, George, 194  
 —, James, 194  
 —, Stephen D., 193, 194,  
 195  
 Tromp, Cornelius Van, 211  
 —, Martin Harperts, 5, 6,  
 18, 29, 47, 210  
 Trott, Mary, 213  
 —, Nicholas, 213  
 Trotter, Sir Coutts, 116  
 —, Susan, 116  
 Troubridge, John, 140  
 Truxton, —, 188  
 Tuberville, John, 110  
 —, Lettice Corbin, 110  
 Tucker, Edgar, 184  
 —, John, 109, 124, 211  
 —, John Randolph, 5, 7,  
 18, 211

Tufton, Catherine, 115  
 —, Lady Margaret, 115  
 Turner, Anne, 146  
 —, Sir Charles, 146  
 Turton, Elisabeth, 108  
 —, John, 108  
 —, Sir John, 109  
 —, Margaret, 108  
 Tuttle, C., 187  
 —, Mary, 156  
 Twistleton, Hon. Cassandra,  
 109  
 Tyler, President John, 204  
 Tyndall, Proncy, 73  
 Upahur, Abel Parker, 152, 153,  
 204  
 —, George Parker, 152,  
 153  
 —, Littleton, 152, 153  
 Usher, S., 121  
 Vance, John, 121  
 —, Mary, 121  
 —, Samuel, 21, 121  
 Vandergrift, L., 121  
 Vane, Lady Francis, 106  
 VanWyck, Anne Stedman, 39  
 Victoria, Queen, 116, 193  
 Vinton, Abiathar, 67  
 —, Rev. Francis, 169  
 —, Hon. Samuel F., 67  
 Waddy, Isaac, 39  
 Wade, Annie McKean, 55  
 —, Col. Richard, 55  
 —, Robert Buchanan, 55  
 Walker, Sarah, 194  
 —, Gen. William, 149, 154,  
 193  
 Wallace, Alexander, 168  
 —, Charles, 168  
 —, James, 168  
 —, James (Lord Dun-  
 donald), 168  
 —, Sir Richard, 168  
 —, Robert, 168  
 —, Sarah Alexander, 168  
 —, William, 168  
 —, William Bailey, 168  
 Waller, Sir Jonathan, 105  
 Walling, R., 98  
 Walpole, Galfridus, 20, 146  
 —, Harriet, 103  
 —, Horatio, 103, 146  
 —, Maria, 116  
 —, Mary, 146  
 —, Robert, 116, 146  
 —, Sir Robert, 20, 146  
 —, S., 117  
 Ward, Rear-Admiral Aaron, 71  
 —, Abigail, 155  
 —, Benjamin, 155  
 —, Caleb, 155  
 —, Esther, 155  
 —, Capt. James 214  
 —, John, 21, 155  
 —, Mary, 156

## NAMES OF PLACES.

Ward, Nelson, 144  
 —, Philip, 144, 147  
 —, Phoebe, 156  
 —, Samuel, 98  
 —, Susanna, 84, 85  
 Washington, George, 40, 51, 53,  
 104  
 —, Jane, 213  
 Watson, Lieut. Arthur, 136  
 —, Catherine, 115  
 —, Edward, 115  
 —, Elisabeth, 54, 74  
 —, Marmaduke, 54  
 —, Mary, 200  
 —, Richard, 200  
 Wattles, Sophia, 182, 183  
 Watts, Francis Holland, 38  
 Webb, Jonathan, 183  
 —, Susanna, 147  
 Webster, Daniel, 88  
 Weld, Anna M., 160  
 —, Isabella, 106  
 Wellesey, Sir Arthur, 77  
 Wellington, Duke of, 1  
 West, Rt. Hon. Sir Algernon,  
 116  
 —, A., 117  
 —, Jane Elisabeth, 116  
 —, Gilbert, 117  
 —, Martin J., 116  
 Westcott, Damaris, 168  
 Wharton, Lucy, 67  
 Whinyates, Edward, 213  
 —, Francis, 213  
 —, Frederick, 213  
 —, Sir Thos., 213  
 Whipple, Abigail, 99

Whitbreak, Juliana, 117  
 Whitehall, Anne, 108  
 Whittle, Captain, 111  
 Whittlesley, Henry, 90  
 Wickenden, Rev. William, 99  
 —, Plain, 99  
 Wilkes, Charles, 134, 167  
 Wilkinson, Benjamin, 100, 137  
 —, I, 100  
 —, John, 99  
 —, Joseph, 100  
 —, Lydia, 134  
 —, Mary, 202  
 —, Pinkney, 202  
 —, Ruth, 99  
 —, Samuel, 99  
 —, Susanna, 100  
 —, William, 99  
 William, King I, 115  
 William IV, 60  
 Williams, Catherine, 205  
 —, Humphrey, 48  
 —, Sarah, 48  
 Wilson, Hugh, 184  
 Winckly, John, 101  
 —, Margaret, 102  
 Winniett, Alexander, 215  
 —, Anne, 215  
 Winslow, Benjamin, 212, 213  
 —, Catherine A., 212, 214  
 —, Chilton R., 214  
 —, Eben E., 212, 214  
 —, Edward, 212, 213  
 —, Edward D., 214  
 —, Frances A., 214  
 —, Herbert, 212, 214  
 —, James H., 214

Winslow, John A., 5, 7, 18,  
 22, 29, 212, 214  
 —, Mary C., 214  
 —, William R., 214  
 Winston, John, Duke of Marl-  
 borough, 106  
 Winthrop, Marianne, 159  
 Wirt, William, 152  
 Wodehouse, Anna, 146  
 Wolsey, Cosby W., 215  
 —, Elisabeth, 215  
 —, Field Marshal, 214  
 —, Garnet T., 215  
 —, John H., 215  
 —, Mary T., 215  
 —, Robert, 215  
 —, Capt. Richard, 214, 215  
 —, Sydney A., 215  
 —, W., 5, 6, 18, 23, 29,  
 42, 214, 215  
 —, W. N., 19, 214, 215  
 Wood, Marianne, 129  
 Woodbury, Eliphalet, 52  
 Woodward, E., 55  
 —, Frances, 147  
 —, Dr. Theodore, 173  
 Wootton, —, 156  
 Worth, R. N., 98  
 Wright, Canon, 92  
 —, Frances, 182, 183  
 —, Sir James, 213  
 —, Rev. Richard, 92, 213  
 —, Robert, 213  
 —, Sarah, 213  
 Wrottesley, G., 102  
 Yeomans, Prudence, 73

## NAMES OF PLACES.

Abercorn, 106  
 Aboukir, Egypt, 77  
 Aboukir Bay, 138  
 Accomac County, Va., 151, 152  
 Acre, Syria, 58, 100  
 Adelaide, Aus., 84  
 Adriatic Sea, 103  
 Agincourt, 20  
 Agra, 98  
 Alabama, 73, 212  
 Albany, N. Y., 73, 90, 96, 111,  
 180  
 Albemarle, 115, 116, 117  
 Albemarle Sound, 60  
 Aldershot, Eng., 106  
 Alexandria, Egypt, 42, 77, 103  
 Alexandria, Va., 182, 203, 211  
 Algeciras, 196  
 Algiers, 20, 21, 62, 69, 79, 116,  
 133, 158, 167, 183, 203, 215  
 Alps, 70  
 Alvarado, 193  
 Amazon River, 211

Amboy, 204, 206  
 Annapolis, Md., 39, 44, 46, 51,  
 52, 53, 70, 73, 86, 111, 134,  
 136, 151, 153, 155, 156, 160  
 Annapolis Royal, Nova Scotia,  
 214, 215  
 Annsfield, Lanarkshire, Eng.,  
 56  
 Antigua, 138, 205  
 Argentine, 61  
 Argyle, Scotland, 56  
 Arizona, 61  
 Armagh, Ireland, 132  
 Assaye, 77  
 Australia, 83, 84, 85, 91, 145,  
 147, 174  
 Austria, 22  
 Azores, 185  
 Badajos, Spain, 214  
 Bahamas, 212  
 Balearic Islands, 111  
 Ballston Spa, 62

Baltic Sea, 93, 197  
 Baltimore, Md., 26, 37, 38, 39,  
 53, 54, 55, 156, 187, 190,  
 193, 203  
 Bantry Bay, 96  
 Barbadoes, 15, 100, 105  
 Barbary States, 36, 68, 88, 178,  
 181, 193, 211  
 Barcelona, 81  
 Barfleur, Cape, 43  
 Barnstable, 201  
 Bass Strait, 83  
 Bastia, Corsica, 138  
 Batavia, 41  
 Beaufort, N. C., 193  
 Bedford, 115, 116  
 Beechey Island, 91  
 Behring Strait, 191  
 Belle Isle, 67, 68  
 Bengal, India, 78  
 Bennington, Vt., 72  
 Bergen-Op-Zoom, 115  
 Berlin, 116

Bermuda, 19, 211  
 Berne, Switzerland, 202  
 Bladensburg, Md., 207  
 Block Island, 194  
 Bombay, 78, 145  
 Bonaventure, Ga., 207  
 Boston, Eng., 21, 130  
 Boston, Mass., 15, 39, 44, 58, 61, 62, 68, 70, 83, 89, 90, 95, 96, 104, 108, 121, 130, 134, 148, 155, 160, 161, 170, 172, 177, 183, 184, 187, 192, 197, 199, 203, 207, 212  
 Bosworth Field, 186  
 Botany Bay, 83, 174  
 Boulogne, 41  
 Bowdoin, 149, 182  
 Brazil, 20, 47, 56, 191  
 Brest, 59, 76, 77, 83, 112, 127, 196, 197  
 Brewster, Mass., 183  
 Bridgewater, Eng., 47, 48  
 Bristol, R. I., 168  
 British New Guinea, 133  
 Brooklyn, N. Y., 87, 154, 162, 167, 172, 173, 193  
 Browholme, 108  
 Bucks County, Pa., 66  
 Bucks, Eng., 116  
 Buenos Ayres, 134  
 Bundelkhand, India, 92  
 Burlington, N. J., 54, 55, 118, 119, 205  
 Burnham Thorpe, County of Norfolk, Eng., 137  
 Bury, 102  
  
 Cadiz, Spain, 51, 59, 156, 185, 196  
 Cairo, Egypt, 77  
 Cairo, Ill., 212  
 Calcutta, India, 133  
 California, 34, 111, 190, 204  
 Callao, 204  
 Cambridge, 103, 144, 146, 148  
 Cambridge, Eng., 125  
 Cambridgeshire, Eng., 145  
 Camden, N. J., 204, 206  
 Camelford, 202  
 Campbell's Station, Tenn., 79  
 Canada, 74, 91, 116, 117, 118, 119, 127, 129, 141, 206  
 Canterbury, Eng., 145  
 Canton, China, 84, 87, 159, 200  
 Canton River, 88, 200  
 Cape Breton, 192  
 Cape Fear River, 122  
 Cape of Good Hope, 41, 53, 74, 75, 77, 84, 100, 116  
 Cape Hatteras, 193  
 Cape Horn, 53  
 Cape Leeuwin, 83  
 Cape Mesurado, Africa, 203  
 Cape St. Vincent, 59, 74, 193, 201  
 Cape Tiburon, 165  
 Cape Town, Africa, 76

Cape Verde Islands, 44  
 Capri, 201  
 Cardigan, 105  
 Carolina, 117  
 Caroline Islands, 200  
 Carsethorne, Scotland, 113  
 Carthage, 27  
 Carthagenia, 47  
 Castleton, Vt., 173  
 Ceylon, 147, 214  
 Chancellorsville, 66  
 Chapultepec, 165, 169  
 Charles Co., Md., 198  
 Charleston, S. C., 66, 76, 127, 196, 204, 206, 211, 212  
 Chatham, 42  
 Chelmsford, 97  
 Chelsea, Eng., 49, 116  
 Chenies, Eng., 116  
 Cherbourg, 197, 212  
 Chesapeake Bay, 37, 134, 201  
 Cheshire, Conn., 88, 89, 90  
 Chester, Pa., 54, 175, 177, 180  
 Chicago, Ill., 20, 61, 62, 206  
 Chile, 65, 191, 211  
 China, 42, 98, 100, 109, 117, 125, 191, 200, 208, 212  
 China Sea, 114  
 Chippewa, 110  
 Cincinnati, O., 199  
 Clarke Co., Va., 109  
 Cleveland, O., 170, 190  
 Colorado Springs, 67  
 Columbia Co., N. Y., 173  
 Columbus, O., 20, 62  
 Concord, N. H., 161  
 Coningsby, Lincolnshire, Eng., 92  
 Connecticut, 23, 88, 89  
 Constantinople, 100, 178, 179, 201, 202  
 Contreras, 136  
 Copenhagen, 20, 91, 93, 139, 141, 143  
 Corsica, 143  
 Cortland, West Chester Co., N. Y., 154  
 Coshan, 133  
 County Tyrone, 145  
 Cowes, Eng., 209  
 Craney Islands, 207  
 Cristophe, 187, 189  
 Cuba, 27, 137, 172, 206, 208, 209  
 Culloden, 115  
 Cumberland, Md., 88, 199  
 Curacao Islands, 194  
  
 Dacca, 159  
 David's Island, 111  
 Deans Yard, Eng., 127  
 Delafield, Waukesha Co., Wis., 60  
 Delaware, 21, 39, 53, 54, 55, 121, 168, 180, 204  
 Denmark, 139  
 Derby, Conn., 81, 102  
 Derbyshire, 117

Des Moines, 55  
 Detroit, 90  
 Devon, Eng., 19, 98, 185, 186  
 Devonshire, Eng., 185  
 Dinwiddie Court House, Va., 136  
 Dogger Bank, 196  
 Dorchester, Mass., 46  
 Dorset, Eng., 93  
 Dover, Eng., 17, 47, 156, 158, 201  
 Down Co., Ireland, 215  
 Downes, Eng., 210  
 Drury's Bluff, 211  
 Dry Tortugas, 207  
 Dublin, Ire., 66, 123, 124, 132, 168  
 Dumfries, 114  
 Dundalk, Ire., 132  
 Dundas, 75  
 Dundee, Farfarshire, Scotland, 74, 75  
 Dunkerque, 210  
 Dutch West Indies, 51  
  
 East Indies, 42, 74, 76, 86, 87, 92, 98, 128, 137, 147, 200, 214  
 Edinburgh, Scotland, 76, 77, 110  
 Egypt, 41, 77, 138, 201  
 Elba, 138  
 Elisabeth City, 151  
 Encaster, 146  
 England, 20, 21, 23, 25, 27, 40, 41, 46, 47, 49, 50, 65, 72, 73, 76, 77, 83, 84, 91, 93, 95, 97, 98, 99, 100, 104, 112, 115, 116, 117, 123, 129, 134, 136, 137, 138, 139, 140, 142, 143, 145, 148, 158, 168, 174, 185, 189, 192, 194, 196, 197, 198, 201, 202, 203, 206, 207, 208, 209, 210, 211  
 English Channel, 95, 100, 104, 107, 142, 148, 183  
 Erie, Pa., 61  
 Exeter, 116  
 Exmouth, Eng., 185, 186  
  
 Falkland Islands, 42, 133  
 Falmouth, Me., 158, 181, 183  
 Fataban, China, 114  
 Fayetteville, N. C., 124  
 Fife, Scotland, 78  
 Finland, 65  
 Flatbush, N. Y., 154  
 Florida, N. Y., 136  
 Flushing, N. Y., 8  
 Fontenoy, 115  
 Fort Charles, Jamaica, 202  
 Fort Columbus, 87  
 Fort Donelson, 87, 155  
 Fort Fisher, 61, 66, 70, 152, 155, 175, 182  
 Fort Henry, 87, 111  
 Fort Jackson, 46, 79, 80, 84

- Fort Pickens, Fla., 175  
 Fort Powell, 160  
 Fort San Juan, 137  
 Fort St. Philip, 46, 71, 79, 80, 175  
 Fort Sumter, 190, 211  
 Fortress Monroe, 154  
 France, 21, 25, 40, 51, 59, 64, 68, 69, 77, 91, 95, 107, 112, 113, 126, 134, 136, 137, 157, 158, 160, 182, 183, 186, 202  
 Frankfurt, Germany, 174  
 Fredonia, 62  
 Friendly Isles, 174  
  
 Gallinas, 193  
 Galveston, Texas, 81  
 Gefle, Sweden, 65  
 Geneva, 116  
 Genoa, 41, 186  
 Georgia, 19, 89, 111, 208, 209, 210, 213  
 Georgetown, D. C., 38, 199  
 Germantown, 152  
 Gettysburg, 66, 151, 153, 156  
 Gibraltar, 37, 38, 103, 104, 106, 107, 191, 198, 203, 210  
 Gilling, 95  
 Glastonbury, Conn., 72  
 Gleneagles Co., Perth, Scotland, 74  
 Gloucester, Eng., 200  
 Gloucester, Mass., 115, 123, 193  
 Grand Lake, La., 199  
 Great Barrier Reef, 84  
 Great Britain, 50, 102, 117  
 Great Lakes, 164  
 Greece, 66  
 Greenland, 91  
 Greenwich, Eng., 78, 93, 94, 108, 174, 192  
 Greytown, 134  
 Guernsey Islands, 196, 197  
 Guiana, 19, 164, 185, 187  
 Guinea, 96  
  
 Haddington, 128, 129  
 Hague, 125  
 Halifax, Nova Scotia, 50, 51, 148, 208  
 Hampton Roads, 53, 62, 63, 151, 193, 207, 211  
 Hants, Eng., 115  
 Harford Co., Md., 187  
 Harper's Ferry, 66  
 Harrow, Eng., 192  
 Hartford, Conn., 136, 170  
 Hatteras Inlet, N. C., 152  
 Havana, 21, 82, 104, 115, 136, 165, 172, 175, 208  
 Havre, France, 201  
 Havre de Grace, 26, 189  
 Hawaii, 204  
 Hesse, 15  
 Hilborough, Norfolk, 146  
 Hilton Head, S. C., 193  
 Hobart Town, 91  
  
 Hochkirch, 77  
 Holland, 25, 36, 37, 56, 103, 115, 162, 168  
 Hong Kong, 70, 169  
 Honolulu, 86, 135, 204  
 Hopkinton, Merrimack Co., 160  
 Hudson Bay, 91, 153  
 Huggate, County York, 197  
 Huntington, Long Island, 154  
  
 India, 44, 76, 77, 92, 106, 109, 114, 116, 127, 129, 136, 142, 143, 145, 168, 202  
 Indian Ocean, 158, 199  
 Ingoldthorpe, 103  
 Ireland, 42, 43, 102, 106, 116, 117, 121, 126, 128, 131, 132, 158, 168, 185, 186  
 Island Number 10, 87  
 Italy, 64, 103, 138, 182  
  
 Jackson, Miss., 71  
 Jacksonville, Fla., 100  
 Jalapa, 199  
 Jamaica, W. I., 39, 83, 90, 112, 127, 137, 192, 214  
 James River, 198, 211  
 Japan, 53, 125, 162, 166  
 Java, 9  
 Jersey, Island of, 197  
 Johnson, Vt., 70  
  
 Kansas City, 39  
 Kennebec, 187  
 Kent Island, 158  
 Kentucky, 38  
 Khartoum, 106  
 Kilkenny Co., Ireland, 215  
 Kincardine-on-Forth, 77  
 Kinderhook, Columbia Co., N. Y., 172  
 King George's Sound, 83  
 Kingston, Jamaica, 126  
 Kingston, R. I., 23  
 Kinsdale, Iceland, 47  
 Kirkbean, Kirkcudbright, Scotland, 112  
 Kirkee, 77  
 Kittery, Me., 148, 181, 183  
 Knoxville, 79  
 Knysna, Africa, 49  
 Korea, 191  
  
 La Guayra, 104, 201  
 Laguna, 193  
 Lake Champlain, 46, 62, 120, 154, 157  
 Lake Erie, 110, 163, 164, 165, 170  
 Lake George, 135  
 Lake Ontario, 193  
 Lake Pontchartrain, 82  
 Leeward Islands, 192, 201  
 Leghorn, 211  
 Leicester Co., Eng., 106, 115, 116, 117  
 Leith, Scotland, 113  
  
 Lewkner, Eng., 41  
 Lexington, Mass., 73, 148  
 Liberia, 87, 162, 203  
 Lichfield, 133  
 Lincoln, 116  
 Lincoln's Inn, 95  
 Lissa, 102  
 Liverpool, 25, 37, 136, 188  
 London, Eng., 44, 48, 50, 58, 60, 76, 84, 85, 89, 92, 94, 96, 98, 99, 101, 102, 103, 104, 105, 106, 109, 111, 117, 119, 139, 132, 133, 140, 145, 147, 148, 159, 174, 185, 187, 197, 201, 202, 210, 211  
 Long Island, N. Y., 64, 88, 149, 178  
 Longwood, Mass., 44  
 Los Angeles, 204  
 Louisburg, 21, 150, 192  
 Louisiana, 34, 81, 82, 199  
 Lucknow, India, 214  
  
 Machias, Me., 148, 150  
 Mackenzie River, 91  
 Madras, Spain, 13, 30, 31, 76, 78, 91, 92, 159  
 Magellan Strait, 98  
 Mahratta, 77  
 Maine, 34, 134, 148, 149, 183, 184, 187  
 Majorca, Balearic Isles, 82  
 Malaga, 133  
 Malta, 201  
 Manila, 70, 71, 136  
 Mansfield, Conn., 138  
 Mansfield, Eng., 57  
 Marblehead, Mass., 26  
 Mare Island, Cal., 79  
 Marquesas Islands, 27, 177  
 Marseilles, France, 157  
 Marston Moor, 108  
 Martinique, 138, 193  
 Maryland, 10, 53, 54, 58, 95, 168, 169, 198, 199  
 Massachusetts, 23, 136, 179, 181, 184  
 Mauritius, 41, 84, 114  
 Mediterranean Sea, 23, 41, 42, 47, 54, 55, 59, 61, 68, 69, 76, 79, 86, 91, 97, 107, 120, 127, 129, 136, 137, 138, 141, 146, 151, 157, 160, 162, 163, 175, 187, 188, 198, 200, 201, 204, 207, 208, 211  
 Medway River, 137  
 Melanisia, 133  
 Melville Islands, 131  
 Mercer County, 55  
 Meriden, 90  
 Merrimack, Mass., 21, 162  
 Mexico, 42, 64, 66, 79, 110, 111, 169, 172, 175, 179, 198, 199, 204  
 Mexico Gulf, 134, 136, 137, 207

Michigan, 73  
 Milwaukee, 90  
 Minnesota, 34  
 Minorca, Balearic Isles, 82  
 Mississippi, 23, 79, 81, 100,  
 103, 175, 198, 206  
 Missouri, 54, 55  
 Mobile, 53, 79, 123, 198, 199  
 Mobile Bay, 81, 111, 160, 161,  
 182, 184  
 Modbury, Eng., 186  
 Monmouth Co., N. J., 37  
 Monterey, Cal., 204  
 Montevideo, 131  
 Montpelier, Vt., 70, 73  
 Montreal, Quebec, 63  
 Morocco, 181, 187, 190  
 Moccow, 116  
 Mount Washington, 183  
  
 Nagasaki, Japan, 166  
 Naples, 49, 76, 93, 127, 138,  
 141, 142, 162, 201  
 Naseby, 108  
 Nashville, Tenn., 123  
 Nassau, 122  
 Nebraska, 111  
 Nevis, West Indies, 141  
 New Brunswick, N. J., 21, 53,  
 155, 197, 204  
 Newbury, 52  
 Newburyport, Mass., 10, 51,  
 148  
 New Castle Co., Del., 21, 120,  
 121  
 Newcastle-on-Tyne, 59  
 New England, 49, 72, 98, 99,  
 123, 168, 187, 207  
 Newfoundland, 127, 192  
 New Guinea, 133  
 New Hampshire, 73, 135, 149,  
 160, 162  
 New Haven, Conn., 86, 90  
 New Jersey, 23, 99, 118, 204,  
 205, 206, 215  
 New London, Conn., 40, 45,  
 73, 90  
 New Orleans, La., 79, 81, 82,  
 118, 160, 161, 175, 177,  
 179, 184, 198  
 Newport, Rhode Island, 44, 99,  
 100, 104, 125, 162, 163,  
 164, 168  
 New Providence, B. W. I., 98,  
 112  
 New River, 60  
 New South Wales, 174  
 Newton, Long Island, 121  
 New York, 25, 37, 39, 46, 51,  
 52, 54, 60, 65, 67, 68, 69,  
 73, 79, 83, 86, 90, 92, 98,  
 104, 111, 114, 117, 119,  
 121, 124, 125, 126, 130,  
 134, 136, 148, 149, 151,  
 153, 154, 155, 156, 162,  
 168, 170, 173, 174, 175,  
 180, 181, 188, 189, 193,  
 194, 195, 199, 206, 211, 215

Nicaragua, 137, 143, 154, 193,  
 206  
 Nice, 76  
 Nigeria, 131  
 Nile river, 20, 26, 103, 107,  
 114, 132, 139, 141, 193,  
 196  
 Nith river, 113  
 Norfolk, Va., 66, 79, 82, 109,  
 110, 111, 117, 126, 129,  
 146, 152, 154, 193, 208,  
 211  
 Norrkoping, Sweden, 65, 67  
 Northampton, Mass., 46  
 Northbeck, 108, 109  
 North Carolina, 34, 60, 66,  
 82, 110, 111, 213  
 North Creek, 116  
 Northeast Passage, 186  
 North Sea, 188  
 Northumberland Co., 110  
 Northwest Passage, 91  
 Norwich, Conn., 73, 168, 170  
 Norwich, Eng., 116, 154, 159  
 Nova Scotia, 19, 23, 134, 214,  
 215  
  
 Ohio, 62, 67  
 Orford, 116, 141  
 Oriel, Eng., 42  
 Orinoco river, 135  
 Otsego, N. Y., 136  
 Oxford, Eng., 47, 92, 101, 125,  
 126, 185, 187, 201  
 Oxford, N. Y., 168  
  
 Padua, 47  
 Palace, Limerick Co., 200  
 Palermo, 139, 182  
 Panama, 151, 160, 175  
 Paraguay, 160  
 Paris, France, 112, 113, 115,  
 117, 141, 162, 182, 184, 185  
 Pascagoula, 82  
 Pawcatuck river, 166  
 Peekskill, N. Y., 155  
 Peiho river, 208, 209  
 Peking, China, 200, 208  
 Pembroke, Mass., 63  
 Pennsylvania, 53, 54, 99, 206  
 Penobscot, 134, 181  
 Pensacola, Fla., 46, 83, 175  
 Perdido River, 198  
 Persia, 116  
 Perth Amboy, N. J., 53  
 Peru, 211  
 Petersburg, Va., 211  
 Philadelphia, Pa., 36, 37, 38,  
 40, 41, 54, 55, 64, 65, 66,  
 67, 69, 70, 86, 88, 90, 104,  
 111, 154, 156, 204, 205, 206  
 Pittsburgh, Pa., 37, 38, 70, 126  
 Plymouth, Eng., 37, 157, 158,  
 200  
 Plymouth, Mass., 62, 63, 76,  
 83, 148  
 Point Judith, 164  
 Poona, 77

Port Elisabeth, Africa, 133  
 Port Hacking, 83  
 Port Hudson, Miss., 79, 80, 83  
 Port Isabel, 151  
 Port Jackson, New South  
 Wales, 83, 160, 175  
 Portland, Me., 148, 182, 184  
 Port Moresby, 133  
 Porto Rico, 178  
 Port Philips, 160  
 Port Royal, 132, 208  
 Portsmouth, Eng., 114, 115,  
 186, 200  
 Portsmouth, N. H., 79, 132,  
 133, 134, 150  
 Port Sydney, 84  
 Portugal, 25, 102, 174, 201  
 Potomac River, 134  
 Pretoria, 76  
 Prince Edward Islands, 202  
 Princeton, N. J., 36, 37, 66, 68,  
 73, 162, 203, 204, 205, 206  
 Providence, R. I., 49, 90, 98, 99,  
 100, 136, 168  
 Prussia, 77  
 Puerte Plata, 88  
  
 Quebec, 107, 137  
 Queenstown, 135, 136  
 Quiberon, 96, 104, 116  
  
 Rangoon, 130  
 Raritan, N. J., 118, 204  
 Red River, 79  
 Red Sea, 133  
 Rhode Island, 49, 51, 69, 98,  
 99, 100, 166, 168  
 Richmond, Va., 111, 115, 153,  
 198, 211  
 Rio de Janeiro, 136, 200, 201,  
 215  
 Riviera, 138  
 Roanoke River, 60, 185, 193  
 Rochester, Stafford Co., 70, 83  
 Rome, 23, 65, 66, 67, 204, 206  
 Roxbury, Mass., 71, 90, 135, 136  
 Russia, 22, 55, 77, 78, 112, 113,  
 130, 139, 201  
 Rutland, 90  
  
 Sackett's Harbor, 136  
 Sag Harbor, 26  
 Saldanha Bay, 76  
 Salem, 26  
 Salisbury, Mass., 51  
 San Domingo, 90, 127, 128,  
 165, 187, 189  
 Sandy Hook, 136, 162, 177  
 Sands Point, 193, 194  
 San Francisco, Cal., 79, 111,  
 151, 155, 204  
 San Juan, 100, 143, 175  
 San Mateo Bay, 97  
 San Pedro, 204  
 Santa Cruz, 193  
 Santiago, 170, 173, 212  
 Saratoga, N. Y., 72, 101, 102,  
 168, 169

## NAMES OF VESSELS.

Savannah, Ga., 51, 53, 55, 207, 208, 210  
 Scarboro, Me., 148, 150  
 Scituate, R. I., 98, 135, 136  
 Scotland, 23, 54, 71, 75, 77, 78, 112, 117, 146, 168  
 Sebastopol, 114, 159  
 Seychelles Islands, 41  
 Sicily, 201  
 Sidmouth, Eng., 185  
 Sierra Leone, 41, 106, 214  
 Sinepuxent, Worcester Co., Md., 68  
 Sligo, 106  
 Southampton, Eng., 154  
 South Carolina, 73, 152, 168, 199, 206, 208, 210, 212, 213  
 South Kingston, R. I., 163  
 Spain, 8, 20, 25, 27, 56, 57, 65, 70, 78, 97, 98, 107, 125, 140, 149, 153, 170, 174, 175, 191, 192, 202, 209, 211  
 Spencer Gulf, 84  
 Spilsby, Lincolnshire, Eng., 91  
 Springfield, Mass., 39  
 Stafford Co., Eng., 108  
 Staffordshire, Eng., 107, 109  
 Staten Island, 26  
 St. Bartholomew, 208  
 St. Eustatius, W. I., 37  
 Stirling, Scotland, 46  
 St. George's Bay, 41  
 St. Helena, 133  
 St. Jean d'Acre, 201  
 St. Johns, Newfoundland, 183, 185  
 St. Lucia, 140, 192  
 St. Louis, 90  
 St. Mary's Isle, 112, 114  
 St. Nevins Island, 139  
 Stockholm, 65, 67, 202  
 Stonington, Conn., 72, 73  
 St. Paul, Minn., 68  
 St. Petersburg, 202  
 St. Thomas Island, 36  
 St. Vincent, 84, 107, 109, 138, 192, 196  
 Suffolk, 58  
 Sunderland, 105  
 Surat, 98  
 Surinam, 98, 187  
 Surrey, Eng., 197

Susquehanna, 188, 190  
 Suttons, Essex Co., 200  
 Sweden, 25, 65, 130, 139  
 Sydney, Australia, 83, 84  
 Syracuse, 27  
 Tabasco, 136, 173  
 Tacumshane, Ire., 40  
 Tagus River, 47, 201  
 Tahiti, 83, 84  
 Taku, 212  
 Tampico, Mexico, 212  
 Tasmania, 83, 91  
 Taunton, Eng., 47  
 Tavistock, 116  
 Teneriffe, 47, 88, 138  
 Tennessee, 81, 82, 88  
 Texas, 61, 123, 124, 149, 204, 207  
 Texel, 74  
 Thames River, 47, 149  
 Thompson, Conn., 135  
 Ticonderoga, 15, 23, 71, 72, 73, 105  
 Tobago, 112, 113  
 Torres Strait, 83, 84  
 Toulon, 76, 93, 95, 138, 140, 142, 201  
 Trafalgar, 1, 20, 59, 91, 93, 108, 139, 141, 142, 144, 158, 159  
 Trenton, N. J., 40, 54, 118, 119, 204  
 Tripoli, 68, 69, 118, 134, 136, 177, 181, 182, 190, 191, 195  
 Troy, 173, 187  
 Tunis, 47, 166, 182, 187, 191  
 Turkey, 36, 182  
 Tuscany, 182  
 Tuxpan, 175, 208, 209  
 Typee, 177  
 Upsala, Sweden, 65  
 Uruga, Japan, 166  
 Ushant, 192  
 Utah, 34  
 Valparaiso, Chile, 67, 79, 80, 97, 133, 177, 178, 191, 207, 209  
 Vancouver Island, 100, 133

Vera Cruz, 53, 96, 175, 193, 198, 207, 208, 214  
 Vermont, 71, 73, 135, 173  
 Vicksburg, Miss., 66, 68, 79, 175  
 Virginia, 38, 79, 110, 111, 112, 124, 126, 151, 152, 154, 177, 183, 211

Walby, 105  
 Wales, 115  
 Wass, 65  
 Washington, D. C., 36, 53, 62, 66, 67, 70, 87, 150, 151, 153, 154, 170, 175, 190, 191, 193, 203, 206, 207, 211  
 Waterloo, 42, 43, 132  
 Waterloo, 103, 114, 116  
 Waterville, Me., 150  
 Westfield, Mass., 73  
 West Indies, 23, 36, 40, 44, 51, 52, 54, 58, 79, 82, 86, 88, 90, 97, 98, 104, 107, 118, 121, 127, 129, 133, 137, 138, 140, 142, 143, 144, 154, 163, 175, 177, 178, 179, 183, 193, 194, 195, 198, 207, 210  
 Westminster, 127, 129, 201  
 West Point, N. Y., 30, 61, 66, 86, 111, 125, 126, 169  
 Whitehaven, 112  
 White Plains, N. Y., 122  
 Wilmington, N. C., 122, 175, 212  
 Wiltshire, Eng., 200  
 Winchester, Eng., 116, 128  
 Windsor, 116, 127, 128  
 Windward Isles, 41  
 Winwick Church, 100, 102  
 Wisconsin, 20, 62  
 Woodstock, Conn., 134, 135, 136  
 Worcester, Eng., 200  
 Worcester, Mass., 44, 45, 46, 170  
 Wreck Reef, 84  
 Yokohama, 116  
 York, Eng., 96, 127, 128, 159  
 York, Me., 183  
 Yorkshire, 127  
 Yorktown, 20, 57  
 Zanesville, Ohio, 20, 62

## NAMES OF VESSELS.

Adams, 134, 136, 163  
 Agamemnon, 138  
 Alabama, 123, 180, 182, 198  
 Albemarle, 60, 61, 137  
 Alcide, 201  
 Alert, 177  
 Alfred, 112

Alliance, 40  
 Alligator, 44, 55  
 Amason, 133, 158  
 Amphitrite, 133  
 Antelope, 196  
 Apollo, 157  
 Arkansas, 180

Atlanta, 190  
 Aurora, 179  
 Avenger, 130  
 Baltimore, 104  
 Barclay, 80  
 Barfiour, 59

Basilisk, 133  
 Beaufort, 151  
 Bellerophon, 83, 91, 117  
 Belvidere, 188, 189, 203  
 Berwick, 95  
 Black Prince, 40  
 Blake, 62  
 Blenheim, 78  
 Bonaventure, 96  
 Bon Homme Richard, 38, 112  
 Boreas, 138, 145  
 Brandywine, 134, 162, 167  
 Bristol, 196  
 Brittainia, 42  
 Brooklyn, 45, 46, 126, 173, 198  
 Burford, 104  
  
 Cabot, 99  
 Cæsar, 196  
 Carleton, 157  
 Caroline, 151  
 Cayuga, 160  
 Cecile, 122  
 Centaur, 215  
 Chatsworth, 86  
 Cherub, 177  
 Chesapeake, 46, 64, 110, 118, 164  
 Chicago, 125  
 Chickasaw, 160  
 Chippewa, 172  
 Cleopatrie, 157  
 Colorado, 46, 62  
 Condor, 42  
 Confederacy, 127  
 Congress, 62, 63, 125, 151, 204  
 Conqueror, 159  
 Constellation, 121, 154, 177, 187, 188, 198, 207  
 Constitution, 36, 38, 44, 45, 88, 90, 122, 134, 181, 189  
 Cornwall, 104  
 Countess of Scarborough, 112  
 Crescent, 196  
 Crusader, 122  
 Cumberland, 151, 152, 154, 211  
 Cyane, 160, 164  
 Cyrene, 193  
  
 Dash, 183  
 Deerhound, 123  
 Delight, 179  
 Diana, 164  
 Diligence, 148  
 Dolphin, 122, 154  
 Dorothea, 91  
 Drake, 112, 113  
 Droits de l'Homme, 158  
  
 Eagle, 62, 192  
 Effingham, 40  
 Endymion, 69  
 Enterprise, 68, 118, 120  
 Erebus, 91  
 Erie, 203, 207  
 Esmeralda, 179  
 Essex, 22, 79, 80, 177, 178, 179  
 Experiment, 44, 51, 177, 178

Falcon, 184  
 Falmouth Packet, 148  
 Federal, 207, 208  
 Fern, 212  
 Florida, 122  
 Fortune, 174  
 Fox, 131  
 Francis, 83  
 Frolic, 169, 189  
  
 Gabriel, 97  
 Gaspé, 99  
 General Arnold, 51  
 General Greene, 165  
 George, 51  
 Glasgow, 98, 99  
 Globe, 154  
 Gorgan, 131  
 Gosport, 76  
 Grampus, 86  
 Gregson, 51  
 Guerrière, 88, 90, 134, 203  
  
 Hannah, 51  
 Hannibal, 148, 149  
 Harmony, 187  
 Hartford, 79  
 Hatteras, 180  
 Havana, 134  
 Hawke, 98  
 Hebe, 93  
 Hector, 98  
 Helena, 93  
 Hinchenbrook, 137  
 Hornet, 37  
  
 Impérieuse, 129  
 Indefatigable, 158  
 Independence, 36  
 Indiana, 126  
 Inflexible, 198  
 Intrepid, 51, 68, 131  
 Investigator, 83, 91  
 Invincible, 168  
 Iowa, 169  
  
 Jackal, 207  
 Jane, 187  
 Java, 36  
 Jersey, 90, 136, 148, 179, 181  
 John, 112  
 John Adams, 81, 86, 187  
 Judith, 46  
  
 Kearsarge, 62, 123, 182, 198, 212  
 Kennebec, 46  
  
 Lackawanna, 160  
 Lawrence, 165, 166, 167  
 Leopard, 46, 164  
 Lexington, 40  
 L'Insurgente, 121, 177, 187, 188, 189  
 Lion, 146  
 Little Belt, 162, 188, 189  
 Lowstoft, 137

Macedonia, 69, 207  
 Machias Liberty, 148, 149  
 Madison, 183  
 Magnanime, 104  
 Margaretta, 148, 149, 150  
 Martha, 86  
 Mary Rose, 186  
 Maumee, 60  
 Merrimac, 39, 51, 53, 62, 63, 109, 151, 208  
 Meshboha, 36  
 Meshouda, 69  
 Minerva, 93  
 Minnesota, 60  
 Mishouri, 203  
 Mississippi, 53, 70, 71  
 Monarch, 74  
 Monitor, 39, 53, 109, 151, 154, 193, 208  
 Montauk, 172  
 Mutine, 93  
  
 Nanny, 51  
 Nassau, 123  
 New London, 160  
 New York, 172  
 Niagara, 167  
 Niger, 58  
 Norfolk, 83  
 Norwich, 74  
 Nottingham, 196  
 Nymphe, 157  
  
 Ohio, 204  
 Orient, 196  
 Orion, 196  
  
 Pallas, 112  
 Patrick Henry, 211  
 Patriotic, 64  
 Pawnee, 172  
 Pennsylvania, 79, 211  
 Perry, 44, 86, 167  
 Petrel, 50, 184  
 Philadelphia, 36, 68, 69, 120, 134, 177, 181, 187  
 Phoebe, 51, 177, 178  
 Phoenix, 211  
 Plantagenet, 203  
 Plymouth, 64  
 Polyphemus, 91  
 Portsmouth, 87  
 Potomac, 151  
 Powhatan, 175  
 President, 69, 136, 162, 188, 203  
 Prince George, 77  
 Princess Augusta, 93  
 Princeton, 204  
 Protector, 181  
 Providence, 83, 112  
 Puritan, 170  
  
 Queen, 49  
  
 Raisonnable, 137  
 Raleigh, 114  
 Ranger, 112, 113



Rattler, 60  
 Release, 160  
 Relief, 160  
 Resolute, 66  
 Retaliation, 36  
 Reunion, 196  
 Revenge, 162, 164  
 Rhode Island, 193  
 Robust, 76, 215  
 Romney, 76  
 Russel, 196  
 Sacramento, 118  
 Sandwich, 88  
 Santa Anna, 59  
 Saratoga, 37, 207, 209  
 Scioto, 160  
 Scorpion, 165  
 Sea Flower, 51  
 Sea Nymph, 51  
 Seminole, 193  
 Serapis, 112  
 Severn, 104

Shannon, 59, 118  
 Somers, 198  
 Spitfire, 175  
 Stanislas, 157  
 Stately, 41  
 St. Lawrence, 154  
 St. Louis, 184  
 Stromboli, 211  
 Sumpter, 160, 198  
 Superb, 215  
 Susquehanna, 53, 182  
 Swallow, 98  
 Tecumseh, 79, 161, 182, 184  
 Tennessee, 53, 79, 160, 161  
 Terrible, 200  
 Terror, 91  
 Texas, 172, 173  
 Theseus, 103  
 Ticonderoga, 154  
 Tigre, 201  
 Trent, 91  
 Trenton, 88

True-blooded Yankee, 183  
 Trumbull, 90  
 Trusty, 214  
 United States, 41, 68, 69, 86, 154  
 Unity, 148, 149, 150  
 Varmans, 118  
 Victor, 33  
 Victory, 93, 102  
 Vigilant, 149  
 Virginia, 109, 208  
 Vixen, 23, 181, 193, 209  
 Viscaya, 173  
 Vulcan, 98  
 Wabash, 154  
 Wasp, 37, 168, 189  
 Weehawken, 180, 191  
 Winthrop, 181  
 Wizard, 103

## TRAITS.

Activity, 45, 56, 103, 113, 135, 140, 157  
 Administrativeness, 43, 49, 88, 97, 105, 107, 151, 162, 174, 188, 201  
 Adventurousness, 33, 36, 42, 43, 51, 54, 61, 70, 81, 87, 90, 92, 96, 120, 122, 129, 133, 146, 152, 155, 163, 164, 175  
 Aggressiveness, 87  
 Ambitiousness, 113, 139, 143, 146, 185  
 Artistic Sense (form), 65, 101, 135, 155, 178, 182, 193, 194, 195, 199  
 Audacity, 61, 87, 88, 163, 179  
 Austerity, 41  
 Bravery, 37, 71, 82, 83, 96, 157, 161, 163, 201  
 Brilliance, 101, 103, 158  
 Buoyancy, 41, 103, 155  
 Carefulness, 85  
 Chivalry, 36, 212  
 Claustrophobia, 27  
 Combativeness, 56, 114, 152, 155, 161, 163, 175, 177, 190  
 Constructiveness, 109  
 Courage, 36, 38, 41, 42, 59, 62, 94, 127, 135, 155, 161, 163, 165, 198  
 Dash, 212  
 Decisiveness, 122, 127, 163  
 Diplomacy, 36, 77, 94, 97, 135, 156, 166, 204, 208  
 Energy, 38, 107, 120, 139, 145, 163, 176, 201, 212  
 Enthusiasm, 38

Fearfulness, 29, 139  
 Fearlessness, 36, 38, 61, 99, 105, 118, 122, 123, 127, 129, 149, 155, 161, 163, 164, 165, 166, 188, 208, 212  
 Firmness, 41, 59, 109, 122, 163  
 Fortitude, 212  
 Gallantry, 39, 42, 45, 153  
 Generosity, 85, 103, 118, 123, 132, 202, 209  
 Hunting, fondness for, 212  
 Independence, 163  
 Indolence, 145  
 Industry, 85  
 Intelligence, 122, 123  
 Intrepidity, 38, 84, 175  
 Inventiveness, 39, 57, 65, 130, 202  
 Jocularly, 43, 61, 129, 172  
 Judiciousness, 36, 40, 59, 65, 82, 92, 101, 120, 127, 162, 176, 208  
 Legislative Ability, 44, 45, 54, 89, 114, 151, 195, 199  
 Literary Ability, 130, 177, 182, 199  
 Love of Hunting, 42, 43, 44, 47, 101, 127, 161, 164  
 Militarism, 25, 37, 43, 54, 61, 68, 71, 74, 88, 95, 103, 105, 109, 120, 134, 146, 151, 161, 197  
 Nomadism, 27, 28, 31, 37, 38, 41, 64, 65, 84, 101, 113, 131, 146, 155, 173, 175, 182, 202, 205, 211, 212  
 Obstinacy, 178  
 Orderliness, 190

Perseverance, 212  
 Pertinacity, 37, 92, 143, 161, 166  
 Promptitude, 40, 69, 94, 97, 179  
 Quarrelsomeness, 56  
 Recklessness, 43, 158  
 Religiousness, 141, 145, 167, 183  
 Resourcefulness, 120  
 Responsibility, 37, 38, 53, 133, 139, 163, 167, 191  
 Responsiveness, 38, 70, 172, 173, 209  
 Restlessness, 29, 56, 61, 82, 101, 103, 133, 201, 205  
 Scholarship, 36, 41, 47, 50, 65, 77, 85, 87, 89, 99, 101, 167, 186  
 Self-control, 92, 112  
 Self-reliance, 49, 53, 81, 87, 88, 120, 167  
 Strategic Insight, 29, 81, 101, 135, 142  
 Sternness, 192, 199  
 Tactical Ability, 29, 105  
 Temper, 38, 40, 41, 43, 92, 101, 113, 140, 166, 178, 181  
 Tenacity, 144, 176  
 Thallasophilia, 25, 26, 27, 28, 29, 31, 33, 36, 48, 49, 56, 64, 68, 69, 81, 88, 93, 96, 99, 101, 107, 118, 129, 135, 151, 152, 161, 178, 179, 181, 190, 200, 201, 207  
 Vigilance, 103  
 Visualism, 26, 130, 131  
 Vivacity, 85, 86  
 Wanderlust, 25, 29, 90 (see Nomadism)  
 Wit, 38, 42, 123, 149



LANE MEDICAL LIBRARY

To avoid fine, this book should be returned on  
or before the date last stamped below.

--	--	--





